



Seeing beyond

Mobile Measurement & Inspection Cells

High-speed, modular, feature-based



The best fit for your production line

The mobile measuring and inspection cells from ZEISS are characterized by their high precision and flexibility. They are able to perform measurements with high accuracy and can be used at different locations to perform measurements on site. With their high accuracy, they are ideal for quality assurance in production, checking surface and measuring parts. The systems are modular and can be used in two stages: after starting measuring atline, the subsequent inline integration is possible at any time.

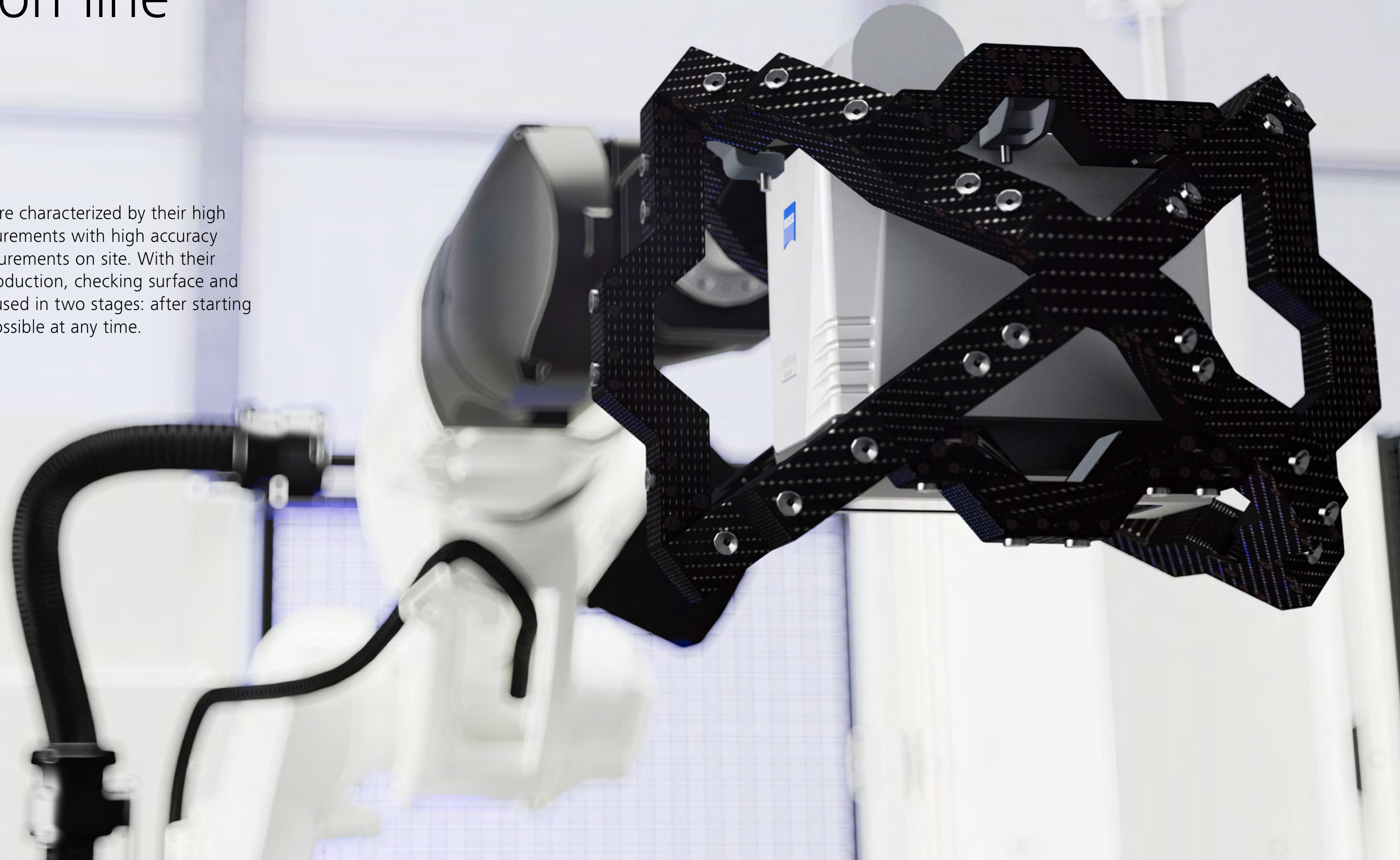

The most important features

- Quality assurance both in the context of **production ramp-up** and in **serial production**
- A gradual use of the new cells **starting with the atline** solution and a **later integration into the production line**
- **Highly flexible & high speed** measuring and inspection technology
- Use of **proven and high-quality technologies** from ZEISS in the mobile measuring and inspection cells



Modular and flexible

One mobile cell – many expansion options



Option 1: Mobile cell

Including industrial robot, sensor, hose package, pc control cabinet, software package, mobile carrier platform, integrated grid plate, safety fence with pivoting door and hand scanner for component verification.

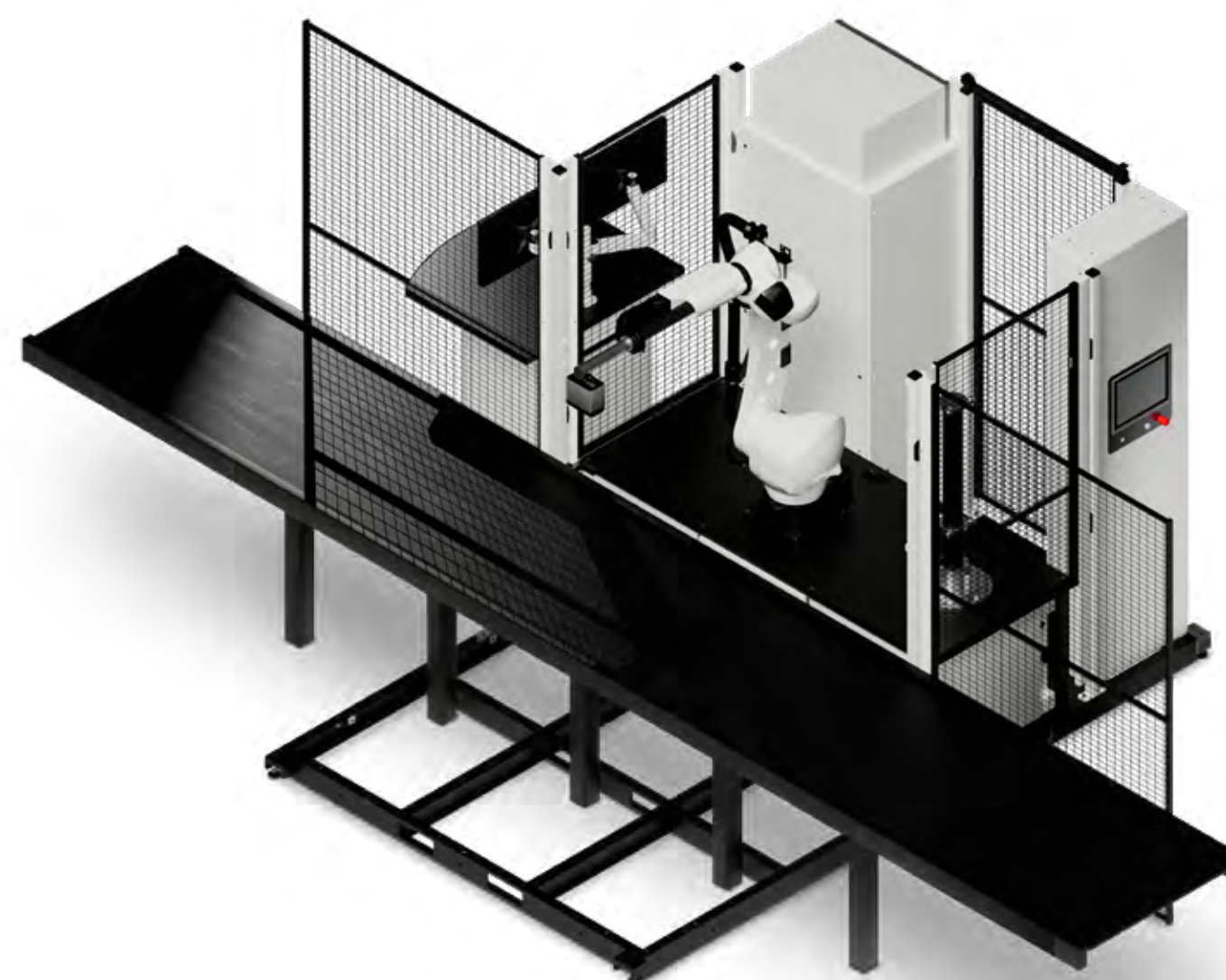

Option 2*: Inline application

Including preparation for system integration and provision of interfaces, plus extended safety logic for inline use.
Not included: system-specific control and safety technology, PLC connection and CE conformity of the system.

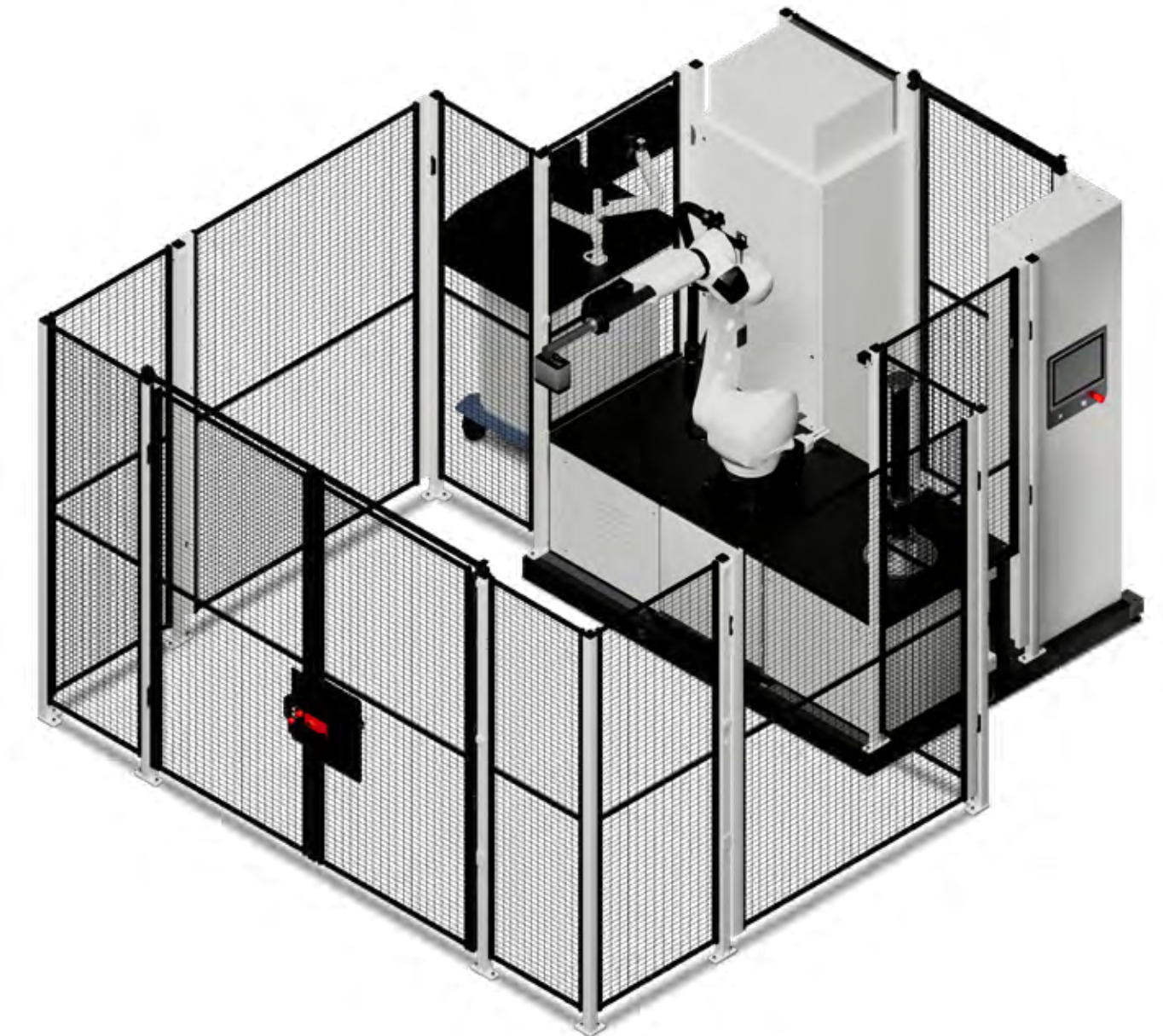

Option 3*: 2D component verification

Option 4*: Enlargement of the cell

* Special design, requires customer-specific consultation

Grows with requirements

Benefits and added value

- The mobile measuring or test cell offers the customer **a closed and flexible overall solution**
- If necessary, the cell with the integrated carrier platform **can be easily moved to another location**
- The cell **can be used strategically very early in the production ramp-up phase (Atline)** and then **integrated into the production line (Inline)**
- If measurement plans and components are already available, **the measurement points can be programmed by ZEISS before delivery to the customer**



Systems

ZEISS AIMax cloud

Optical sensor for 100% measurement

- Optical 3D sensor
- Robot-based 3D inline or atline metrology
- For sheet metal processing and car body construction
- Generates 3D point clouds
- Measures complex features with high precision in a fraction of a second

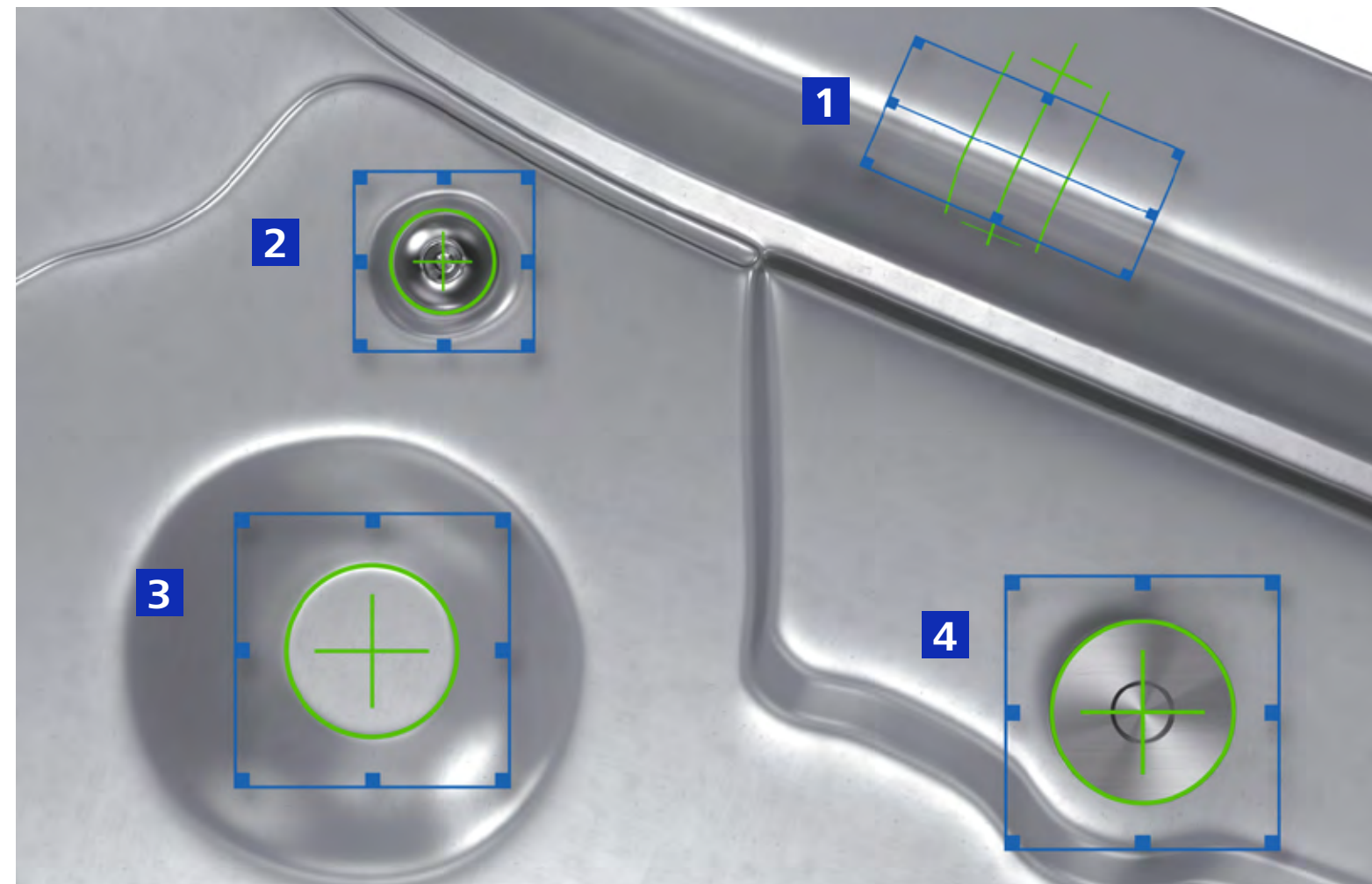

Examples of features: (1) Bending edge, (2) rivet, (3) surface point, (4) T pin

[> More informations](#)

ZEISS AICell trace

Correlation-free and metrologically traced inline metrology

- Correlation-free inline measuring cell
- Real-time process monitoring of complex features
- Ramp-up support of the car body production processes
- Elimination of all mechanical drift and temperature impact of the robot from the measurement results
- System accuracy is independent from robot's ability to accurately locate the measurement sensor



Stability modules on the ground are fixed reference for the tracking system even with temperature fluctuations in the production environment.

[> More informations](#)

ZEISS ABIS III

Automated surface inspection

- Tailored solution for surface inspection in the press shop and body shop
- Reliable and early detection of defects
- Objective evaluation and classification of a wide range of defects
- Perfect quality assurance tool
- High precision and extremely short cycle times

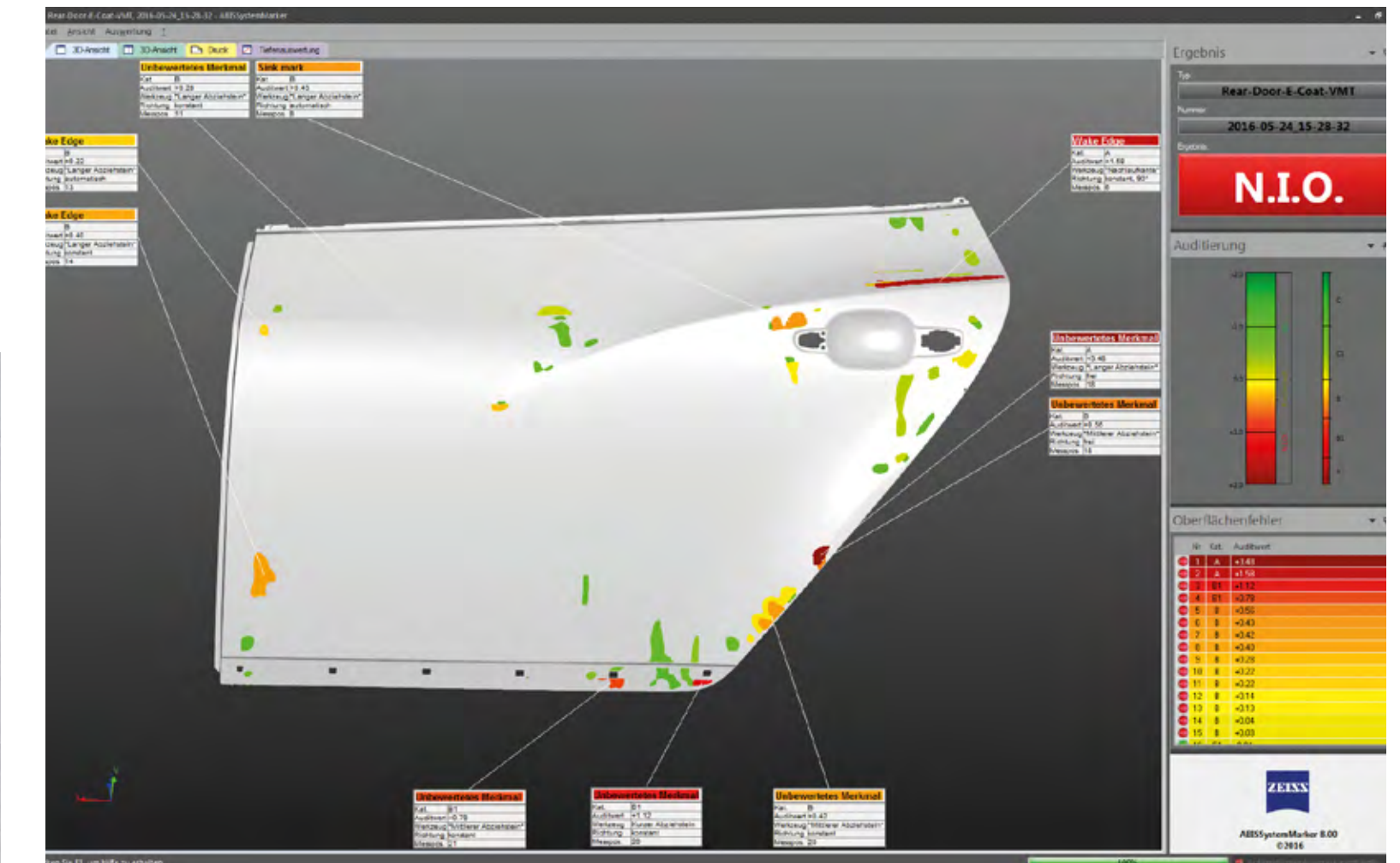

The system, which is designed for industrial use, easily inspects moving components and is therefore ideally suited for inline use.

[> More informations](#)

Applications

Automotive

- Structural Components
- Hang-On Parts
- Exterior & Interior Components
- ...

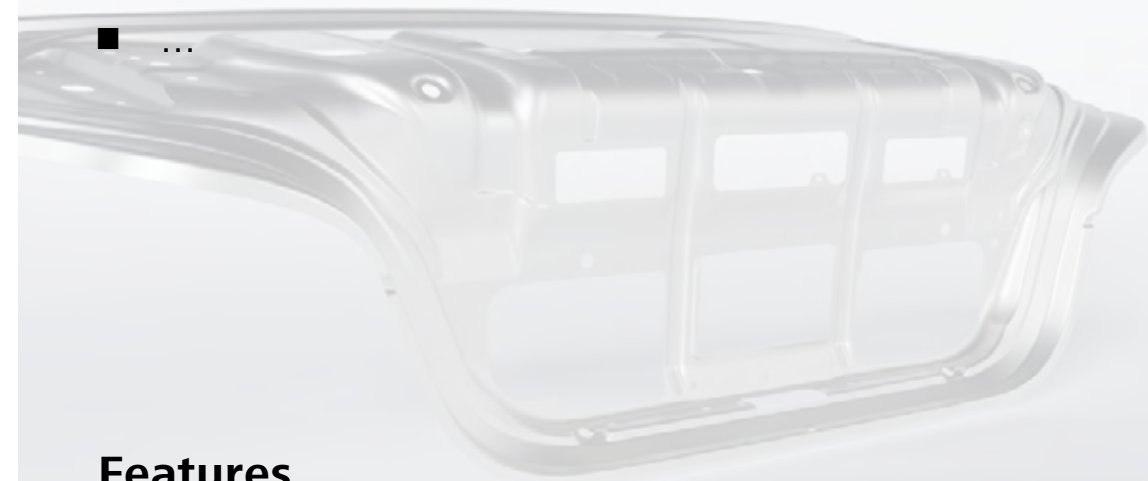

Features

- Positioning and Geometry
- Bolts and Rivets
- Drillholes
- Surface Defects

New Energy Vehicle

- Battery Trays
- Electric Motor Components
- Structural Components
- ...

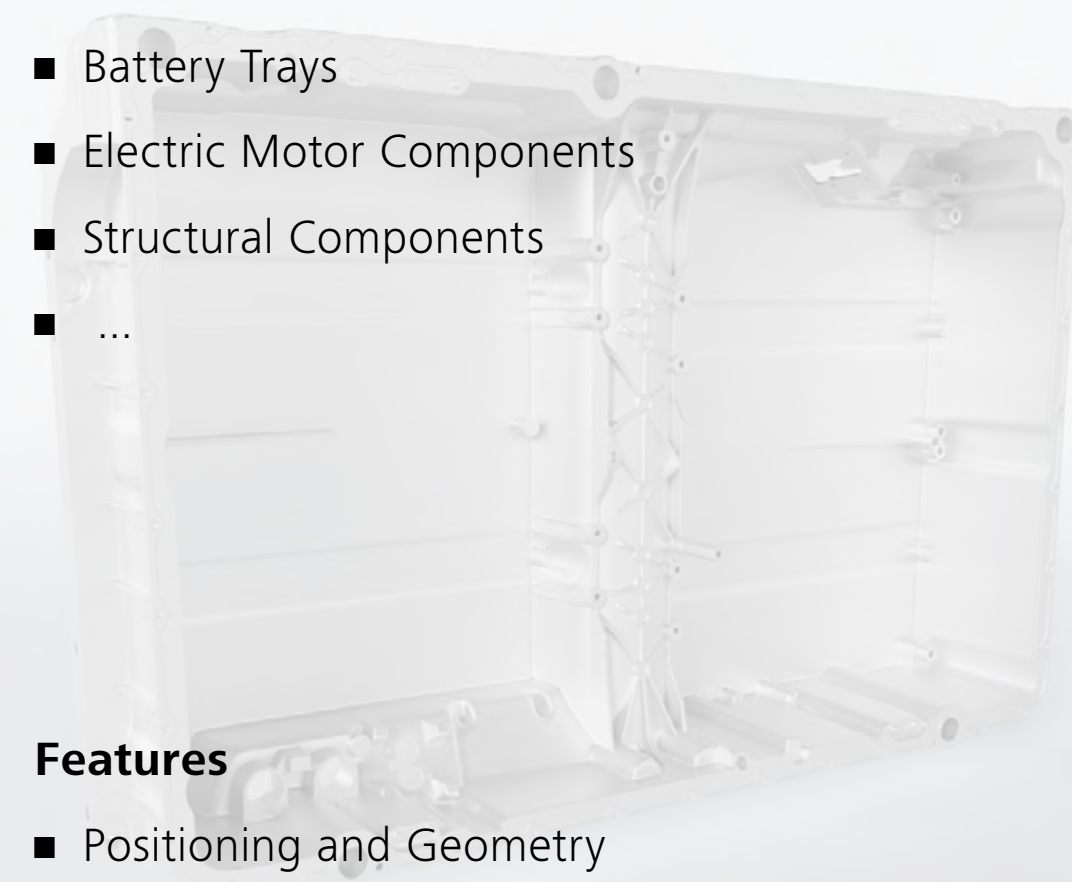

Features

- Positioning and Geometry
- Bolts and Rivets
- Drillholes
- Surface Defects

Bicycle and Motorbike

- Frame Components
- Beams
- Structural Components
- ...

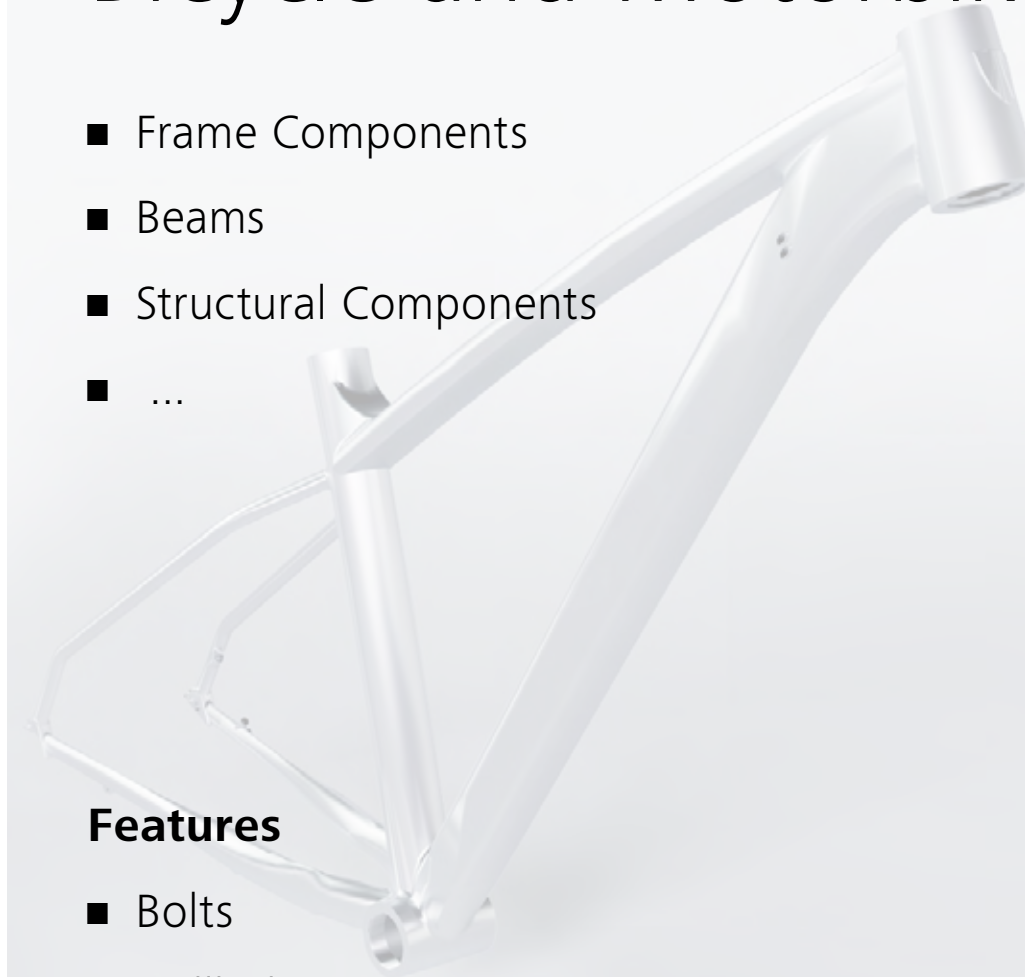

Features

- Bolts
- Drillholes
- Geometries

White Goods

- Household Appliances
- Washing Machines
- Dryer
- ...



Features

- Surface Defects
- Structures
- Positioning and Geometry

Technical data

Dimensions

ZEISS AImax cloud

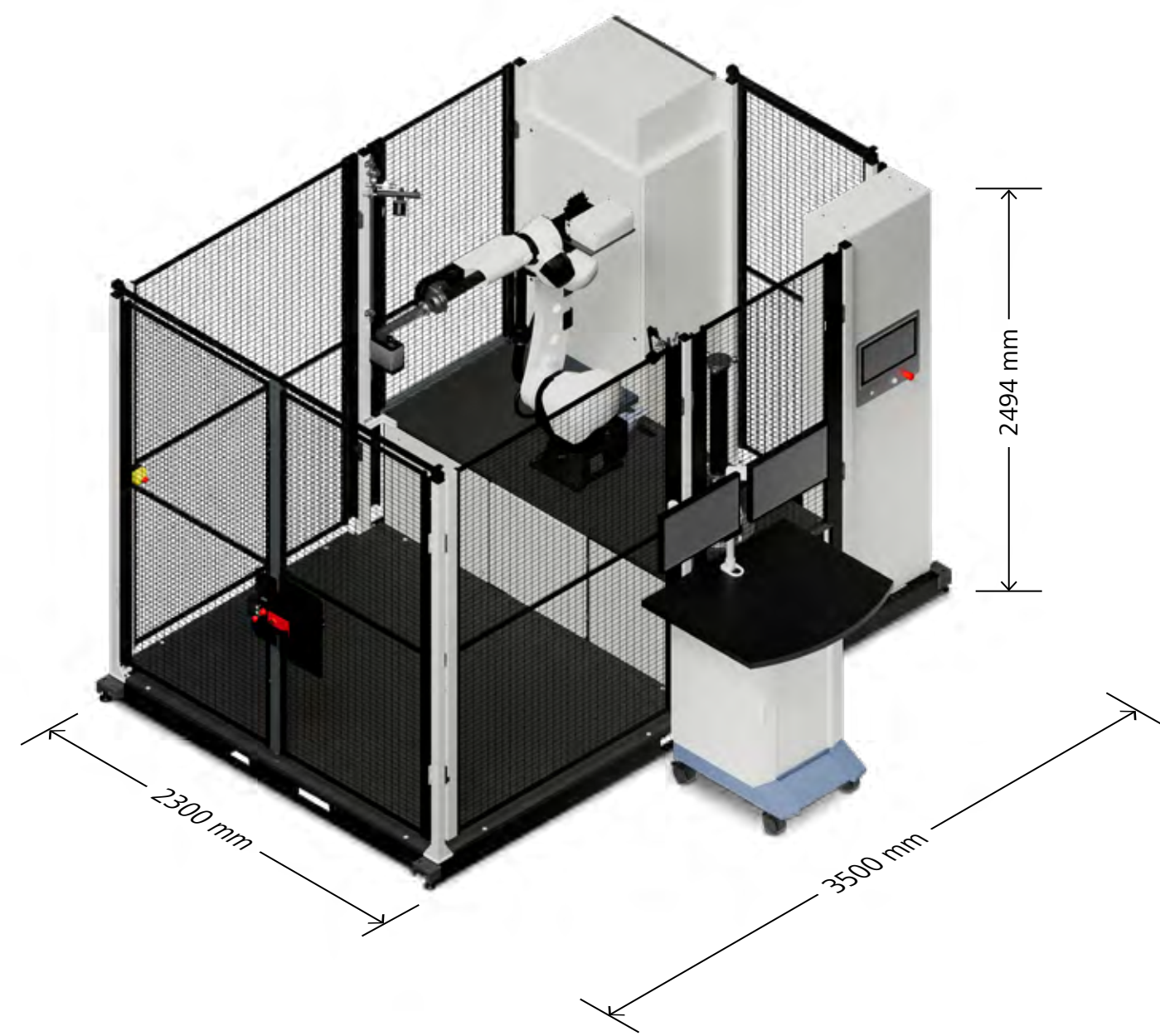

ZEISS AICell trace

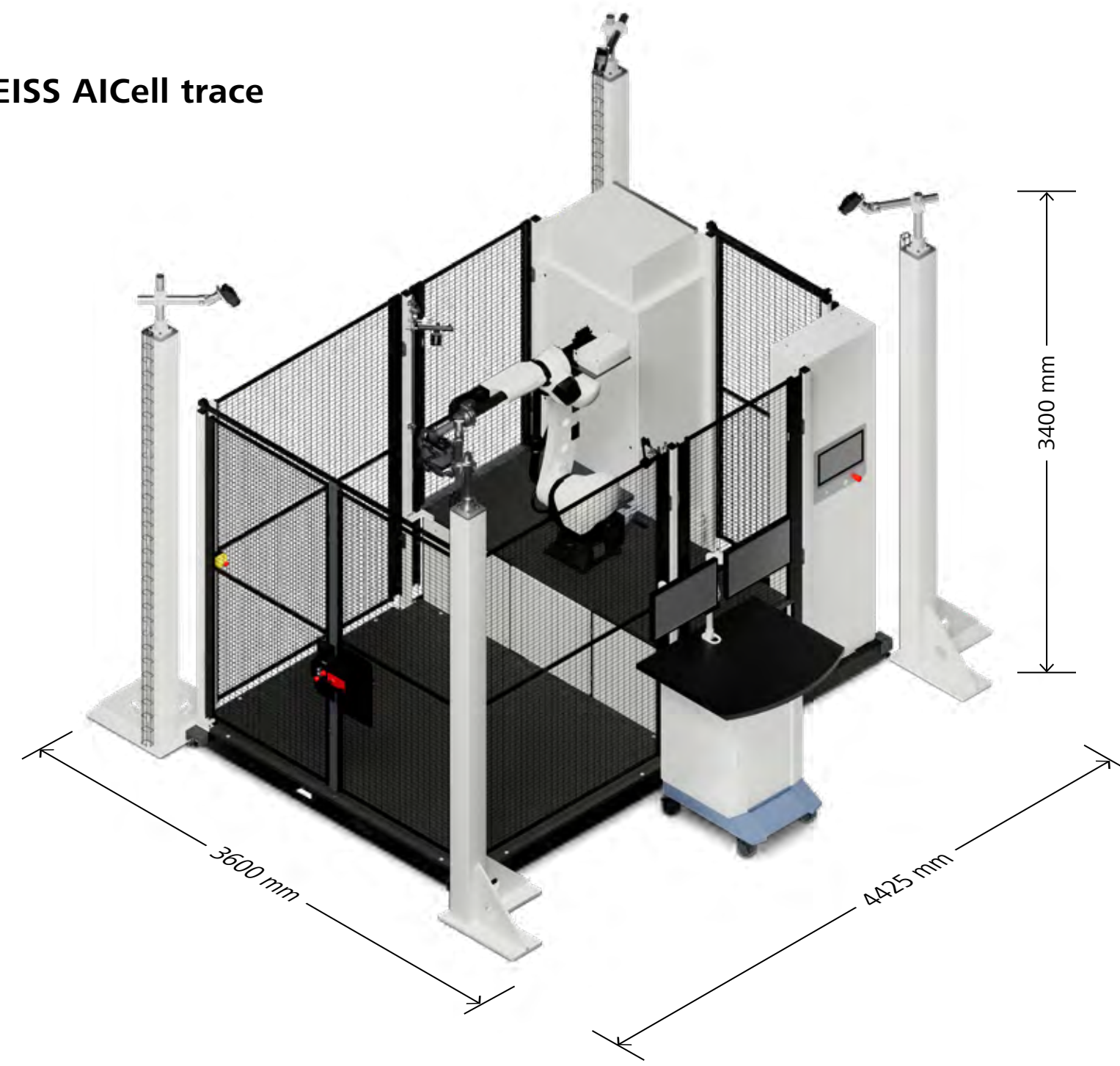

ZEISS ABIS III

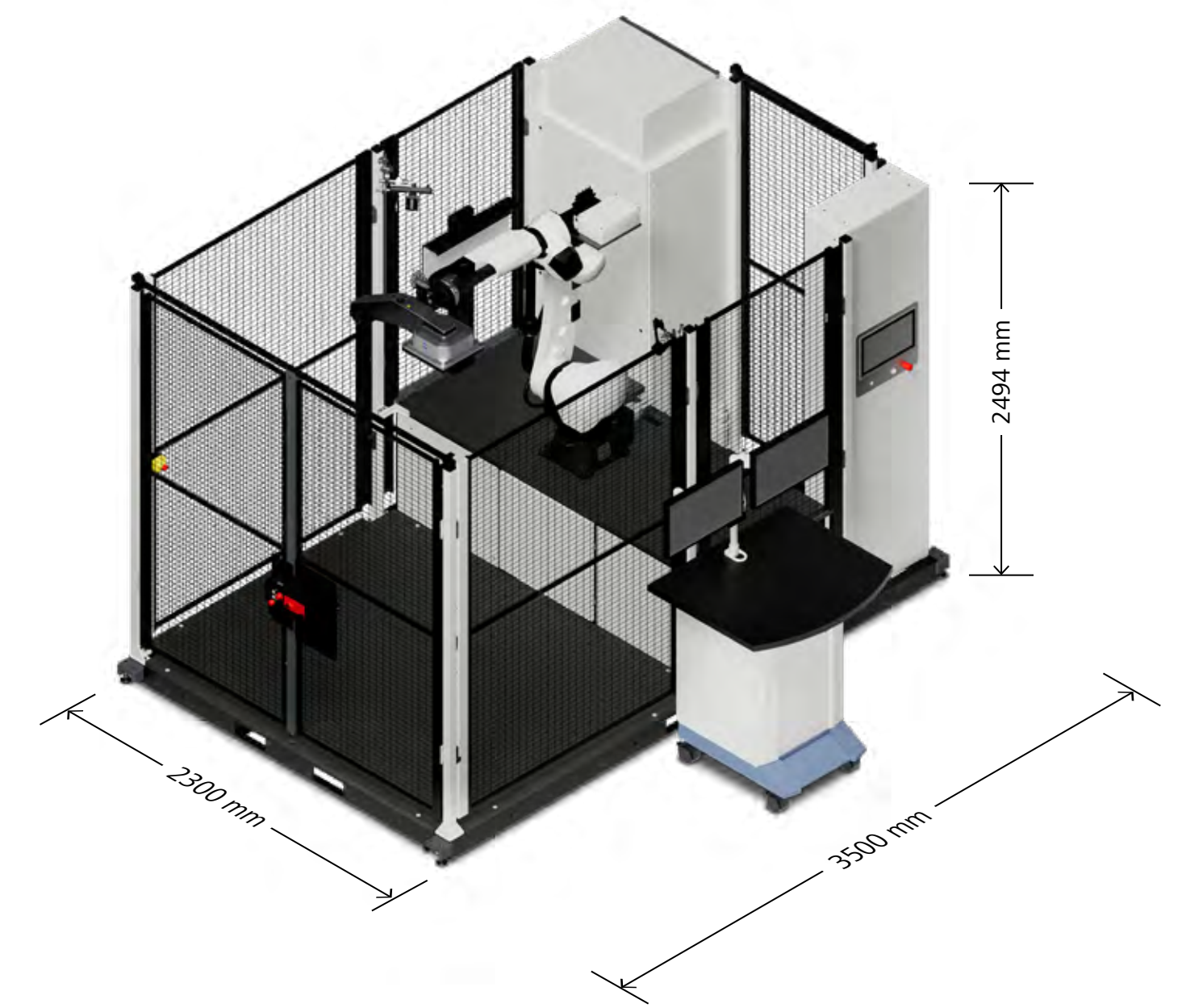



Seeing beyond