

Quality Assurance for eMobility

ZEISS eMobility Solutions

ZEISS

Seeing beyond



zeiss.com/emobilitysolutions

Driving Quality Forward

New Energy Vehicle safety and performance

Manufacturers on the global market for new energy vehicles (NEVs) must handle constantly evolving requirements and rapidly growing demand. Core components such as batteries and electric motors are of critical importance in ensuring the safety of NEVs and enhancing their output, range, and structure.

In order to move with the times while maintaining the highest standards in safety and performance, manufacturers must establish sophisticated holistic quality assurance processes for NEV production. Consistent high quality will enable them to master new challenges, avoid bottlenecks, and occupy a leading role in the ongoing transition to electric mobility.

Your One-Stop NEV Partner

Holistic solutions from ZEISS

ZEISS eMobility Solutions has over 1,000 customers in the global electric vehicle sector. With our application-oriented approach and comprehensive product portfolio, we are the leading partner at every stage of the process and empower the change within this evolving industry.

Battery

- Battery Materials
- Battery Electrodes
- Battery Cells and Modules
- Battery Tray

Page 06

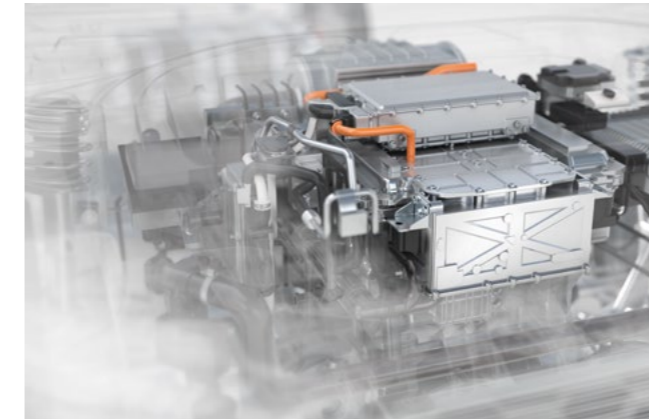

Fuel Cell System

- Bipolar Plate
- Membrane Electrode Assembly
- Peripheral Components

Page 34



Automotive Electronics

- Semiconductors
- Printed Circuit Board
- Housing and Connectors

Page 44



Electric Motor

- Hairpins
- Sheet Stacks
- Stators
- Rotors and Shafts

Page 20

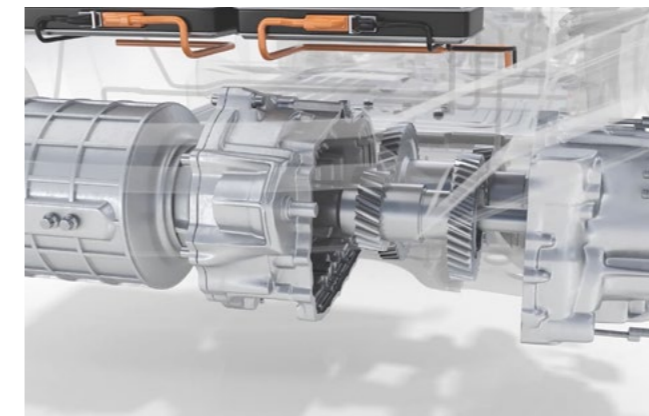
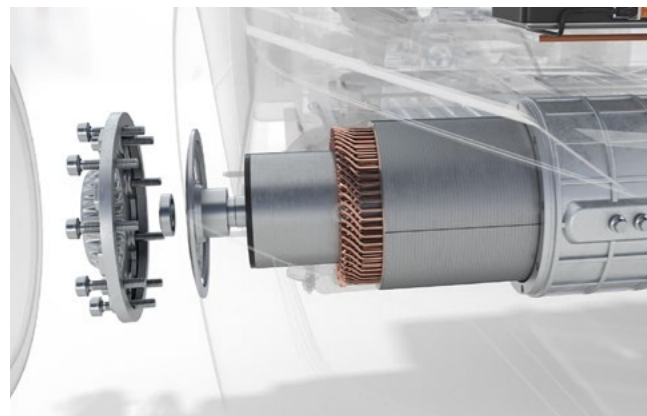

Transmission

- Gears
- Housing

Page 50



Battery Quality Management

Ensuring superior long-term performance

Batteries are key to the range, performance, and longevity of NEVs. Reliable and long-lasting batteries require top-class materials and precise production techniques. They are also at the heart of a wide range of quality management applications from initial development onward. Battery cells, modules, and trays must comply with very tight tolerances during final assembly.

From industrial microscopy and computed tomography (CT) to coordinate measuring machines (CMMs) and optical 3D measurement systems, the ZEISS portfolio features a range of sophisticated hardware and software solutions. These capture the quality data required to ensure battery safety and performance for electric vehicles.

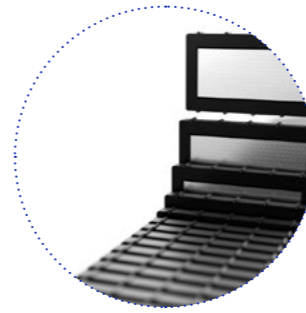

Battery Electrodes
Technical cleanliness
[Page 10](#) →

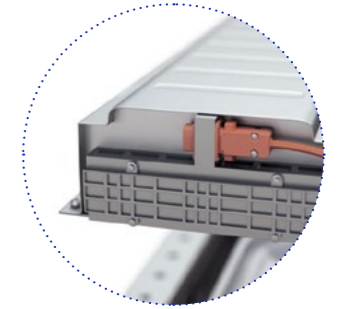

Battery Cells and Modules
Fast, high-resolution
inspection
[Page 12](#) →

Battery Tray
Inspection of structure
and integrity
[Page 14](#) →

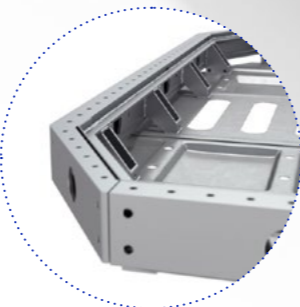

Battery Materials
Material and structure
development
[Page 08](#) →



→ Find the perfect product for your application: [page 54](#)

Quality Assurance for Battery Materials

Material structure development and raw material processing

Among all of the elements in an NEV, the battery system has the largest impact on the driving experience. Battery performance is highly influenced by raw materials, with material and structure development playing a key role in this regard. Particular challenges include developing new active materials, ensuring a uniform and consistent supply, maintaining proper calendaring pressure, and observing microscopic changes caused by aging.

Recipe Development

Quality Challenges

- Capacity, charging behavior, and battery lifetime all defined by materials used for cathode, anode, and separator
- Cell performance is highly influenced by microscopic material structure, particle chemical composition, and impurities

ZEISS Solutions

- Determine relevant material properties with ZEISS electron and X-ray microscopy (XRM) for enhanced battery performance
- Efficient correlative analysis via a patented correlative microscopy solution incorporating light microscopes and SEMs

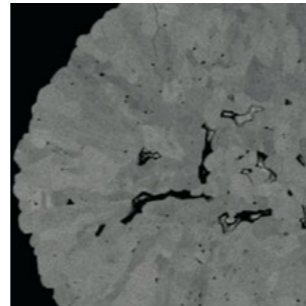

Supply Chain Control

Quality Challenges

- Ensure uniformity and consistency via incoming goods check: avoid impaired performance and efficiency
- Avoid battery failure by checking raw material microstructure, plus the purity of electrode materials and their chemical compositions

ZEISS Solutions

- Sub-nanometer imaging, analytics, and sample flexibility with ZEISS GeminiSEM
- Complete sample preparation workflow for fast, clear, and seamless imaging of the material microstructure
- Analyze entire batteries with ZEISS X-ray microscopy to ensure uniform supply

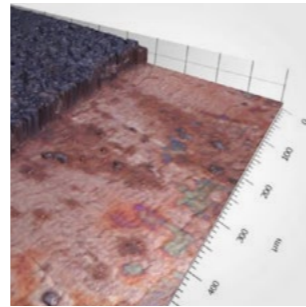

Calendering Pressure

Quality Challenges

- Void and crack formation in the electrodes caused by poor material mixing and non-uniform calendaring pressure
- Variations in calendaring pressure lead to unequal particle packing density and electrode porosity

ZEISS Solutions

- Timely detection and countering of negative effects via inspection with ZEISS 3D X-ray microscopy (XRM)
- Avoid cell issues such as suboptimal energy, poor charging capacity, and impaired electrochemical performance

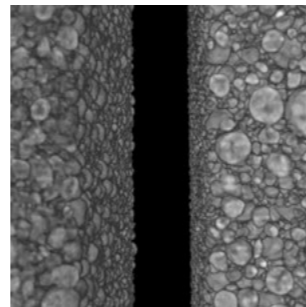

Lifetime and Aging Effects

Quality Challenges

- Understanding longitudinal aging effects is key to addressing performance fluctuations during battery lifetime
- Continuous electrode particle expansion during (dis)charging causes cracks, lower mechanical stability, and loss of electrical contact between active materials

ZEISS Solutions

- Nondestructive imaging of microstructure with ZEISS microscopes reveals changes due to (dis)charging
- Respond to reduced capacity and potential cell failure via microscale electrical property mapping with ZEISS electron microscopy

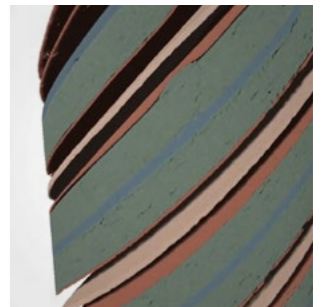

Quality Assurance for Battery Electrodes

Burr inspection and technical cleanliness

The geometry and composition of electrodes inside battery cells play a major role in safety and efficiency. To prevent safety issues and meet strict quality standards, the cutter blade used in the electrode cutting process must be inspected and replaced in a timely manner. Since there is a high risk of particle contamination that can affect battery lifetime and quality, it is essential to detect this and identify the root cause via technical cleanliness.

Burr Inspection

Quality Challenges

- Metal burrs generated during electrode cutting process can impair battery performance
- Cutter blade changes must therefore be perfectly timed to balance battery quality and production cost

ZEISS Solutions

- High-resolution quality lab inspection of cut electrodes with ZEISS optical multisensor CMMs
- Real-time monitoring of high-speed electrode cutting and stacking via ZEISS optical inline metrology
- Automated burr detection in factory environments with the ZEISS burr inspection system

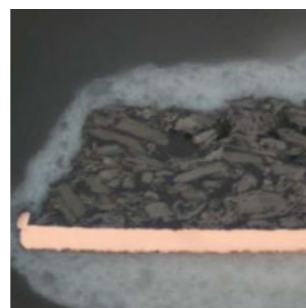

Technical Cleanliness

Quality Challenges

- High contamination risk during transportation and production: need to detect foreign particles larger than 5 µm
- For root cause identification, it is essential to distinguish between particle types, chemical compositions, and origins

ZEISS Solutions

- Establish advanced workflow to identify contamination and root cause with ZEISS Correlative Particle Analysis
- Distinguish metal, fiber, and non-metal particles with ZEISS Technical Cleanliness Analysis to estimate contamination risk
- Find root cause of contamination with ZEISS SEMs that automatically state the chemical composition of each particle

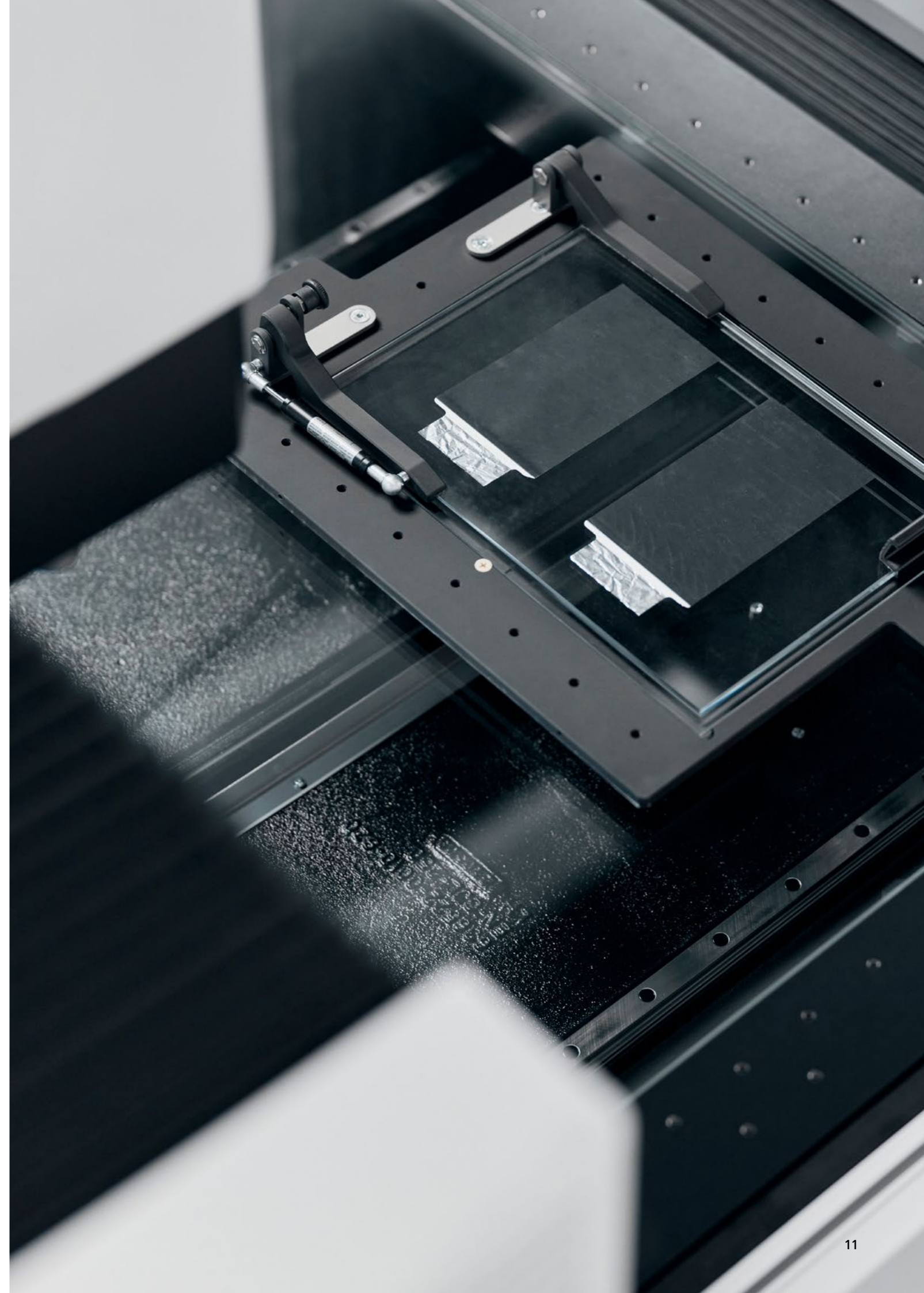

Quality Assurance for Battery Cells and Modules

Battery cell production and assembly

Final inspection of the complete battery module is a particularly challenging process, as the individual cells in such modules pose a number of safety risks and quality challenges. Fast test cycles with high resolution are required for all three cell types – cylindrical, prismatic, and pouch. All three types also face different challenges in terms of manufacturability, performance, durability, safety, quality testing, and failure analysis.

Cell Types

Quality Challenges

- Three different battery cell types present numerous distinct challenges during production and assembly
- Malfunctions may be caused by issues relating to overhang, weld tabs, and electrode defects

ZEISS Solutions

- Identify metal particles, delamination, winding, electrode burn marks, and more using ZEISS X-ray solutions
- Defect inspection on module assembly, dimensional metrology on battery housing for all cell types using ZEISS X-ray solutions

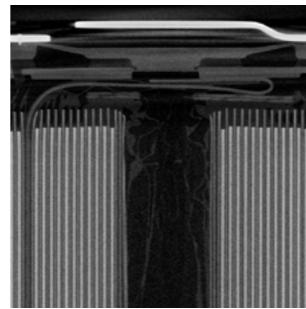

Cell Inspection

Quality Challenges

- Metal contamination generated during cell manufacturing must be detected as it can cause a short circuit
- Avoid safety hazards and waste, check electrode alignment and position, identify internal defects
- Need to handle high cell production speeds via quick, high-resolution inspection cycles

ZEISS Solutions

- Automatic detection of metal particles with ZEISS Automated Defect Detection (ZADD) and inspection with ZEISS industrial CT systems
- Insufficient overhang, damaged electrodes, and weld quality issues inspected at high resolution with ZEISS 2D and 3D X-ray solutions
- 100% inline automated defect detection with ZEISS BOSELLO X-ray solutions



Module Assembly

Quality Challenges

- The size and density of the module demands the use of high-power systems
- Final quality check must detect typical defects including metal contamination, housing welding inspection, and glue area inspection

ZEISS Solutions

- Handle large, heavy, and dense battery modules with the high-powered ZEISS VoluMax 9 titan
- Perform fully intact high-penetration inspection of the module

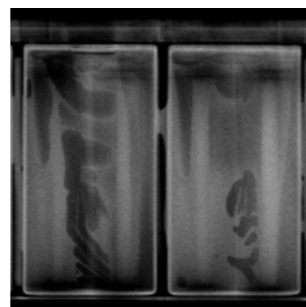

Quality Assurance for Battery Trays

Ensuring proper formation and integration

As a battery receptacle fully integrated into the body of an electric vehicle, the battery tray must be mechanically stable and fit seamlessly into its surroundings. Featuring a complex aluminum weld design, it houses all battery cells, connectors, control units, and the battery packs that contain numerous battery modules. The integrity and structure of the battery tray must be inspected at multiple intervals during production, with methods such as full-field inspection ensuring quality and safety.

Joining Process Control

Quality Challenges

- Long measurement/inspection cycles, plus many geometric elements and weld joints
- Inline solution needed for production as tray often requires 100% monitoring

ZEISS Solutions

- ZEISS Inline Solutions: correlation-free, traceable measurement and inspection data
- Fast feature measurement: ZEISS AICell trace
- Real-time process monitoring of all complex characteristics



Milling and Drilling Process Control

Quality Challenges

- Torsion and bending of the battery tray due to thermal expansion of the battery pack when charging and driving
- Measurement of numerous dimensional characteristics via random sampling or complete automated end-of-line inspection

ZEISS Solutions

- Horizontal arm machine: multisensor measurement of large number of features with quick inspection cycles
- Quickly extract feature data using ZEISS non-contact optical laser scanners
- Access challenging optical features such as undercuts with ZEISS tactile probe systems



Full-Field Inspection

Quality Challenges

- Evaluation of the complete tray surface affects dimensional accuracy of the entire vehicle body
- Correct positioning of flexible cables and connectors is needed to ensure flawless assembly of the battery tray and cover
- Battery modules must be correctly fitted to battery compartments for safe use

ZEISS Solutions

- Automated 3D full-field tray measurement with ZEISS ScanBox for fully geometric digital twin
- Time-saving digital assembly with ZEISS INSPECT software, including all connecting components and their alignments
- ZEISS solutions provide clarity on thermal battery module deformation after cycle tests
- Ensuring the correct placement of the individual battery modules with repeatability and high accuracy using ZEISS ARAMIS



Critical Functions

Quality Challenges

- Final safety check and certification of the complete battery tray
- Serious safety issues if thermal expansion causes torsion and bending on the tray

ZEISS Solutions

- Use tactile and optical sensors on a single ZEISS CMM with a large measurement volume
- Inline/atline result comparison/correlation: ZEISS CMM, ZEISS CALYPSO, ZEISS PiWeb

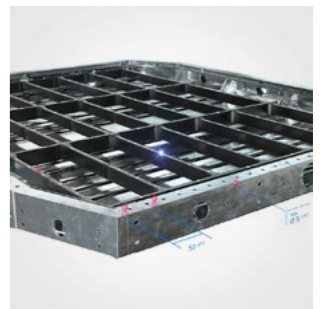

Structure Analysis

Quality Challenges

- Trays commonly manufactured via welding/casting: risk of critical hidden defects and inner structure defects
- To identify rejects, operators must be able to look inside the material and determine the defect size and position

ZEISS Solutions

- Detect, locate, classify, and rate internal defects with ZEISS 2D and 3D X-ray solutions
- Detailed digitization of complex parts using systems such as ZEISS METROTOM
- Revealing the unseen is key to identifying defects and ensuring reliability



Solutions at Every Step of Production

Blue Line for batteries

The Blue Line concept from ZEISS makes quality assurance simple. It identifies quality challenges and dedicated ZEISS solutions at every step in the production process, with each of these steps clearly defined as a Quality Gate. In the field of NEV batteries, the Blue Line features Quality Gates that range from the initial development of battery materials to the final inspection of the assembled battery module – plus everything in between.

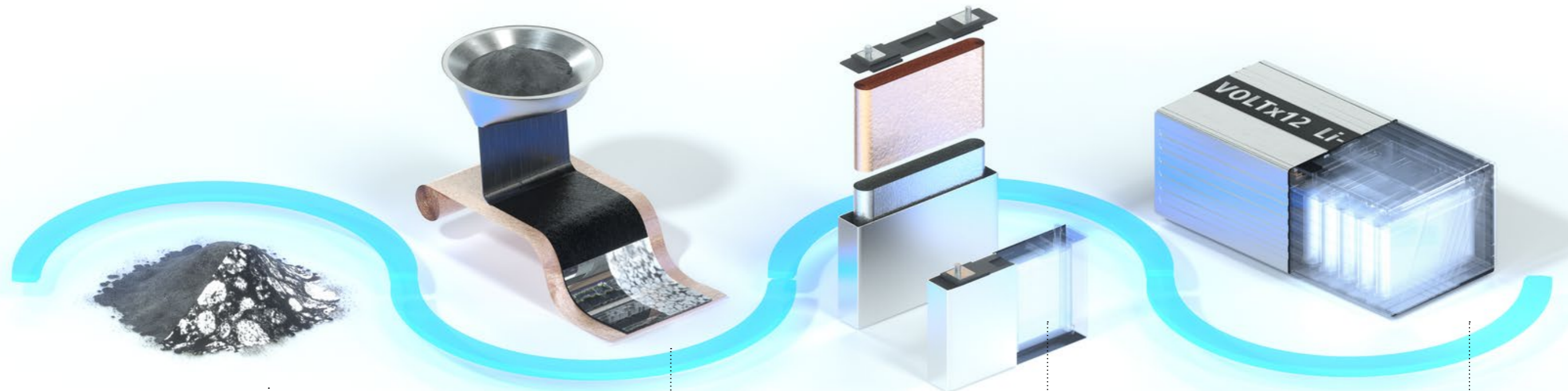

Material Development

- ZEISS Scanning Electron Microscopes (SEM)
- ZEISS ZEN core Software

Structure Development

- ZEISS GeminiSEM
- ZEISS Versa
- ZEISS ZEN core Software

Raw Material Processing

- ZEISS GeminiSEM
- ZEISS ZEN core Software
- ZEISS ARAMIS

Electrode Production

- ZEISS Technical Cleanliness Solutions
- ZEISS Light Microscopes
- ZEISS ZEN core Software

Cell Production

- ZEISS X-Ray Solutions
- ZEISS INSPECT X-Ray
- ZEISS DeepVision AI tool

Module Assembly

- ZEISS X-Ray Solutions
- ZEISS INSPECT X-Ray

XRM: The X-Factor for Submicron Imaging

Expert insight from **Dr. Herminso Villarraga-Gómez**,
X-Ray Quality Solutions Manager, ZEISS Industrial Quality Solutions



Computed tomography (CT) and X-ray microscopy offer nondestructive inspection of highly complex NEV components such as batteries. 3D X-ray microscopy (XRM) solutions like the ZEISS Versa family duly combine the benefits of both technologies to support submicron imaging of particularly small details.

“3D X-ray microscopy excels at nondestructive submicron imaging.”

XRM uses a multi-detector system for two-stage magnification. Following the geometric magnification performed by CT and XRM systems alike, XRM uniquely adds optical magnification via adjustable lenses for remarkable clarity. This optical stage delivers the submicron precision that is beyond the scope of traditional CT scanning.

The dual approach is what allows operators to scan the full field of view before zooming in for a much more detailed look. “With its high contrast and outstanding resolution, 3D X-ray microscopy provides truly in-depth insight into the microstructure,” says Dr. Herminso Villarraga-Gómez, X-Ray Quality Solutions Manager at ZEISS Industrial Quality Solutions.

As Dr. Villarraga-Gómez explains, not only can XRM handle different battery types and densities, “it is ideal for analyzing a wide variety of potential quality issues that demand crystal-clear detail.” These include aging, calendaring pressure, and cracks, all of which must be closely monitored in safety-critical NEV components.

The submicron precision of XRM is especially suitable for materials analysis tasks, such as checking the anode and cathode structure. Systems from the ZEISS Versa family can additionally be combined with ZEISS Scout-and-Scan software, enabling further in-depth findings about the interior of the battery via 3D reconstruction.

Two-stage magnification is the X-factor that helps XRM perform nondestructive scans in the submicron range. So while CT is generally associated with macroscale features and larger components ranging up to entire modules, XRM offers precision handling of individual cells and smaller samples as well as detailed materials analysis. “3D X-ray microscopy excels at nondestructive submicron imaging,” concludes Dr. Villarraga-Gómez.

ZEISS
Versa

CT: Boosting Quality and Safety at Every Stage

Expert insight from **Dr. Dana Begun**,
Application Engineer – CT Specialist, ZEISS Industrial Quality Solutions

The NEV sector is characterized by safety-critical parts with a high cost of failure. Any issues affecting these components can have dangerous and expensive consequences. Computed tomography (CT) supports robust nondestructive analyses that are key to quality and safety checks across EV manufacturing processes.

“Computed tomography powers every stage of NEV battery manufacturing.”

Unlike destructive tear-down methods, CT has the penetration strength to see stunning detail while leaving the workpiece itself fully intact. When it comes to NEV batteries, for example, it is capable of imaging cylindrical, pouch, and prismatic cells as well as scanning whole battery modules. The flexible performance of CT is increasingly vital for nondestructive evaluation of a wide range of NEV components.

In addition to inspecting a variety of faults such as insufficient electrode overhang and foreign object debris, it also facilitates failure analysis by visualizing features like overcharge safety devices (OSDs) and fuses. By detecting issues as early as possible, CT boosts safety, reduces waste, and provides important findings for further optimization.

“CT is greatly defined by its potential for multi-scale deployment,” notes Dr. Dana Begun, Application Engineer – CT Specialist at ZEISS Industrial Quality Solutions. “From atline production to the quality assurance lab and from failure analysis to R&D, it powers every stage of NEV battery manufacturing.”

As Dr. Begun says, CT delivers numerous benefits. When implemented in inline and atline settings, CT can provide consistent, high-throughput imaging at multiple stages of assembly. CT is invaluable for R&D and design optimization, both of which require high image resolution and quality. For example, the battery aging process can be monitored throughout longitudinal cycling experiments. CT performance can also be adjusted to meet specific needs.

In this way, CT brings nondestructive insight to every stage of the NEV battery manufacturing process – even for entire module assemblies. Its versatility enables operators to save time, energy, and money while ensuring the necessary high level of quality throughout. “CT supports safety and innovation on the NEV battery market,” adds Dr. Begun.

ZEISS INSPECT
X-Ray Software

ZEISS
METROTOM

ZEISS
VoluMax

E-Motor Quality Management

Highest accuracy for automated processes

Electric motors are the true powerhouses in electric vehicles, combining high speed and enormous torque while being light and compact. Many of their components are produced in automated processes and must interlock precisely for perfect interaction with minimal wear. Checks must be performed at every stage of production to ensure proper positioning, accurate dimensions, and high-quality weld seams.

These precision assemblies require micrometer-level accuracy and a range of technologies including automated and contact-free solutions. From inspecting the hairpins and sheet stacks to measuring the rotors and shafts, you can do it all with the ZEISS portfolio.

→ Find the perfect product for your application: [page 54](#)

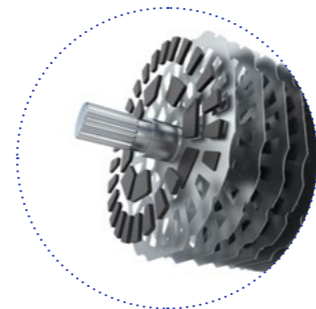

Rotors and Shafts
Inspection of shape
and location
[Page 25](#) →

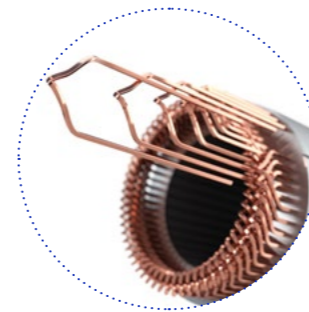

Hairpins
Inspection of dimension
and position
[Page 22](#) →

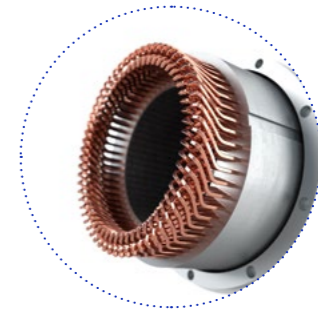

Stators
Defect inspection
and digitization
[Page 26/28](#) →

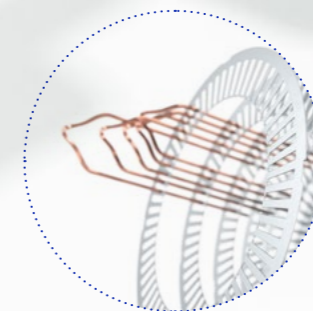

Sheet Stacks
Inspection of geometry
and surface
[Page 24](#) →

Quality Assurance for Hairpins

Geometrical inspection and non-contact digitization

Hairpins consist of a bent rectangular copper wire and are coated with an insulating layer. Since they are highly susceptible to deformation and their ends are difficult to weld, it is necessary to inspect the dimensions and positions of hairpins during the stator assembly process. These sensitive components must be examined using contact-free techniques that can handle a wide range of lengths, angles, and cross-sections within the individual hairpin geometries.

Geometrical Inspection and Coating Quality

Quality Challenges

- Each hairpin features a flexible structure and a sensitive insulating lacquer coating
- Difficult to geometrically inspect individual dimensions when using tactile techniques

ZEISS Solutions

- Accurate measurement of hairpin shape and lacquer thickness with ZEISS CMM plus confocal light sensor or laser triangulation optical sensor
- Handle structural properties of hairpins via non-contact measurement with optical probes on ZEISS CMM



Non-Contact Digitization

Quality Challenges

- Extremely sensitive wires in hairpins require a non-contact, digital approach
- Full-field 3D data is essential for verifying hairpin geometry and position

ZEISS Solutions

- One-click capture of free-form 3D coordinates using 3D OMM ZEISS ScanBox for eMotors
- Fully automated non-contact digitization of sensitive structures
- Pretreatment-free laser triangulation for fast full-field digitization via optical sensor

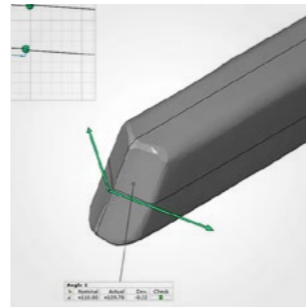

Bending Design Quality

Quality Challenges

- Hairpin design is developed in multiple loops via bending parameter configuration
- Evaluation of finished hairpins in relation to master pin requires scanning and production of CAD models

ZEISS Solutions

- Fringe projection and laser triangulation generate high-resolution point clouds
- Reverse engineering quickly turns these into high-quality CAD models

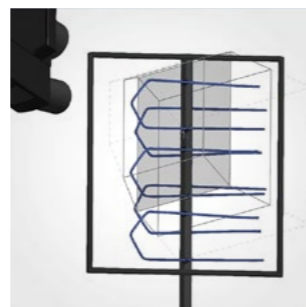

Quality Assurance for Sheet Stacks

Sheet inspection and stack positioning

Sheet stacks comprise numerous 2D sheets, each punched or laser cut from electrical steel sheets and with a thickness of less than 1 mm. Key quality aspects include the cross-section slot geometry for the hairpins, the permanent magnet slots, and the inner and outer diameter of the sheet stack assembly. Since tolerances are in the micrometer range, the sheets must be flat and burr-free to ensure proper e-motor performance.

Geometrical Inspection

Quality Challenges

- Assessment of 2D geometry, flatness, and absence of burrs on numerous sheets to ensure ideal stack assembly
- QA with micrometer-level precision for proper fit and electric motor performance

ZEISS Solutions

- Automated pallet inspection combining tactile and optical probes on multisensor ZEISS CMMs
- Promotes increased machine utilization and reduced inspection cycle times
- Quick and effective internal defect detection with ZEISS X-ray solutions

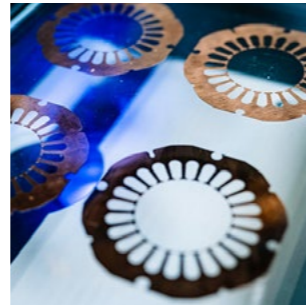

Assembly Quality

Quality Challenges

- Sheet positioning for laser welding has a major impact on the geometry of the stator and rotor slots
- It is vital to perform post-welding inspection of slot dimensions and positions, plus stack height and diameter

ZEISS Solutions

- Even more thorough inspection using ZEISS CMMs combined with 2D cameras and white light confocal sensors
- Fully automated high-speed inspection of component pallets

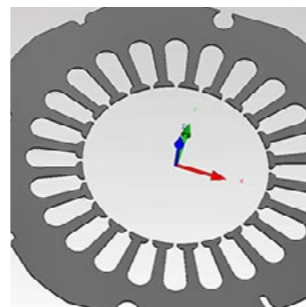

Quality Assurance for Rotors and Shafts

Dimensional measurement and porosity analysis

The rotor is comprised of the shaft, the sheet stack, and built-in permanent magnets. Due to the high performance and speed of the e-motor, the rotor must meet very tight shape and location tolerances that require inspection. The air gap between the rotor and the stator bore is one of the main parameters that define the performance and efficiency of the e-motor. It is also critical with respect to safety and reliability.

Rotor Dimension Measurement

Quality Challenges

- Deflections caused by the rotor's magnetic field can impair results
- Long and heavy stylus systems are therefore essential for measuring dimensional features with the tightest tolerances

ZEISS Solutions

- These requirements are ideally met by ZEISS CMMs with active scanning technology
- Long stylus extensions keep the probe away from strong magnetic field, ensuring stable and accurate results at every rotor position



Shape and Contour Analysis

Quality Challenges

- Shafts require swift quality inspection due to fast rotation speeds
- This is particularly relevant with regard to shape and position tolerances, which continue to narrow as shaft geometries change

ZEISS Solutions

- Meet strict tolerances, reduce throughput times, and increase predictability with a ZEISS CMM
- This can be combined with a highly accurate rotary table and diamond stylus kit to deliver reliable results for shafts of all sizes



Porosity Analysis

Quality Challenges

- Rotors must now offer much greater strength and stability in order to handle increasing e-motor speeds
- To prevent rotor breakage during operation, a specific porosity level must not be exceeded

ZEISS Solutions

- Determine the size and number of pores in the rotor's short-circuit ring with ZEISS X-ray solutions
- Analyze and classify the reconstructed 3D data via porosity analysis using ZEISS INSPECT X-ray software

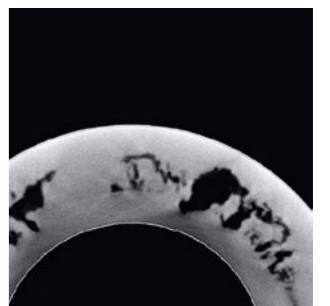

Quality Assurance for Stators

Defect inspection and 3D measurement

Among all components in the latest generation of electric motors, the stator offers the greatest potential for improving e-motor performance, power, and efficiency. Given the use of new raw materials and innovative manufacturing technologies, it is essential to implement quality assurance across all stator production steps in order to guarantee the safety, reliability, and performance of e-motors.

Insulation Paper and Hairpin Position

Quality Challenges

- Since the insulation paper and the highly flexible copper hairpins need to be inserted into sheet stack slots during stator assembly, accurate dimensional inspection is necessary
- Position and length of the insulation paper between the hairpins and stator core must be inspected to reduce the risk of a short-circuit

Quality Challenges

- The power supply connection points are welded
- Inspection of hairpin end positions before and after welding is critical for e-motor safety, reliability, and performance

ZEISS Solutions

- Insulation paper positioning with optical 3D scanning and ZEISS CMMs
- Determine position of hairpin weld tips using ZEISS PRISMO with tactile styli
- Automated full-surface scanning and digitization of individual hairpins or complete stators with ZEISS ScanBox for eMotors
- Optimum process control and merging of measurement results via ZEISS software

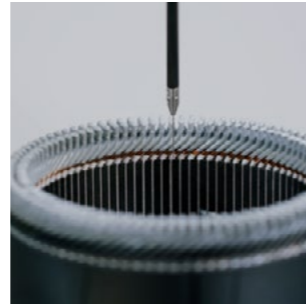

ZEISS Solutions

- ZEISS ScanBox for eMotors uses 3D coordinates distributed across a wide area to generate a full geometrical digital twin in the software
- This enables quick and reproducible identification of deviations and defects in the component geometry by means of comparison with the CAD model
- Automatic trend analysis with the ZEISS Quality Software enables the early identification of deviations from the ideal model

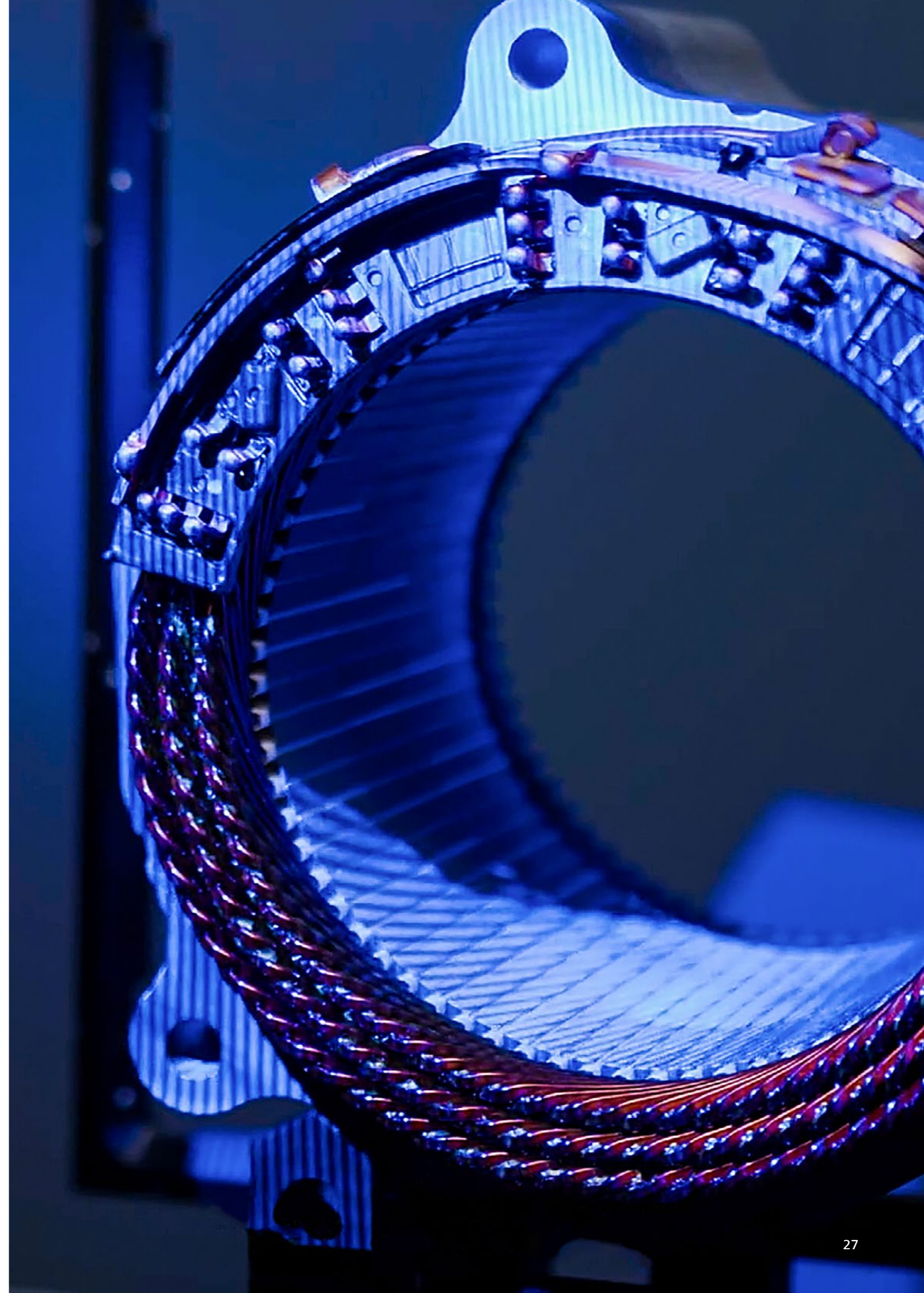
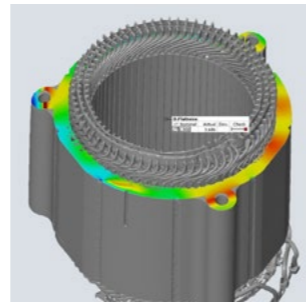

Quality Assurance for Stators

Defect inspection and 3D measurement

To ensure the safety, reliability, and performance of the e-motor, quality assurance must be maintained throughout all stator production stages. Nondestructive inspection of all weld seams is needed to identify defects that can cause a loss of e-motor performance.

Weld Seam Inspection

Quality Challenges

- Lacquer residue may be generated during the welding process and weld parameters may fluctuate
- The resulting weld seam porosity may impair e-motor performance or cause total failure
- Nondestructive defect inspection is a critical requirement for all weld seams

ZEISS Solutions

- Detection, localization, and classification of weld seam pores and defects with ZEISS industrial CT solutions
- Ensures nondestructive quality assurance and monitoring of welding
- ZEISS Automated Defect Detection (ZADD) software for detection based on AI (artificial intelligence)

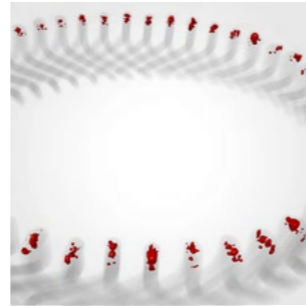

Installation Space Analysis

Quality Challenges

- For electric motor assembly, the external stator dimensions must not exceed the installation space in the e-motor housing
- Complex geometries and mixed materials in stator make it harder to perform QA on overall component

ZEISS Solutions

- Automated switching between sensors via ZEISS CMMs with ZEISS mass technology
- Combination of laser triangulation probes and tactile stylus systems enables full QA of pre-assembled stator
- Automated inspection of larger quantities: ZEISS Integration Series

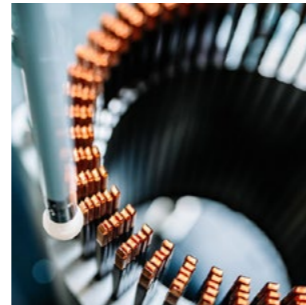

Solutions at Every Step of Production

Blue Line for electric motors

The Blue Line concept from ZEISS makes quality assurance simple. It identifies quality challenges and dedicated ZEISS solutions at every step in the production process, with each of these steps clearly defined as a Quality Gate. In the field of electric motors, the Blue Line features Quality Gates that range from the geometrical inspection of hairpins to the analysis of stator installation dimensions – plus everything in between.



Full Coverage of All E-Motor Applications with ZEISS

Expert insight from **Kenny Zheng**,
NEV Application Manager at ZEISS Industrial Quality Solutions

Rapid development in the dynamic field of electric motors means that manufacturers must handle an ever-expanding range of applications. In terms of stators, this involves tasks such as dimensional metrology, defect inspection, and component digitization. With ZEISS uniquely offering full coverage of all corresponding technologies, let us explore how its one-stop portfolio addresses every challenge manufacturers may face.

“The wide-ranging ZEISS portfolio is always up to speed in this swiftly evolving field.”

During stator assembly, manufacturers must perform precision dimensioning of individual hairpins and the available installation space. “ZEISS coordinate measuring machines enhance measurement productivity through their efficient and flexible performance,” says Kenny Zheng, NEV Application Manager at ZEISS Industrial Quality Solutions.

ZEISS PRISMO and ZEISS CONTURA are two such CMMs that can be combined with the ZEISS LineScan optical sensor to determine the geometry of hairpins. The results can then be analyzed and visualized in detail using the software ZEISS Quality Software to ensure high-quality production and a perfect fit. This seamless interaction between hardware and software is another hallmark of the holistic ZEISS portfolio.

When it comes to performing defect inspection on stators, the nondestructive CT system ZEISS VoluMax 9 titan offers truly in-depth results thanks to its 450 kV performance. With its high penetration power drastically reducing cycle time during this task, the ZEISS VoluMax 9 titan contributes to greater efficiency.

Crucially, notes Zheng, “this speed does not come at the expense of quality.” Scans generated by the ZEISS VoluMax 9 titan can be analyzed with ZEISS INSPECT X-Ray software for precision tasks such as weld seam inspection. In performing defect detection via trained AI models, the ZADD Segmentation app reliably and quickly detects small and fuzzy defects in components, even in the case of poor image quality. These solutions from the ZEISS portfolio combine to boost efficiency through increased CT scan speed, accurate checks, and far shorter cycle times.

“Efficiency is also behind the drive toward digitization and fully automated inspection,” notes Zheng. First, the ZEISS ScanBox for eMotors swiftly captures precise 3D measurement data and performs automated full-surface stator scans with the integrated ZEISS ATOS Q 3D sensor. To extract maximum value from this data, it is then visualized and analyzed using the inspection software available in the ZEISS Quality Suite. This software offers a host of functions including the generation of a full geometrical digital twin, which enables the component to be compared with its 3D model for quick

and reproducible defect identification. Zheng also highlights the importance of trend analysis “for early detection of deviations to ensure the production process always runs smoothly.”

From stators to sheet stacks and beyond, only the ZEISS portfolio caters to all electric motor applications. Manufacturers benefit from faster cycle times, more efficient processes, and seamless interaction between hardware and software. For Zheng, “the wide-ranging ZEISS portfolio is always up to speed in this swiftly evolving field.”



ZEISS Quality Suite

ZEISS VoluMax

ZEISS CMMs

Fuel Cell System Quality Management

Precision inspection of individual components

Comprising a bipolar plate (BPP) and a membrane electrode assembly (MEA), each fuel cell in the stack is connected in series and therefore crucial to overall system quality. To ensure compliance with stringent demands, they must be inspected in relation to their coating, potential surface defects including contamination, and weld seam.

ZEISS solutions help meet quality requirements throughout the entire value chain for fuel cell system production. Hardware and software work in tandem to generate clear component-related reports.

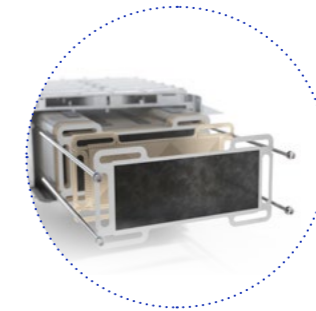

Membrane Electrode Assembly
Membrane and electrode inspection
[Page 38](#) →

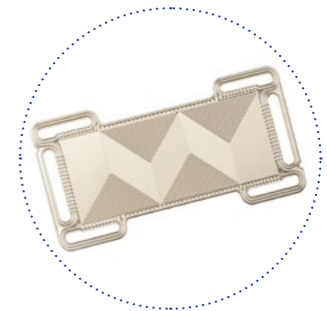

Bipolar Plate
Cell quality inspection
[Page 36](#) →

Peripheral Components
Component quality inspection
[Page 40](#) →

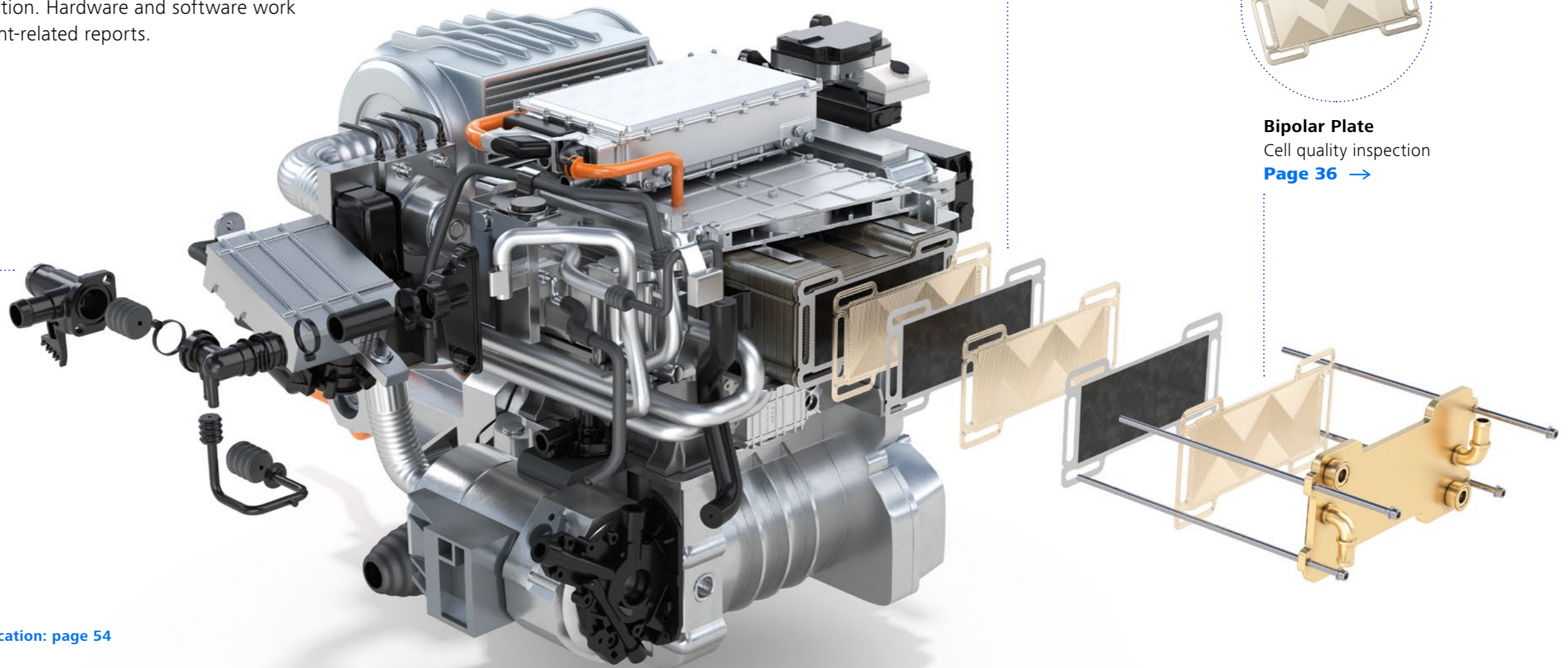

→ Find the perfect product for your application: [page 54](#)

Quality Assurance for Bipolar Plates

Cell quality inspection

There are typically more than one hundred individual fuel cells in a single stack. Efficient generation of electrical energy depends on the guaranteed quality of each cell. The bipolar plate provides mechanical stability, ensuring the flow of media and the electrical connection between adjacent cells in the series.

Microstructure Formation and Single Polar Plate Cutting

Quality Challenges

- Need unhindered flow of gas and coolant through specially designed microstructures
- Degradation such as burr formation must be detected prevent short-circuit
- For stack alignment, ensure dimensional accuracy of outer contours, recesses, and geometric elements

ZEISS Solutions

- Chromatic white light measurement using the ZEISS DotScan sensor on a ZEISS CMM with rotating probe head
- 3D polished micrograph imaging with ZEISS Axio Imager 2 light microscope
- Ideal preparation for plate welding and stacking with optical contour measurement using ZEISS O-INSPECT



Coating of Polar Plates

Quality Challenges

- Polar plate coating is essential to corrosion protection and must be analyzed for cracks, bubbles, and other defects
- The thin steel layer on a BPP presents risk of surface defects that can impair efficiency or cause total failure

ZEISS Solutions

- Optical inspection for coating layer thickness measurement: ZEISS Axio Imager
- Automated high-resolution imaging and evaluation with multisensor solutions
- Nanometer-scale quantification of roughness/topography

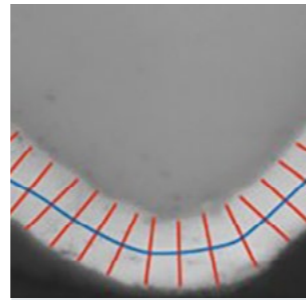

Welding into Bipolar Plates

Quality Challenges

- Lateral alignment of single plates and total height are essential to functionality
- Ensure unhindered gas and coolant flow, compliance with cell stacking tolerances, and fuel cell efficiency
- Bipolar plate is formed from two welded single plates: weld seam is crucial to conductivity and sealing performance

ZEISS Solutions

- Capture the 3D structure on both sides with the ZEISS DotScan sensor on a ZEISS CMM
- Nondestructive 3D scanning for 3D geometry evaluation incl. lateral alignment and deviations in thickness
- Detailed and accurate high-resolution 3D data from ZEISS METROTOM 1500 CT or ZEISS Versa X-ray microscope

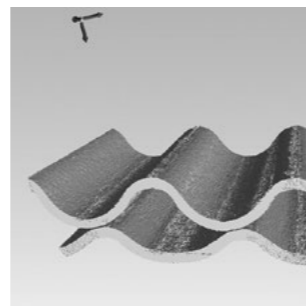

Quality Assurance for Membrane Electrode Assemblies

Membrane and electrode inspection

A chemical reaction in the membrane electrode assembly (MEA) is the key to electrical energy in the stack. Two electrodes are positioned on each side of the MEA and house the relevant catalysts. These electrodes are applied to both sides of the membrane (CCM) or to the respective gas diffusion layer (CCL).

MEA Stacking

Quality Challenges

- Avoid contamination to ensure fuel cell function, quality, and service life
- Ensure consistent MEA layers and properties by testing sample sections
- 3D volume analysis for process development and defect understanding
- Fully inspect all MEAs for coating defects to avoid performance drop

ZEISS Solutions

- Particle detection with with ZEISS Axio Zoom V.16 microscope, analyzed with electron microscopy, processed with ZEISS software
- Capture the size, shape, quantity, composition, origin, and metallic content of particles > 5 μm
- Analyze layer continuity and thickness with the ZEISS Axio Imager
- Nondestructive 3D volume acquisition with the ZEISS 620 Versa X-ray microscope and its two-stage magnification

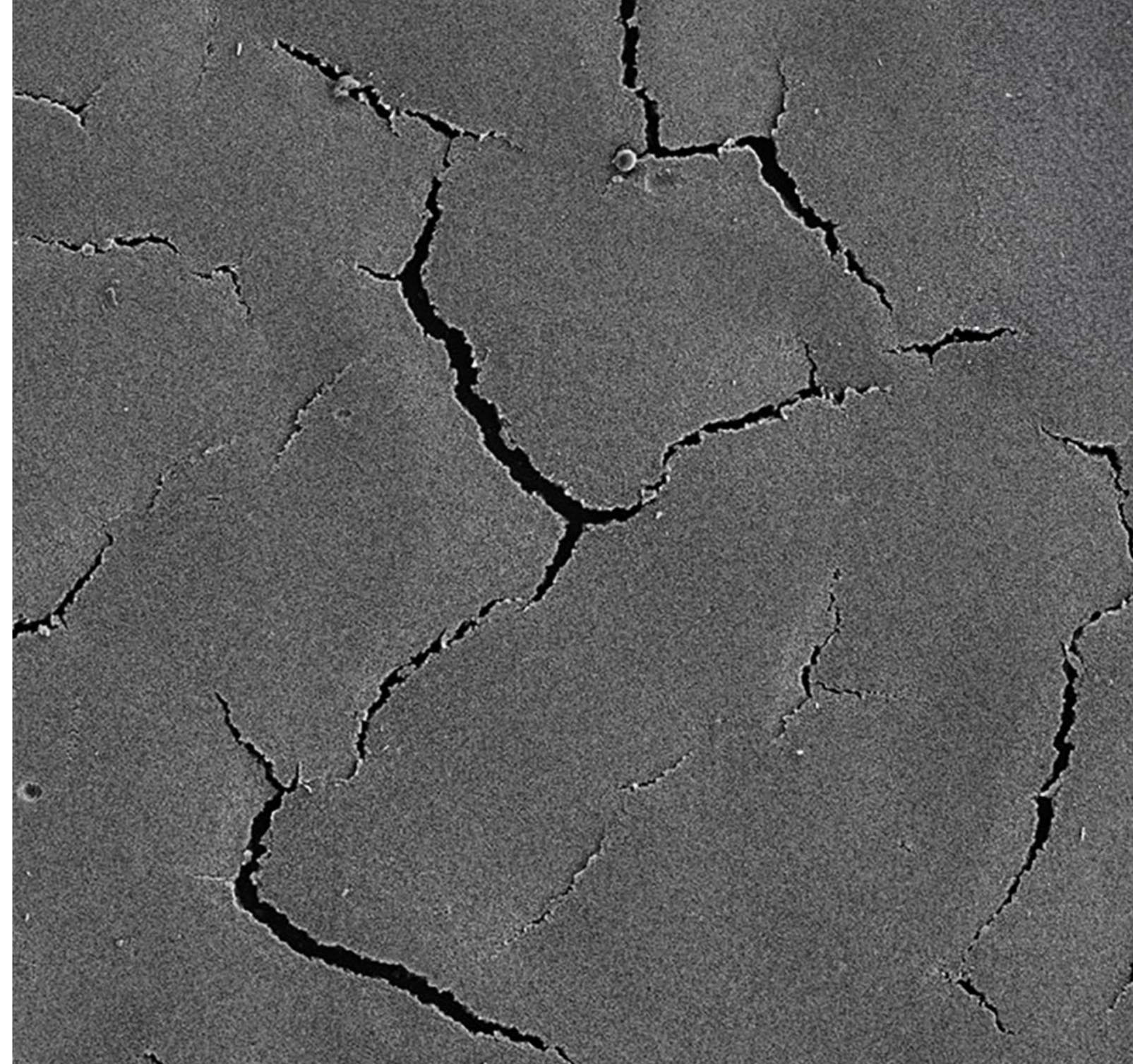
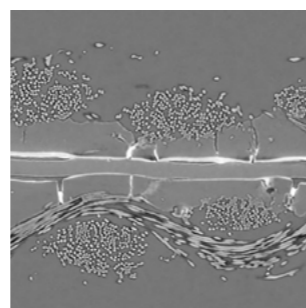

Final Fuel Cell Stacking

Quality Challenges

- Monitor stacked fuel cells (BPPs and MEAs) to ensure consistency of fuel cell stack layers and their properties
- Enhance process development and understanding of defects via 3D volume analysis

ZEISS Solutions

- Analyze small samples using X-ray technology to ensure layer continuity
- Analyze stack geometries and alignment with the non-contact confocal white light sensor ZEISS DotScan on a ZEISS CMM

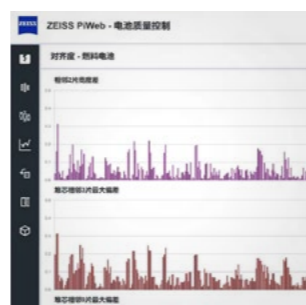

Coating and Cutting of Layers

Quality Challenges

- Ultra-thin electrode layer coating must be analyzed for cracks, bubbles, particle contamination, and inhomogeneity
- Position and orientation of individual layers influences energy conversion efficiency in the fuel cell
- 2D geometry analysis must be performed on single layers to establish accurate dimensions of edges and recesses
- Need entirely defect-free MEA to develop full performance

ZEISS Solutions

- Crack analysis using the ZEISS Axio Imager light microscope or scanning electron microscopes such as ZEISS GeminiSEM
- Determine recess size and position plus coating margin based on reference edge
- Easy measurement of these characteristics with optical edge detection technology and integrated backlight in ZEISS O-INSPECT
- Dimensional measurement with multisensor CMM

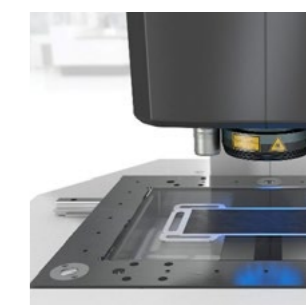

Quality Assurance for Peripheral Components

Component quality inspection

Many components besides the fuel cell stack are relevant to the fuel cell system. Hydrogen for the chemical reaction is transported via a piping system. Oxygen is obtained from the ambient air and processed using pumps, filters, water separators, and more. The efficiency of a fuel cell system is dependent on the quality of its peripheral components.

Stack Assembly

Quality Challenges

- Individual BPP and MEA units are tightly packed to construct a dense cell stack
- Structural geometries are crucial for diffusing pressure within stack during operation

ZEISS Solutions

- Detect defects, pores, or inclusions in cast structure with ZEISS CT to ensure component quality
- Measure and evaluate machined connection surface with ZEISS tactile and optical coordinate measuring technology

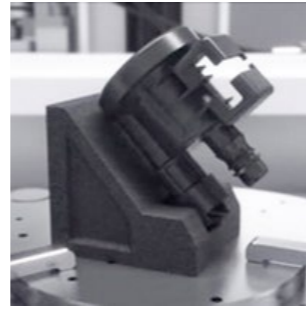

Media-Carrying Components

Quality Challenges

- Complex pipe systems supply hydrogen and oxygen to the fuel cell stack and also remove cooling water
- Component geometry and material properties are very important for functionality and durability of entire system

ZEISS Solutions

- Capture 3D data from injection-molded components to ensure ideal properties
- This 3D data is used to detect internal defects using ZEISS software
- Can view and measure all thicknesses and also calculate a complete nominal-actual comparison with CAD model

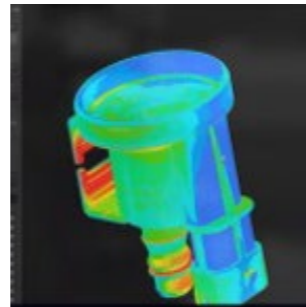

Compressors and Pumps

Quality Challenges

- Compressors, pumps, and water separators help maintain proper conditions for hydrogen and air
- This is crucial for properly completing chemical reactions and the transport process

ZEISS Solutions

- Certify the dimensions regarding size, shape, and position using optical and tactile sensors on a ZEISS CMM
- This can be performed for sealing surfaces, bearing seats, and other geometric elements

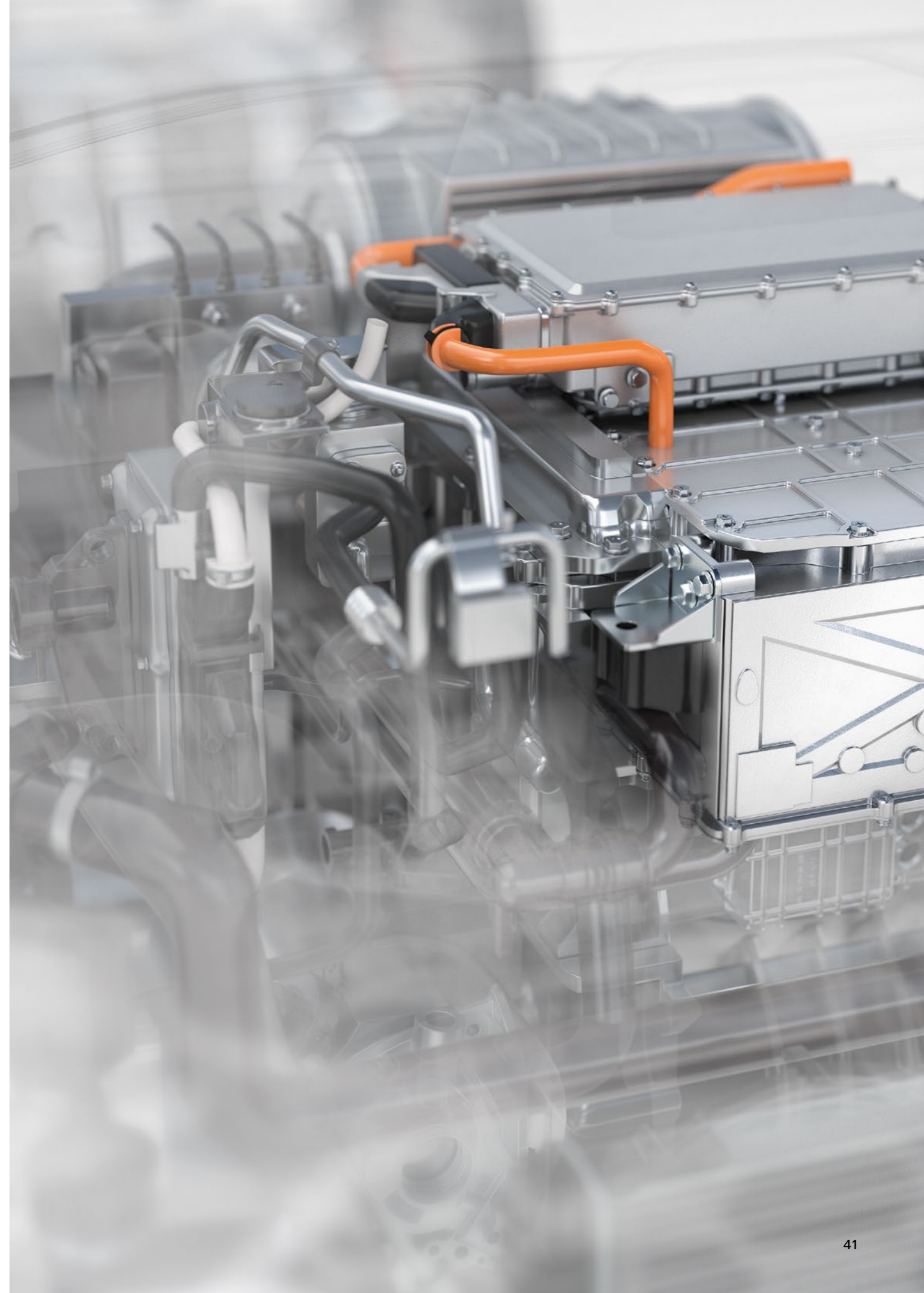
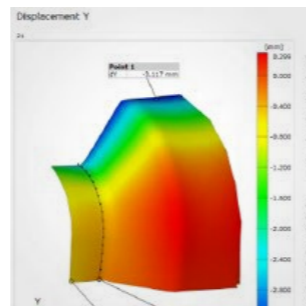

Solutions at Every Step of Production

Blue Line for fuel cell systems

The Blue Line concept from ZEISS makes quality assurance simple. It identifies quality challenges and dedicated ZEISS solutions at every step in the production process, with each of these steps clearly defined as a Quality Gate. In the field of fuel cell systems, the Blue Line features Quality Gates that range from the formation of the microstructure to the final stacking of the fuel cell – plus everything in between.

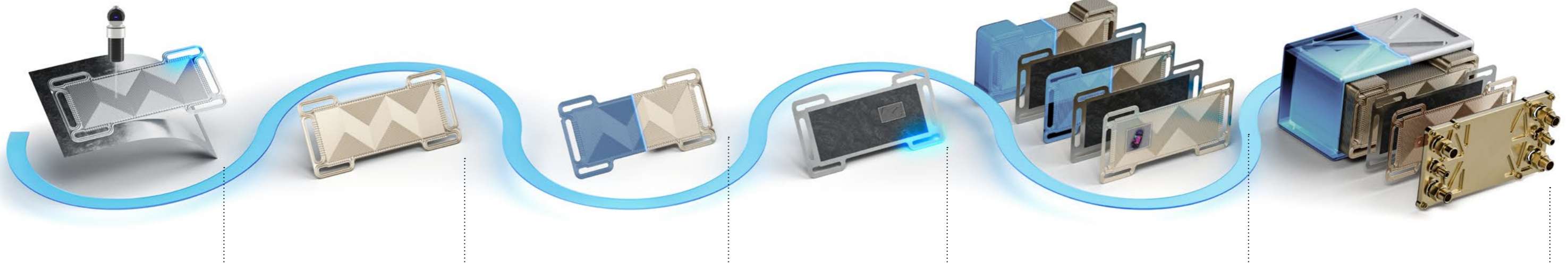

Microstructure Formation and Single Polar Plate Cutting

- ZEISS DotScan
- ZEISS Axio Imager 2
- ZEISS O-INSPECT

Coating of Polar Plates

- ZEISS Axio Imager 2
- ZEISS O-INSPECT duo

Welding into Bipolar Plates

- ZEISS CMMs
- ZEISS METROTOM
- ZEISS DotScan
- ZEISS Versa

Coating and Cutting of Layers

- ZEISS Axio Imager 2
- ZEISS O-INSPECT
- ZEISS GeminiSEM

MEA Stacking

- ZEISS Axio Imager 2
- ZEISS O-INSPECT duo
- ZEISS Axio Zoom V.16
- ZEISS Versa

Final Fuel Cell Stacking

- ZEISS CMMs
- ZEISS X-Ray Solutions
- ZEISS DotScan

Automotive Electronics Quality Management

Precision measurement for reliable power flow

Automotive electronics controls the flow of power between the battery and the electric motor. It forms the energy hub of every battery-electric, hybrid, and fuel cell vehicle. To boost the efficiency and reliability of electronic components, it is essential to check the quality of semiconductors, printed circuit boards (PCBs), and finished modules across different length scales.

ZEISS offers an extensive range of micrometer-range solutions for automotive electronics. These include electron and X-ray microscopes for high-precision non-contact measurements, tactile measurement methods, and automated image processing.

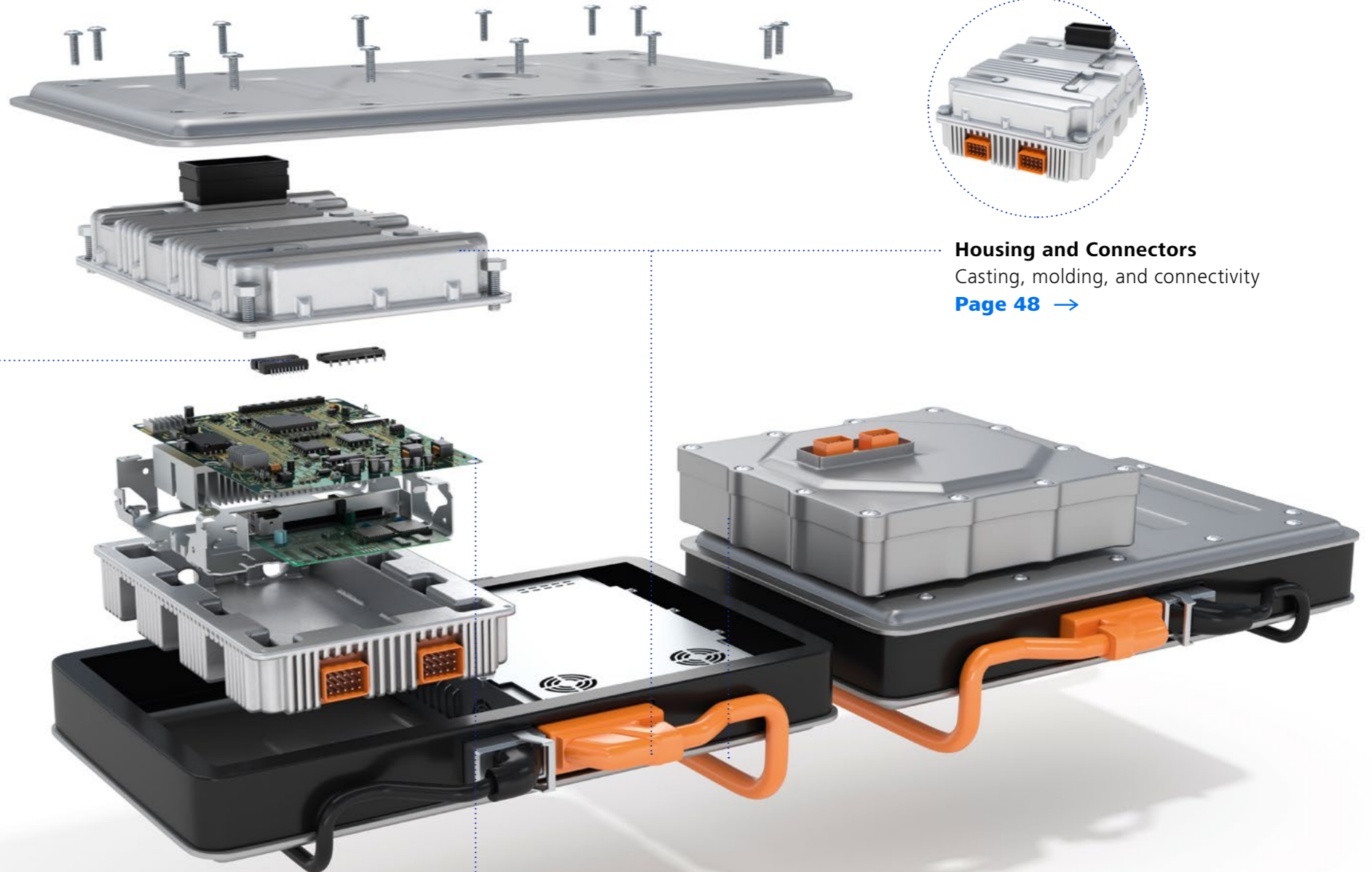

Housing and Connectors
Casting, molding, and connectivity
[Page 48](#) →

Semiconductor
Fault imaging and power delivery
[Page 46](#) →



Printed Circuit Board
Quality control and failure analysis
[Page 47](#) →

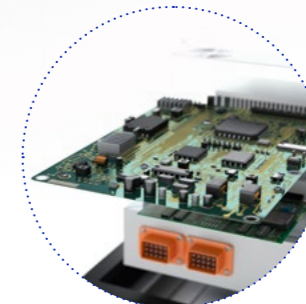

→ [Find the perfect product for your application: page 54](#)

Quality Assurance for Semiconductor

Fault imaging and power delivery

The NEV driving experience is governed by an increasingly compact setup integrated into the electronic control system. Improvements in processing power and efficiency enable vehicles to manage external sensor inputs, e-motor feedback, and remote telemetry: These augment driver inputs to ensure a safe, efficient, and enjoyable driving experience. Quality assurance for semiconductors must keep pace with rapid evolution and expanding requirements.

Motor Control and Gate Drivers

Quality Challenges

- Semiconductor integrated circuit design, manufacture, and quality control requires a number of microscope-based workflows
- Need for detailed fault identification as well as high-contrast, high-resolution imaging

ZEISS Solutions

- Unique combination of material contrast, resolution, and beam stability with ZEISS GeminiSEM technology
- Identify manufacturing irregularities in semiconductor packages using ZEISS X-ray microscopy
- Nondestructive identification of failure modes such as delamination and cracks in electrical contacts

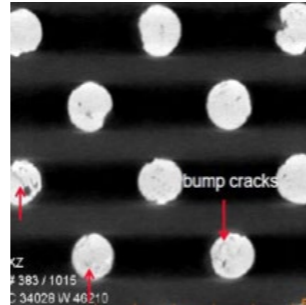

Automotive Electronics

Quality Challenges

- High-power switching devices are core technologies for delivering controlled power from battery to e-motor
- Examples: insulated-gate bipolar transistor (IGBT), power metal-oxide-semiconductor field-effect transistor (MOSFET)
- Their properties must be mapped to aid design and analysis

ZEISS Solutions

- Map electrical and material properties with submicron spatial resolution using ZEISS analytical electron microscopy
- Enables design optimization and improved failure analysis of relevant switching devices
- 3D-testing technology can observe the thermo-mechanical deformation behavior of electrical components such as IGBTs by combining 3D deformation data with thermography data.

Quality Assurance for Printed Circuit Board

Quality control and failure analysis

Quality control and failure analysis of electronic components is essential given their increasing quantities, their ever neater integration, and the presence of harsh environmental factors such as temperature and vibrations. This is especially true in the case of New Energy Vehicles and autonomous driving cars since the electronic devices are highly relevant to safety.

Quality Control and Failure Analysis

Quality Challenges

- Check critical dimensions, surface roughness and topography, and particle contamination
- Increase component production while meeting strict quality requirements via automated inspection

ZEISS Solutions

- X-ray and/or optical technology supports nondestructive printed circuit board (PCB) inspection and failure analysis
- This reveals quality issues and guides the failure analysis workflow in search of the root cause
- Dimension, roughness, topography, and contamination checks handled by high-resolution 2D and 3D imaging, analysis, and optical metrology solutions from ZEISS
- ZEISS ARAMIS can provide information on the deformation behavior of the complete PCB

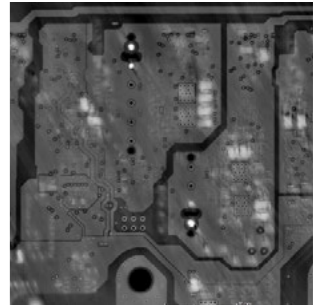

Quality Assurance for Housing and Connectors

Casting, molding, and connectivity

The housing of automotive electronics components is key to the safety and reliability of the entire battery pack. It needs to protect the battery electronics from external influences such as vibrations, humidity, and temperature changes that can each greatly influence failure protection. The connectors and plugs linked to the battery modules must also resist these external influences to ensure safe and easy connectivity every time the vehicle is used.

Casting Inspection and Machined Dimensions

Quality Challenges

- Thin, durable, and lightweight aluminum die-cast walls save material and allow for precise machining
- Sealing surfaces require tight tolerances in terms of flatness and roughness
- Connector plug positioning important for ensuring long-term reliability of electrical contact

ZEISS Solutions

- Meet geometry and roughness requirements with ZEISS CMMs
- These cover all characteristics that are subject to tight tolerances
- Examples include flatness and roughness of seal surfaces, plus position of connector plugs

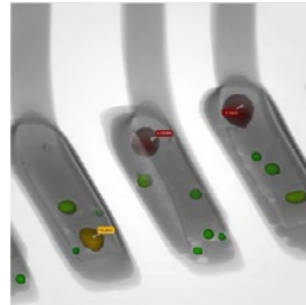

Injection Molding and Connectivity

Quality Challenges

- Injection molding is most commonly used technique, enabling mixed plastics in connector housing
- Large number of connectors in vehicle make this a complex and very fast process
- Position of every pin must be checked to ensure every electrical contact will work

ZEISS Solutions

- Quick measurement, visualization, and analysis of huge number of connectors with ZEISS X-ray solutions
- Overcome challenges such as small pin size and complex geometry for tactile or optical measurement
- Detect defects inside the injection molding areas

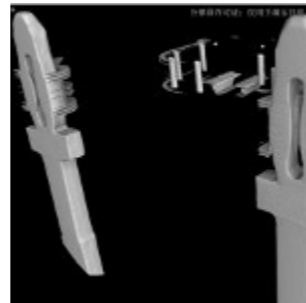

Transmission Quality Management

Detailed inspection for reliable performance

While powertrains in combustion engines have up to nine gears, NEVs simply feature a single- or two-speed transmission. The e-motor and transmission share a housing: This reduces the number of components and the weight, but not the quality requirements. Numerous measuring and inspection steps are needed to ensure top performance, low wear, and quiet operation.

ZEISS offers a full range of sophisticated solutions, such as CT for nondestructive internal defect detection. Its highly accurate CMMs are equipped with tolerance and roughness sensors to ensure proper dimensions and surface quality. They can also be used for conducting precision measurements on many additional components within the transmission.

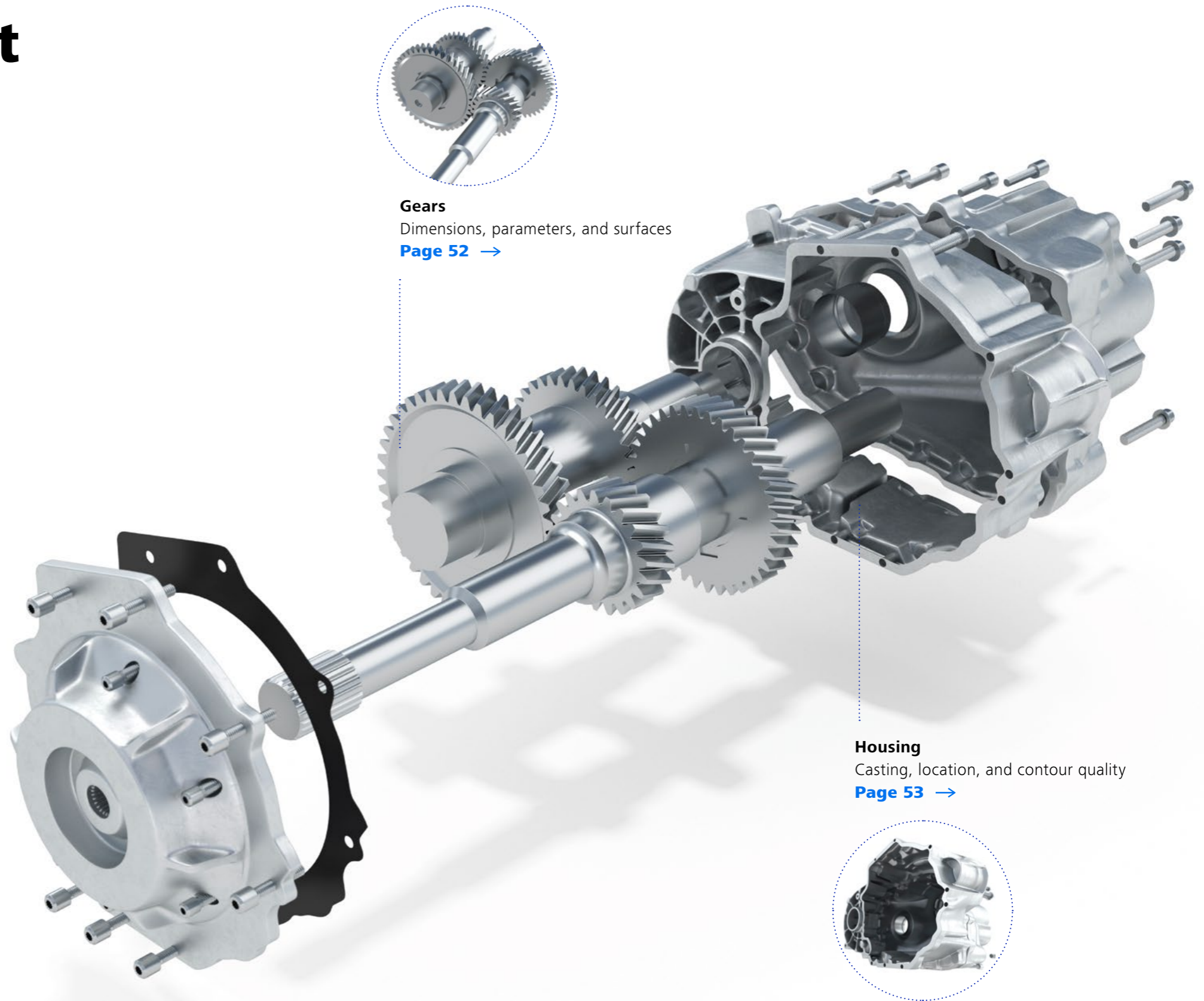

Gears
Dimensions, parameters, and surfaces
[Page 52](#) →

Housing
Casting, location, and contour quality
[Page 53](#) →

→ [Find the perfect product for your application: page 54](#)

Quality Assurance for Gears

Dimensions, parameters, and surfaces

Quality assurance for gears is always an important challenge, no matter whether vehicles are equipped with combustion engines, e-motors, or even hybrid engines. The number of geared parts inside electric vehicles is far lower than in vehicles with combustion engines. However, high speeds, high torques, and the goal of having silent, energy-efficient transmissions all make quality assurance a vital factor.

Dimensional Accuracy

Quality Challenges

- NEV gears have very tight tolerance requirements, often just a few μm
- Goal is to reduce noise and harshness at revolution speeds of up to 20,000 rpm
- These tolerances require fast, high-precision inspection equipment

ZEISS Solutions

- Gear metrology is best handled via a ZEISS CMM with a contact probing system and rotary table
- One solution measures all gear parameters as well as the shape, size, and location
- Ensures highest accuracy and flexibility



Complexity of Gear Parameters

Quality Challenges

- NEV gears, especially helical gears, are often optimized in relation to noise and efficiency
- This is achieved by means of gear flank modifications (e.g. crowning, relief, slope modification)

ZEISS Solutions

- Interactive, user-friendly gear metrology software is a powerful, reliable solution from ZEISS
- For increasingly complex requirements: noise, vibrations, and harshness
- ZEISS software offers the latest reporting and data management technology for many applications



Compressors and Pumps

Quality Challenges

- Since the e-motor is virtually silent compared to combustion engines, it is important to reduce any other noise
- This is caused by component shape, location, and size deviations as well as surface irregularities
- Roughness and waviness parameters also play an important role in noise reduction

ZEISS Solutions

- Collect all necessary data with ZEISS roughness and topography sensors
- These sensors can be equipped on ZEISS CMMs or offered as standalone high-precision systems

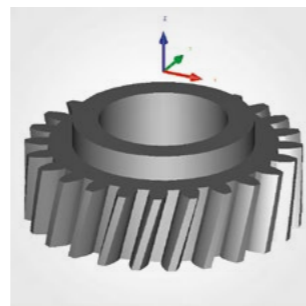

Quality Assurance for Housing

Casting, location, and contour quality

The electric motor and gearbox are usually located in the same housing, which therefore requires a highly complex design. Since the housing should remain as light as possible to boost vehicle range, it features very small wall thicknesses next to the parts. These walls are usually die-cast from aluminum and then machined by milling. The large number of machining steps means that many different geometric features must be measured on the housing.

Casting Inspection

Quality Challenges

- Cast aluminum housings have optimized shapes and thinner walls
- This enables improved cooling behavior, lighter weight, and extended range
- Defects in thinner cast wall structures can affect safety and cooling cycle of e-motor and transmission

ZEISS Solutions

- Effective detection of variances with ZEISS X-ray solutions
- This prevents defective parts from entering the machining process



Dimension and Location Measurement

Quality Challenges

- Integrating the e-motor and transmission into a single housing creates complex interdependent geometries within manufacturing process
- Tight tolerances for component shape, size, and location

ZEISS Solutions

- Meet all inspection requirements using ZEISS tactile active scanning combined with flexible and stiff probe systems plus a rotary table
- Evaluate and visualize even the smallest deviations with ZEISS Quality Software



Surface and Contour Quality

Quality Challenges

- Geometry, surface, and contour inspection of the housing is essential but time-consuming
- Would be much faster to measure all of these factors on a single machine

ZEISS Solutions

- Check all common surface parameters: tactile roughness sensor on ZEISS CMM
- Perform high-precision contour measurements
- Full-surface digitization of housing for automatic surface deviation detection (actual 3D coordinates vs. CAD data)



ZEISS Portfolio

Want to explore all hardware and software solutions across the entire ZEISS portfolio? Visit us at zeiss.com/metrology

Coordinate Measurement Solutions



ZEISS CMMs deliver stunning speed, accuracy, and flexibility, while ZEISS VMMs offer outstanding point density for fast optical measurement results.

ZEISS CALYPSO
ZEISS CALYPSO is your dimensional metrology software solution for CMMs.

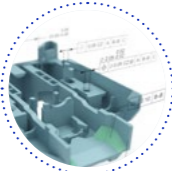

ZEISS Smart Services
ZEISS Smart Services boost safety, availability, and productivity.



Optical Solutions



ZEISS manual and automatic scanning delivers fast high-resolution results. ZEISS optical solutions enable dynamic object measurement to test for deformation or movement.

ZEISS INSPECT
ZEISS INSPECT Optical 3D software takes inspection and evaluation to a whole new level with features such as full-field data acquisition and trend analysis.

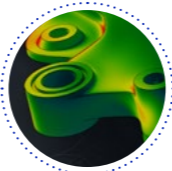

CT and X-Ray Solutions



2D and 3D X-ray solutions from ZEISS are ideal for fast and nondestructive scanning. ZEISS industrial CT performs measurement and defect analysis in a single X-ray scan, supporting fast handling even of parts with higher density.

ZEISS INSPECT
ZEISS INSPECT X-Ray software performs in-depth visualization using the data generated with ZEISS X-ray solutions.



Microscopy Solutions



ZEISS offers precision solutions in light, digital, electron, and X-ray microscopy, from specific surface inspection to general material characterization.

ZEISS ZEN core
The powerful imaging and connectivity software ZEISS ZEN core enables traceable analysis and ensures compliance with regulatory demands.

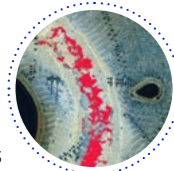

Supporting software

Data Management
ZEISS PiWeb scalable reporting and quality management software combines metrology results from different measuring technologies for efficient tracking of production quality. Its powerful features and intuitive templates handle huge amounts of data and provide immediate results.



Reverse Engineering
ZEISS REVERSE ENGINEERING surface reconstruction software promotes the automated, interactive, and highly precise creation of CAD models. The additional tool correction option helps improve CAD data quality.



Your Global Partner

Present in all regions

32

Sales & Service
Organizations

63

ZEISS Quality
Excellence Centers

100

Business Partners

10

Production Sites

As New Energy Vehicle components are rarely manufactured and assembled in a single location, measurement and inspection issues can occur in any country and at any supplier. Our global network of application engineers and service technicians provide quality assurance solutions to help you keep traceability and quality at a consistently high level. With a comprehensive knowledge base and the world's most accurate measuring machines, ZEISS strives to exceed expectations around the globe.

Find your perfect solution today.
Get in contact with our global experts.



info.metrology.us@zeiss.com



Carl Zeiss Industrielle Messtechnik GmbH

Carl-Zeiss-Straße 22
73447 Oberkochen

Vertrieb

Telefon: +49 7364 20 6337
E-Mail: sales.metrology.de@zeiss.com

Service

Telefon: +49 7364 20 6337
E-Mail: info.metrology.de@zeiss.com

www.zeiss.de/imt

Carl Zeiss Industrial Quality Solutions, LLC

6250 Sycamore Lane North
Maple Grove, MN 55369, USA

Phone: +1 800 327-9735
Fax: +1 763 533-0219
Email: info.metrology.us@zeiss.com

www.zeiss.com/metrology