

ZEISS eMobility Solutions



Seeing beyond

Power Electronics Component

Measurement by CMM

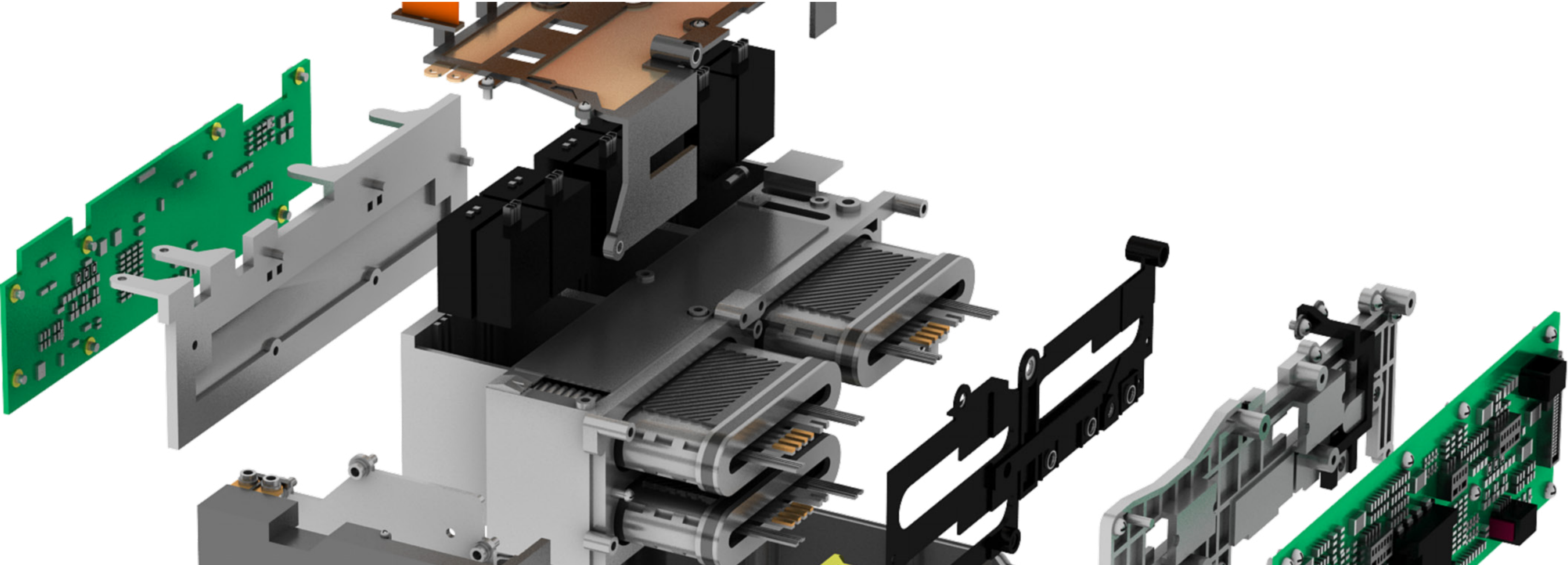

ZEISS eMobility Solutions

Power Electronics Component Measurement by CMM

Power Electronics quality control

Component metrology by CMM

As an important component responsible for power output in new energy vehicles, power electronics assemblies play a critical role in determining the vehicle's power performance and safety level.

With the electrification and increasing complexity of component structures, the reliability of the product has become increasingly important. Therefore, the demand for dimension measurement is growing in order to meet the comprehensive quality assessment requirements of the product as a whole. ZEISS provides solutions to enable faster and trustworthy inspection.



Enhance quality control of Power Electronics

Throughout manufacturing process

Power Electronics assembly follows a linear production process, with most components supplied externally and assembled in sequence. The connection of mechanical and electrical properties is achieved through methods such as screws and welding. As a complex assembly, the dimensional control of each component is crucial. Poor dimensions of multiple parts can lead to assembly issues of the entire product. Especially for electronic powertrain assemblies, they not only need to invert highvoltage electricity but also require waterproof and vibration-resistant capabilities.

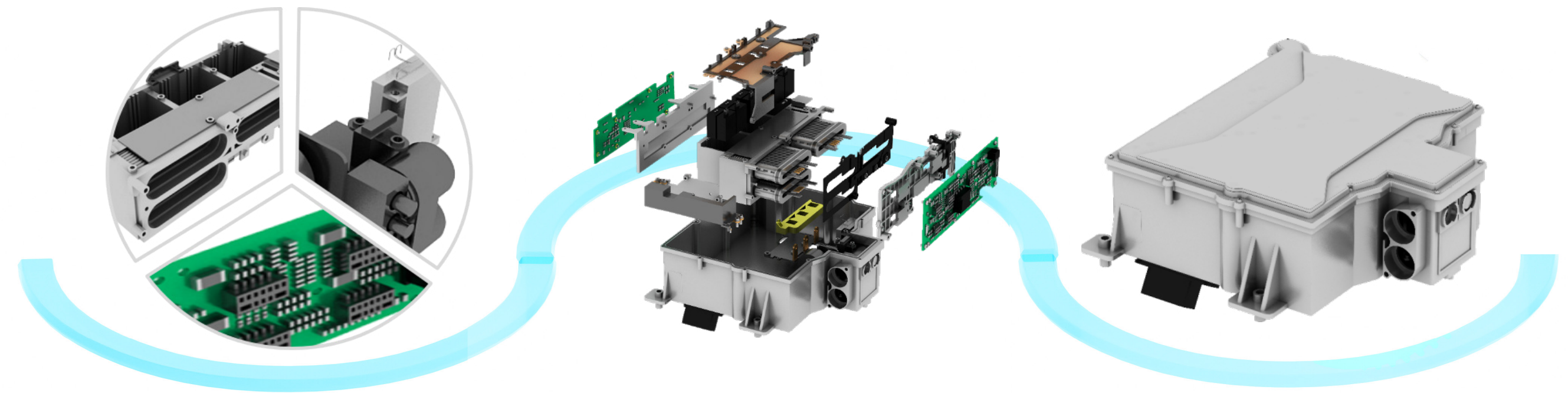

Sub-components

1. Die-casting
2. Injection molding
3. Semi-conductor

Production process

Assembly unit

Production process of Power Electronics

1 CMM Spot check

1. Components dimension measurement

Step 1
Cooling plate

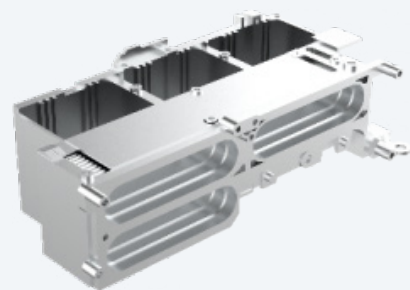

Step 2
Power module & Cap

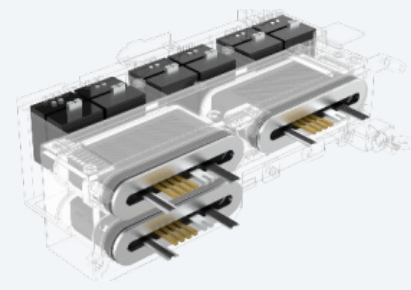

Step 3
Busbar & AC output

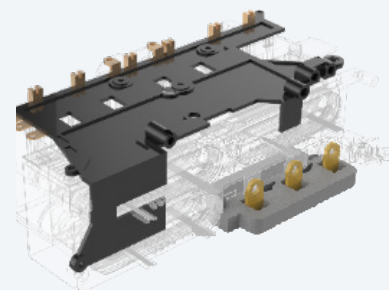

Step 4
PCBA & Cable

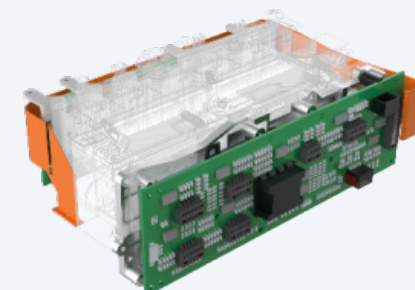

Step 5
Housing

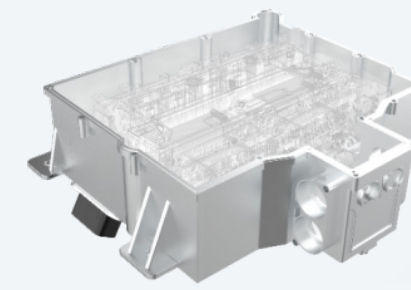

Step 6
Input filter

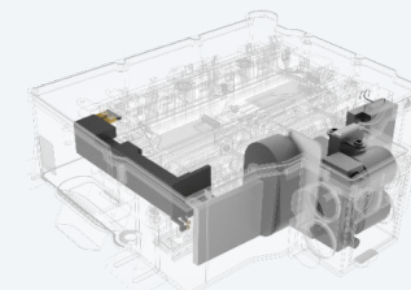

Step 7
Assembled unit

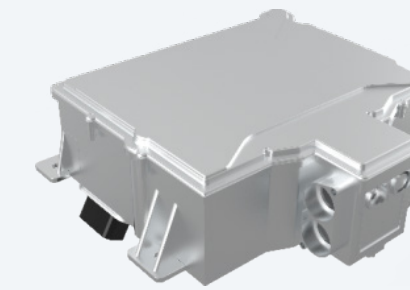

2 CMM Spot check

1. Whole unit dimension measurement

Application areas of power electronics component by CMM



Quality lab

- Fast and reliable dimensional inspection of incoming materials
- High-precision inspection of machined areas

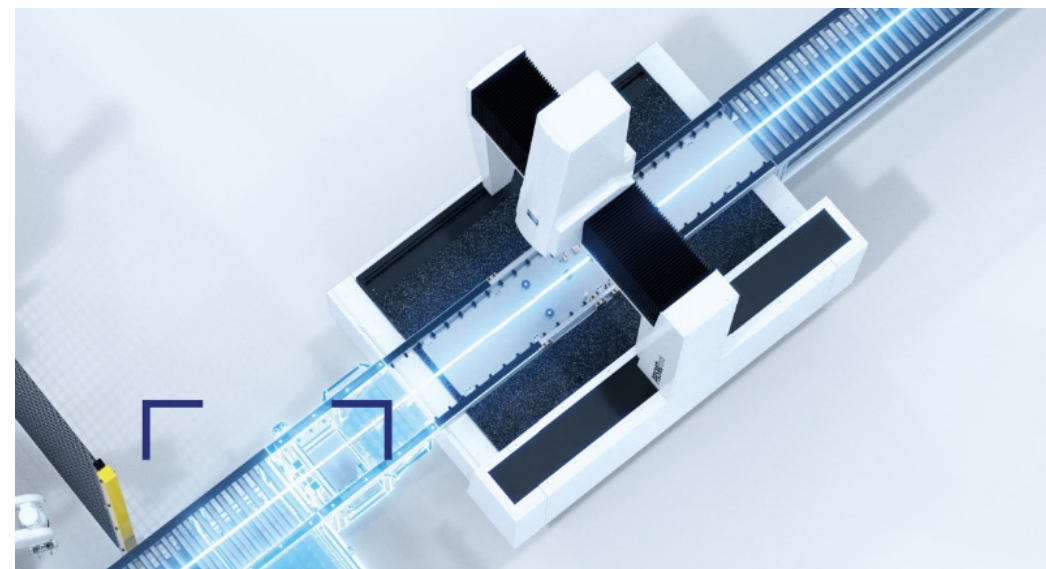

At-line measurement

- Inspection of special feature dimensions during process steps
- Inspection of mating end positions of offline products



Value proposition of ZEISS solution

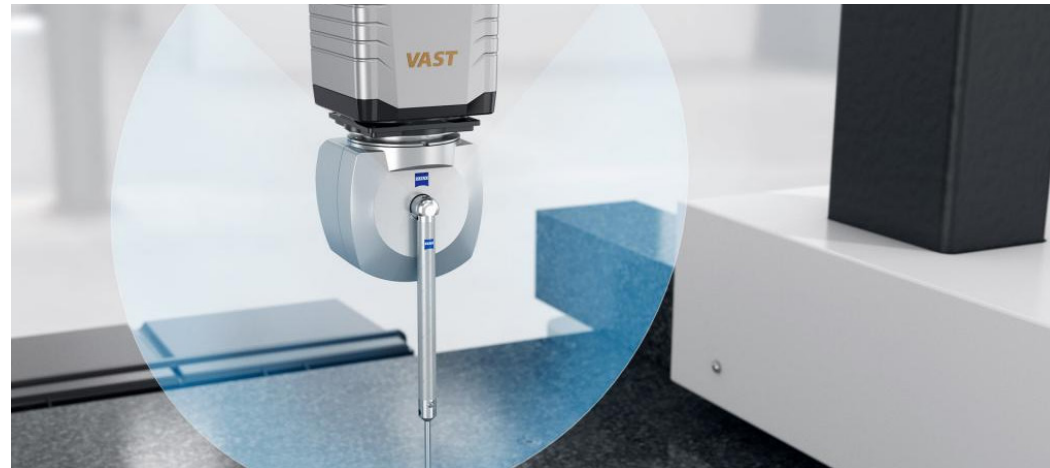

Increase efficiency with high-speed scanning

- Four-axis linkage with rotary table provides fast & precise measurements; ZEISS VAST scanning technology guarantees <math>< 1 \mu\text{m}</math> repeatability error at 50mm/s speed
- ZEISS fly scan technology saves 70% probing time and automatically avoids irregular areas

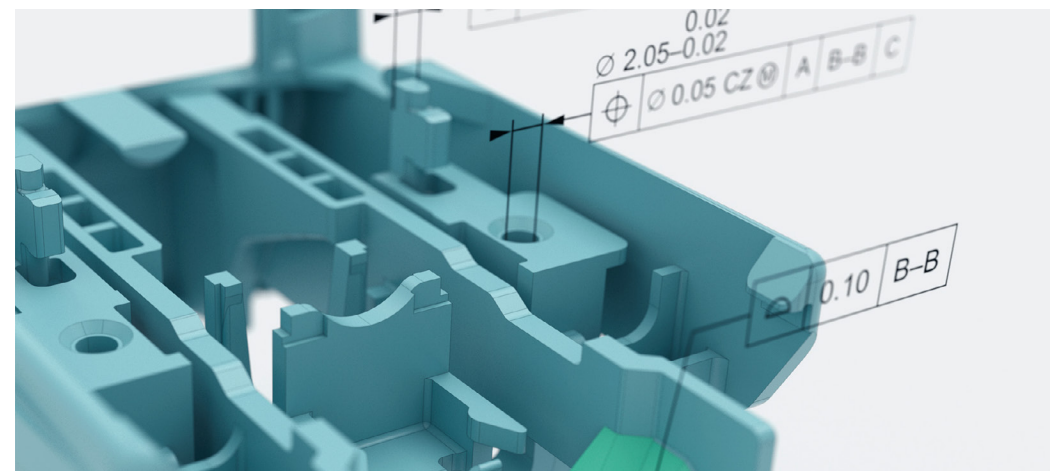

High efficiency by one-stop system ZEISS CALYPSO

- Measure geometrical elements simply, quickly and reliably
- Enable to combine tactile, optical and multi-sensor CMM as well as roughness sensors in a single inspection plan
- Create inspection plans with just a few simple clicks and without any programming skills



High reliability with ZEISS inline CMM solutions

- With strong stability and scalability, the CMMs can be directly integrated into the production line
- It can maintain an accuracy of $2.7 + L/80 \mu\text{m}$ at an ambient temperature of 40°C



Increase efficiency with multiple sensors

- Multiple sensors guarantee capability of measuring all quality requirements
- Non-contact measurement can stably detect products such as smooth machined surfaces and low-hardness surfaces
- Complex structures that are difficult for contact probes to reach can be measured by optical probes

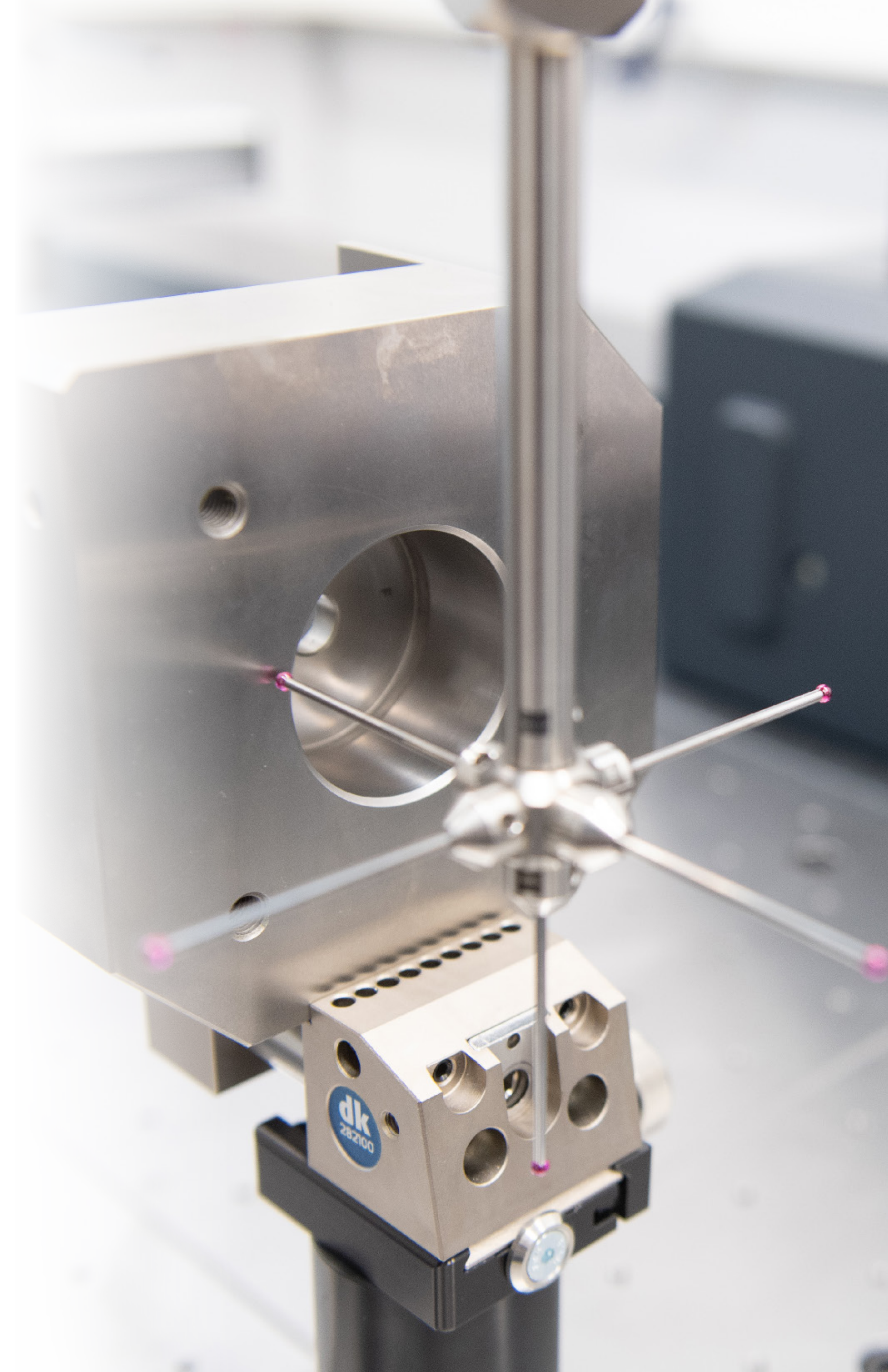

Recommended portfolio

Prepared for all challenges-today and tomorrow

ZEISS CONTURA 7/7/6

| | |
|--|------------------------------------|
| Length measurement error in μm : MPE_E0 | $1.5 + L/350$ |
| Max. Travel speed vector V_{max} | $475 \frac{\text{mm}}{\text{s}}$ |
| Max. vector acceleration | $1,85 \frac{\text{m}}{\text{s}^2}$ |
| Max. Scanning speed | $150 \frac{\text{mm}}{\text{s}}$ |
| Measuring sizes | 700mm*700mm*600mm |

Benefits: ✓

- ZEISS multi application sensor system (MASS) allows for tactile, optical, and roughness measurements to be performed on the same ZEISS machine.
- ZEISS RDS sensor is capable of reaching almost any position of each component with a step size of 2.5 degrees.
- ZEISS ViScan 2D optical probe offers full flexibility for fast measurements.
- ZEISS DotScan, a confocal white light probe, is particularly suitable for measuring sensitive surfaces.
- ZEISS LineScan enables rapid point cloud scanning, allowing for comparison with nominal CAD data or the creation of new CAD models.

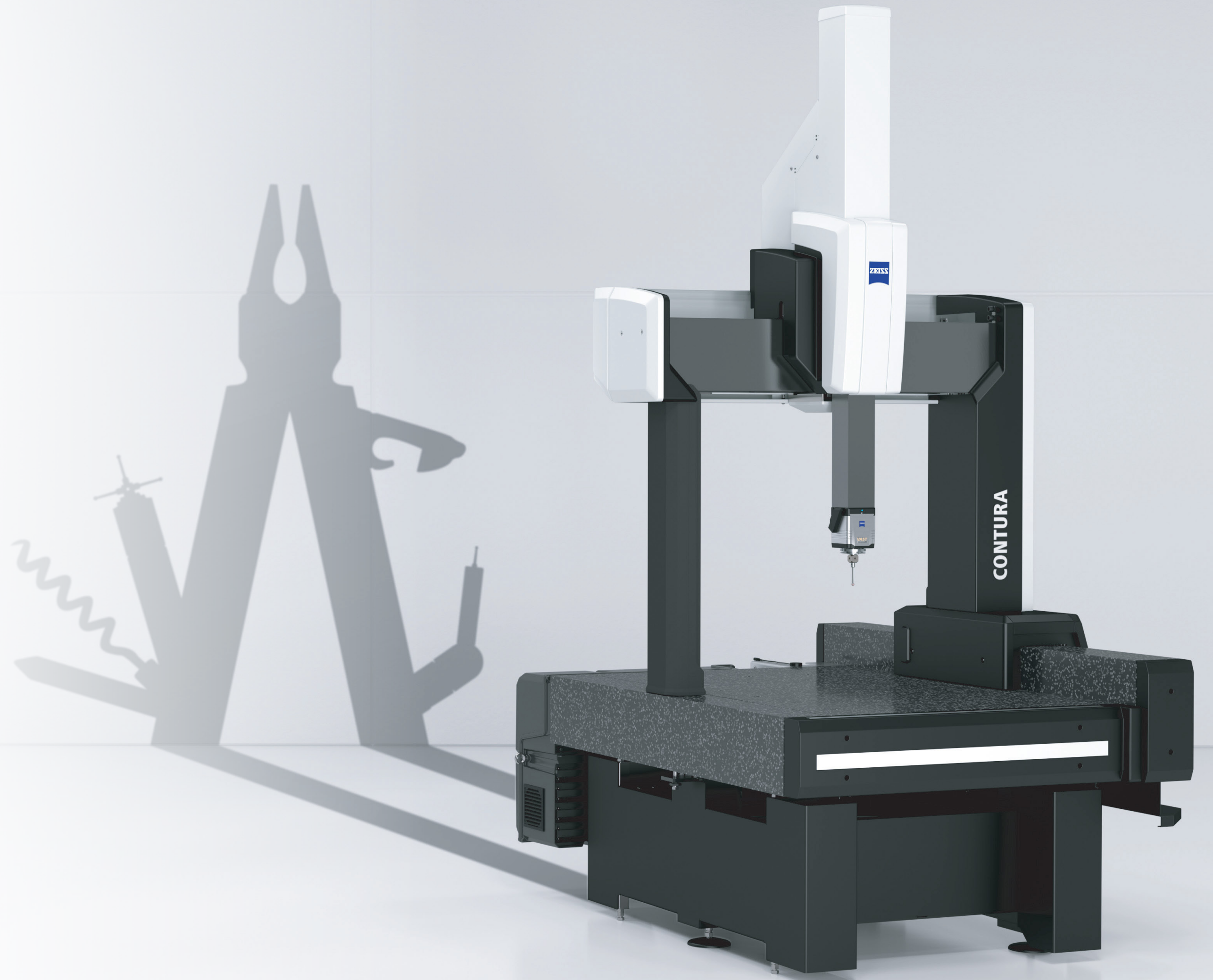

Recommended portfolio

High precision and speed ZEISS PRISMO Family



Length measurement error: MPE_E0 0.5 + L/500 µm-
0.9 + L/350 µm

Measuring sizes 7/9/5 - 16/42/14

ZEISS mass technology As standard

Benefits: ✓

- ZEISS multi application sensor system(MASS)allows for tactile, optical, and roughness measurements to be performed on the same ZEISS machine.
- ZEISS RDS sensor is capable of reaching almost any position of each component with a step size of 2.5 degrees.
- ZEISS PRISMO ultra guarantees top accuracy up to 0.5 + L/500 µm
- ZEISS VAST Rotary Table Axis (ZVRA) defines the axis of the rotary table for accurate and reliable measurement

Precision in every environment ZEISS DuraMax / DuraMax HTG



Length measurement error: MPE_E0 2.2 + L/300 µm-
2.5 + L/300 µm

Measuring sizes 5/5/5 - 16/42/10

Working Temperature +18°C to +30°C +15°C to +40°C(DuraMax HTG)

Benefits: ✓

- ZEISS DuraMax combines robustness, precision and efficiency, making it the perfect choice for at-line measurement directly in your production hall.
- ZEISS DuraMax is not deterred by harsh environmental conditions and withstands even high temperatures.
- In conjunction with the ZEISS VAST XXT-Sensor it enables fast single-point measurements as well as scanning of contours and free-form surfaces, making fixed gauges superfluous.

ZEISS CMM software CALYPSO

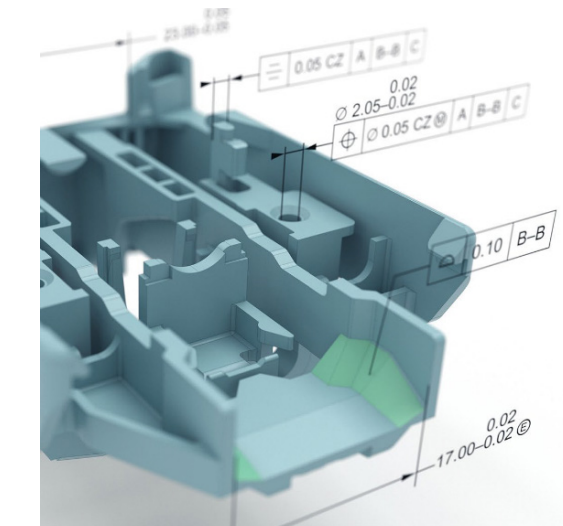

Installation possibilities

CALYPSO planner
CALYPSO simulation
Automation
Reporting

Performance enhancer

VAST probing
VAST navigator
VAST performance

Benefits: ✓

- ZEISS CALYPSO VAST probing significantly reduces the time required for single point measurements with accuracy and fast single point detection.
- ZEISS CALYPSO VAST navigator improves scanning operations of VAST series tactile measurement machines by improving accuracy and significantly reducing the measurement time of circular paths.
- ZEISS CALYPSO pallet optimizer reduces the number of sensor and stylus system changes during a pallet measurement in an automated way.

38
Sales & Service
Organizations

63
Quality
Excellence
Centers

11
Locations

245
Sales Partners
Worldwide

Global Metrology Network

Our global service network provides easy access to ZEISS expertise around the world. We use local teams to ensure a swift response and reduced downtime. Make your operations even more secure and reliable with ZEISS.

Find your perfect solution today.
Contact our global experts.

