



ZEISS AIMax twin and ZEISS AIMax twin UV
Product information



Measurement of gap and flush along the entire process chain

The double-head sensors ZEISS AIMax twin and ZEISS AIMax twin UV inspect gap and flush values on each vehicle a company manufactures and are indispensable management tools for the production processes. The enhanced ZEISS product portfolio and the extension of the proven AIMax family ensure closed-loop in-line process control every step of the way and across all production facilities.

ZEISS in-line double-head sensors

Like the proven ZEISS AIMax, the ZEISS AIMax twin and ZEISS AIMax twin UV can both be used as part of the 100% inspection for flush and gap measurements - and in any type of production facility: from car body construction all the way to final assembly of the finished vehicle.

Early detection of gap and flush values can prevent the need for extensive and costly subsequent reworking. Cross-facility, in-line performance tests not only have a positive impact on the subsequent tightness of the vehicle and ensure correct door closing forces, but also enhance the customer's driving experience by reducing driving noise. Various factors which can influence the dimensional stability of the hang-on parts, e.g. temperature fluctuations, tension release, vibrations, mechanical and chemical processes, result in process influences throughout the entire production process. 100% inspection of the gap and flush values therefore is indispensable for the control of production processes.

Measurement of gap and flush values along the entire line, based on the example of single-head and double-head sensors



ZEISS AIMax

is used in automated in-line gap and flush inspection and here inspects the optical gap on metal and painted surfaces.



ZEISS AIMax with single sensor technology

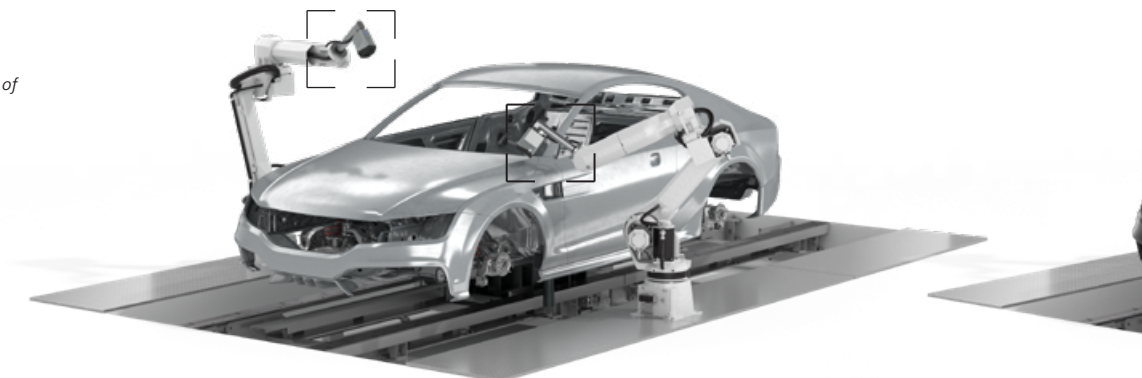

SUPPLIER // HANG-ON PARTS

Dimensional stability of hang-on parts

ZEISS PiWeb

BODY CONSTRUCTION

Assembly processes, dimensional stability of body and hang-on parts

ZEISS PiWeb

PAINTING

Heat input, temperature

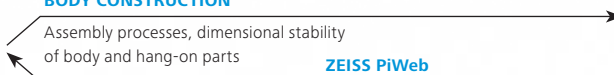
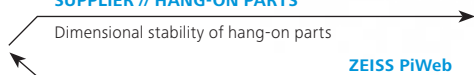

2



ZEISS AIMax twin
is used to capture the geometric dimensions of the gap and the flush on metal and painted surfaces.

3



ZEISS AIMax twin UV
inspects the gap and flush values on painted and metal surfaces, as well as on non-cooperative and transparent surfaces.



ZEISS AIMax twin and UV with double-head sensor

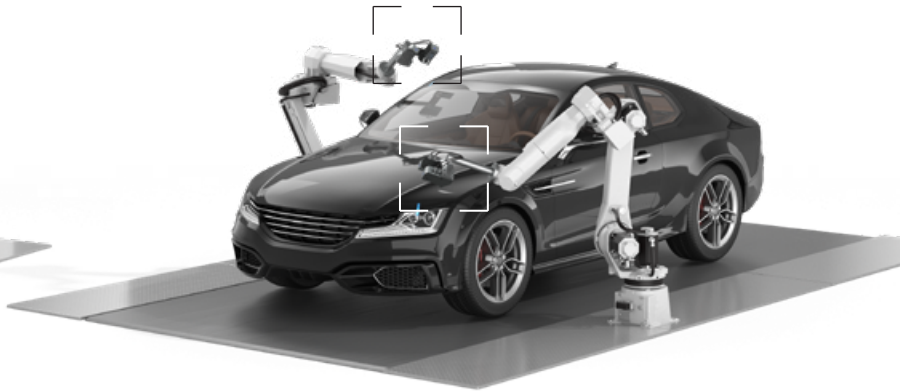
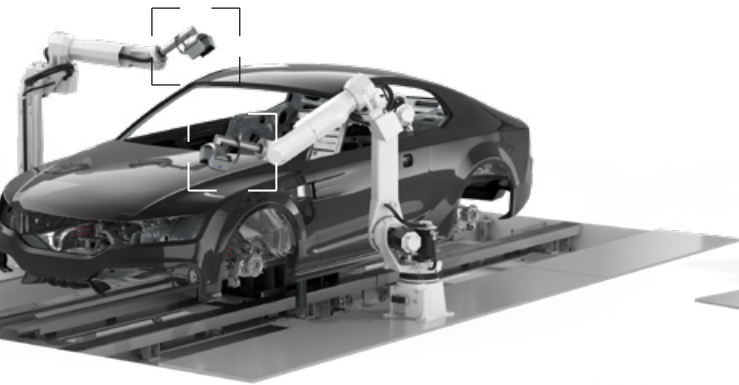

Dimension release, vibrations, cataphoretic painting
ZEISS PiWeb

FINAL ASSEMBLY
Force exerted on vehicle on wheels, door upgrade
Removal/installation of doors
ZEISS PiWeb

Created for the gap

ZEISS AIMax & AIMax twin & ZEISS AIMax twin UV

100% capture of the gap and flush values in each process step helps detect deviations immediately, thus reducing the amount of rework required in downstream departments drastically. By means of automated capture, ZEISS generates short control loops through the visualization and feedback of values and tolerance deviations, even on varying and non-cooperative surfaces.

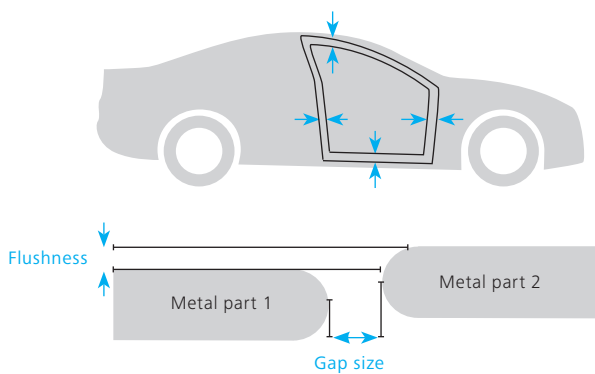

Presentation of gap size and flushness between metal parts

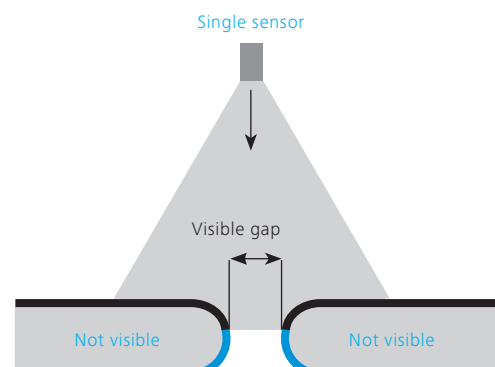

Presentation of single-sensor technology and optical gap

Single-sensor and double-head sensor technology

To date, gap and flush values frequently have been inspected manually using geometric and fan gauges. The previous, partially manually performed, method of gap inspection is now a thing of the past. ZEISS offers a variety of sensor variants for the inline automatic acquisition of gap and flush measurements.

The ZEISS AIMax family is thus used optimally, according to the application involved. The ZEISS AIMax can be used inline for feature measurements, e.g. of bolts, as well as for gap and flush measurements. It features three measurement principles in only one sensor. The flexible illumination control provides optimal object illumination for ideal contrast of difficult to measure features and gaps. Thanks to its double-head sensor technology, the ZEISS AIMax can measure and evaluate these values geometrically from two directions. The result is an even more precise inspection with more information which can be restored to the process.

A large number of gap and flush lines on the vehicle are located in relevant visual zones and are often created by adjacent components made of various surface materials, e.g. glass, plastic, chrome and rubber seals. For this reason, the

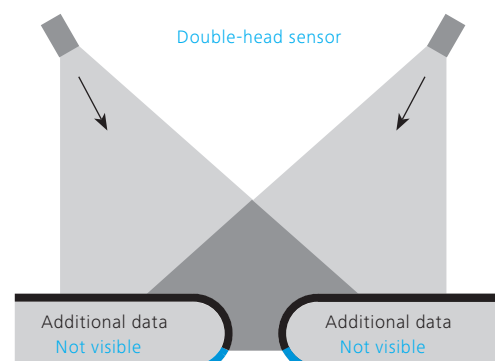

Presentation of double-head sensor technology and geometric gap

inspection of these customer-relevant gap and flush values has increasingly come to the fore. This supreme discipline, i.e. the measurement and inspection of various non-cooperative materials, has been mastered by the ZEISS AIMax twin UV.

1. The ZEISS AIMax measures the optical gap on painted and metal surfaces.

The sensor is used in the automated inline gap and flush inspection of metal and painted surfaces, along the entire production line. The sensor combines three measuring principles: gray-scale image processing, multiline triangulation and shadow evaluation. A flexible illumination control provides optimal object illumination and ideal contrast for the inspection of the optical gap.

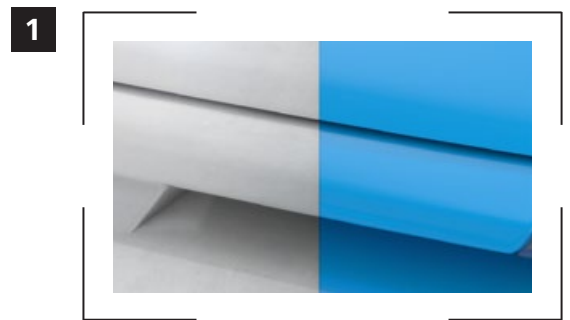

2. The ZEISS AIMax twin measures the geometric gap on painted and metal surfaces.

The ZEISS AIMax twin double-head sensor is used to capture the geometric dimensions of the gap and the flush on metal and painted surfaces. Thanks to the dual head, it is possible to inspect the geometric gap in that the sensor looks directly into the gap on painted and unpainted surfaces, from car body construction through painting processes, and all the way to final assembly.

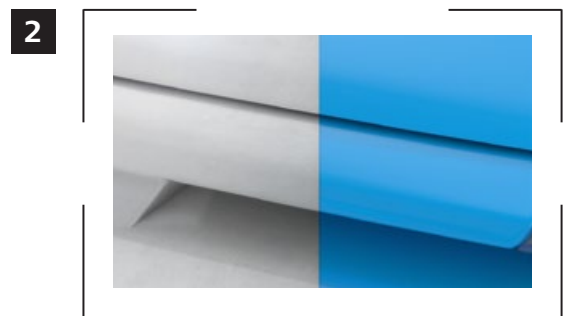

3. The ZEISS AIMax twin UV measures the geometric gap on various surfaces.

This sensor takes the capture of gap and flush values one step further: in addition to painted and metal surfaces, it is now possible to obtain these values on non-cooperative and transparent surfaces, e.g. glass and plastics.

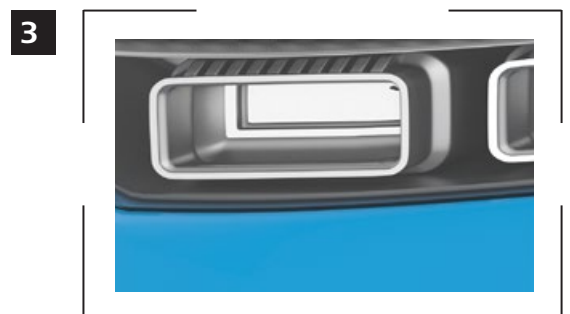

Overview of gap and flush measurements on the entire car body and on various surfaces

A consistent inline inspection of all required gap and flush values from the car body to the finished vehicle guarantees a mutual best fit of all parts of the finished vehicle on wheels.



E.g. gap and flush on the painted car body with nine measuring points (gap specifications: in the range of 3,4 mm \pm 0,5 mm to 4,4 mm \pm 0,5 mm).

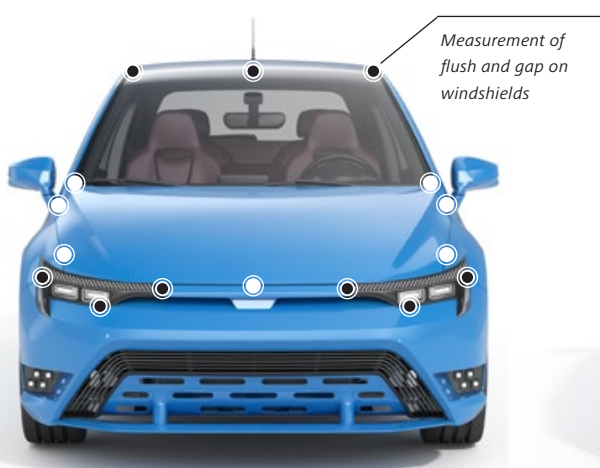

E.g. gap and flush on the painted car body with 16 measuring points, six of which are located in the area of the headlamps (gap specifications: from 0.8 mm \pm 0.8 mm to 4.4 mm \pm 0.6 mm).

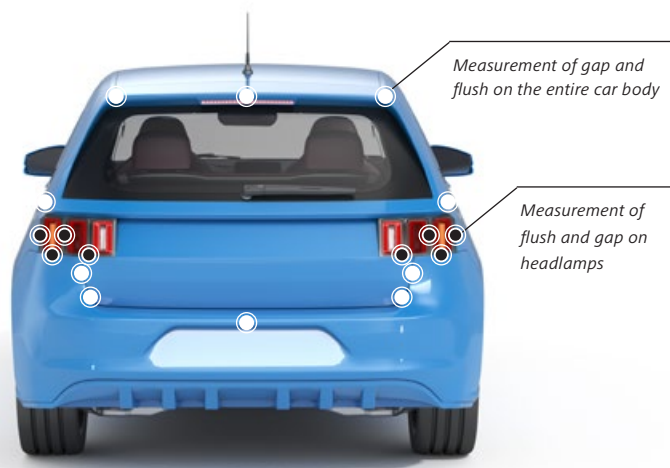

E.g. gap and flush in the rear area of the painted body with 18 measuring points, six of which are located in the area of the taillamps (gap specifications: from 1.0 mm \pm 0.5 mm to 5.5 mm \pm 0.5 mm).

Gap and flush & surface inspection

in a cell with ZEISS ABIS and ZEISS AIMax twin

A further inline solution is offered by ZEISS in the form of a combination automated surface inspection and inline gap and flush measurement within a single cell.

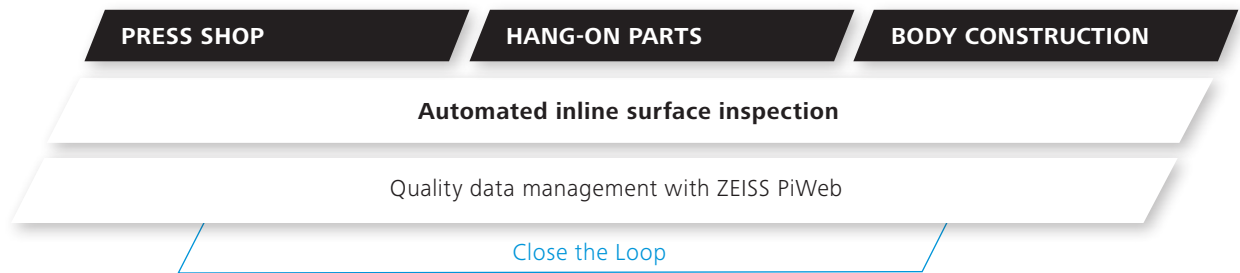

Combination of automated surface inspection and inline gap and flush measurement within a cell

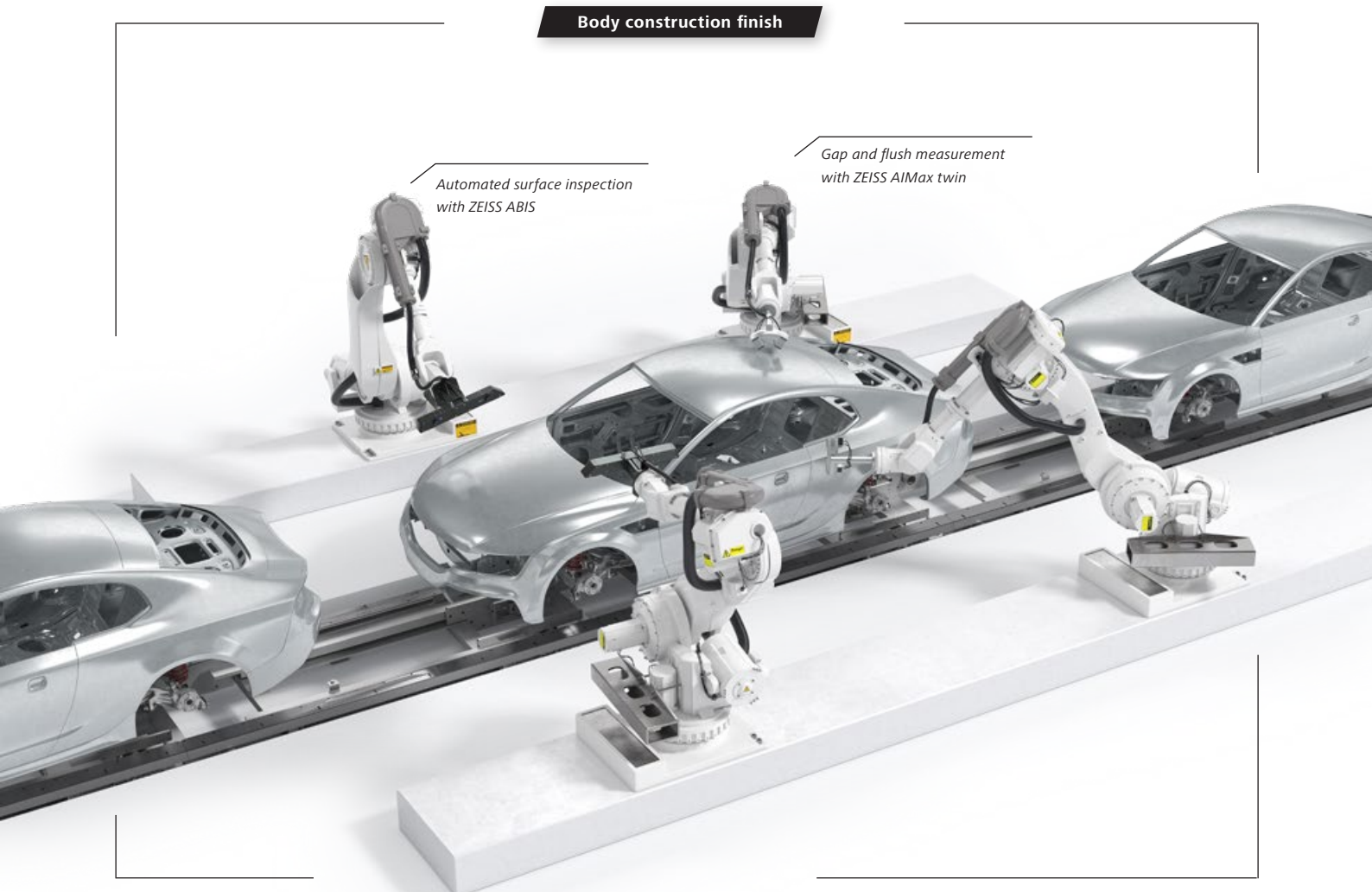

**Carl Zeiss
Industrielle Messtechnik GmbH**

73446 Oberkochen/Germany
Sales: +49 7364 20-6336
Service: +49 7364 20-6337
Fax: +49 7364 20-3870
info.metrology.de@zeiss.com
www.zeiss.de/imt

**Carl Zeiss
Industrial Metrology, LLC**

6250 Sycamore Lane North
Maple Grove, MN 55369/USA
Phone: +1 763 744-2400
Fax: +1 763 533-0219
info.metrology.us@zeiss.com
www.zeiss.com/metrology