

# Some things are made for each other



## ZEISS Stylus System Components

For guaranteed precision and reliable measurement results  
use certified original accessories

Version 05.24

[probes.zeiss.com](https://probes.zeiss.com)



Seeing beyond



# Made to be precise

## ZEISS Original Accessories

### ZEISS Adapter Plates

Only original ZEISS adapter plates can ensure that the measurement uncertainty of the CMM is maintained, and its full potential is used. Apart from the high quality, which ZEISS closely and continuously monitors, more important reasons speak for using certified ZEISS adapter plates: improved quality of measurement results, higher productivity and increased system stability.

#### Measuring uncertainty

**up to 5x lower**  
than for Non-ZEISS adapter plates

### ZEISS REACH CFX

#### Carbon fiber extensions

The overall influence of the extension on the measuring uncertainty is mainly determined by three factors: weight, thermal expansion and static stiffness. At ZEISS only high-quality carbon fiber is used giving the best possible results for all three factors.

#### Measuring uncertainty

**up to 3x lower**  
than for Non-ZEISS extensions

### ZEISS Styli

Quality of styli is determined by the highest possible stylus rigidity, the geometric accuracy of the stylus element and the maximum roundness of the measuring probe sphere. The strict ZEISS process controls in manufacturing guarantee styli quality of the highest order. Thanks to the latest production technologies, our styli are particularly precise, stable and durable.

#### Measuring uncertainty

**up to 3x lower**  
than for Non-ZEISS styli

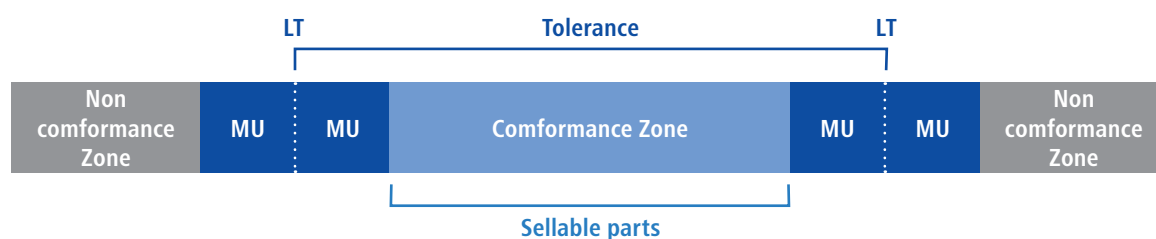

ZEISS Original Accessories enable you to reliably deliver high quality products by minimizing the measurement uncertainty (MU) for each individual measuring point.

# For guaranteed precision and reliable measurement results

## The ideal stylus system

- has as few joints as possible
- is as rigid as possible
- weighs as little as possible
- is as temperature-resistant as possible

**Only use certified original accessories for your ZEISS measuring system. This is the only way to guarantee maximum precision and compliance with the specifications of your measuring system.**



## Stylus tip

The stylus is the “tip” of the stylus system and is the first point of contact to the workpiece. Three factors must be taken into account when choosing a stylus tip: the stylus specifications, and the shape and material of the tip. The most frequently used stylus tip is the ball tip. Dimensional accuracy and the material are what count here.

## Tip material



**Silicon nitride**  
Used for the most common measurement tasks. Particularly suitable for scanning aluminum surfaces.



**Tungsten carbide**  
High weight but allow special diameters such as for gear measurement. Can be made to specification.



**Rubin**  
The most used sphere material in metrology and suitable for the most common measurement tasks. Very small spheres can be produced.



**Ceramic**  
Very low porosity. Available as high-precision variants, in large sphere diameters and as weight-optimized (hollow) hemispheres. Particularly suitable for scanning rough surfaces such as cast iron.



**Diamond coated**  
Less wear and material buildup. Particularly suitable for scanning soft materials as well as measuring glass and mirror surfaces.



**Diamond**  
Almost no wear and no material buildup during scanning. Ideal for measuring very hard or highly abrasive workpieces.

## Material wear or build-up

Even high-quality probes are consumable items that must be checked regularly. This is the only way to prevent measurement inaccuracies. cast iron.

## What can be done about it?

Our expert tips:



## Shaft

All styli generally should be as resistant to bending as possible in order to properly register the measuring force, largely without any deformation or so-called “stylus bend”. The shaft material used and the shaft cross section have the greatest influence on shaft rigidity.

## Design and material

### Ceramic

High stiffness with low weight and are therefore particularly recommended for long stylus shafts where weight is a critical factor.

### Carbon fiber

Optimum combination of stiffness, weight, and thermal linear expansion. This makes them particularly suitable for long styli and demanding measurement tasks. Also ideal for magnetic applications.

### Tungsten carbide stepped

Advantage of a greater shaft thickness, which is reduced towards the probe element. Increases the stability of the stylus while maintaining the same length (usable measuring length is reduced as a result).

### Tungsten carbide straight

Good combination in terms of weight, stiffness, and thermal linear expansion. The simplest stylus design and the one with the longest usable length.

## Adapter

The adapter forms the connection between the connecting thread and the shaft. It is important that the adapter is structurally designed so that it can optimally take up the measuring force introduced via the shaft.

## Adapter thread

Depending on the measuring system used, ZEISS offers different connecting threads that consist of high-strength titanium alloy.



## M3 XXT stylus

The ZEISS M3 XXT stylus features a much higher rigidity than conventional M3 styli. This rigidity is achieved through the 1 mm larger diameter of the XXT adapter's base body and the titanium alloy used.

## Important

When assembling your stylus systems, always make sure that the joints are clean to ensure optimal traction.





Whether styli, adapter plates or extensions: Only original accessories from ZEISS will enable you to get the most out of your ZEISS measuring system.

Find the perfect components for your individual stylus system now in our ZEISS Metrology Shop:



[shop.metrology.zeiss.com](https://shop.metrology.zeiss.com)

## Extension

Extensions help set up complex stylus systems. All extensions should be as rigid, light and thermally stable as possible. The use of unsuitable extensions has a direct negative influence on the measuring uncertainty of the overall system and thus worsens the accuracy that a CMM can achieve according to the specification.



**ZEISS REACH CFX has up to 5 times less influence on the measurement uncertainty of your CMM compared to titanium.**

- Increased productivity - thanks to the increased static stiffness, significantly higher scanning speeds are possible while maintaining the same level of accuracy
- Suitable for all measuring environments - thanks to increased temperature resistance
- Three accuracy levels - always the right solution for your CMM

Which extension fits your CMM best?  
Find out online:



## Adapter plate

The adapter plate connects the stylus system with the measuring head and is therefore the central interface between the CMM and the workpiece. It is precisely here that no compromises should be made. Only adapter plates with the highest accuracy can achieve the given machine specifications. With the certified ZEISS adapter plates, you can exploit the full potential of your CMM.

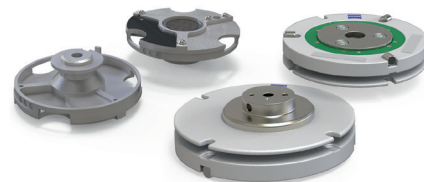

- Up to 30% faster stylus changes due to highly accurate manufactured and certified adapter plates
- Avoiding operating errors and incorrect measurements – thanks to integrated ID chip
- More robust data transmission due to refined bearing points
- Reduction of the measuring time by up to 70% – due to possible use of the FlyScan function

Use the full potential of your CMM now.  
Discover original adapter plates from ZEISS:



# Just grab it online

## ZEISS Metrology Shop

With just a few clicks, all ZEISS accessories shown in the catalog are also online available in our ZEISS Metrology Shop.

With the ZEISS ID, you can conveniently shop around the clock in the ZEISS Metrology Shop and benefit from faster order processing and delivery thanks to automated ordering processes, as well as other advantages.

### Your ZEISS Metrology Shop advantages:



#### Fast Quotes and Orders

Receiving quotes in seconds and placing an order quickly - without waiting time



#### Easy Payment Methods

Easy payment by invoice, credit card or ZEISS Metrology Credit



#### Product Favorites Lists

Save valuable time on recurring orders for certain products.



#### Shopping Cart

Get the opinion of your colleagues or the approval of your manager by simply sharing your shopping cart

### Even more useful ordering tools:

- ZEISS Metrology Credit accelerates your internal approval processes
- We can take care of customized styli
- Benefit from promotional actions and discounts
- Same day shipment possible, if you place your order before 10:00 am Central Time
- Free return of your order possible, if you are not satisfied

Note: not all features are equally available and applicable in all ZEISS Metrology Shops in all countries. There may be differences in the individual online shops.

### Still need a ZEISS ID?

It's easy to get one. Just use the link below and fill out the form. With the ZEISS ID you will also benefit from access to digital ZEISS metrology services in the online shop.



[probes.zeiss.com](https://probes.zeiss.com)

### Just grab it online now!

Simply select your country under the following link and you will have access to the largest standard portfolio of ZEISS accessories, software and training on the market.



[probes.zeiss.com](https://probes.zeiss.com)

## M5

Reference styli .....	14
Standard styli.....	15
Diamond!Scan® .....	94
L-styli and -elements.....	98
T-styli and -elements.....	102
Star styli and -elements .....	104
Cylinder styli .....	108
Disc styli .....	112
Discs.....	114
Hemisphere styli .....	116
Cone shaft styli.....	117
Long threaded styli.....	118
High precision.....	119
Special diameter .....	122

## M3 XXT

Reference styli .....	131
Standard styli.....	132
Knurled styli.....	152
Clamping styli .....	154
Diamond!Scan® .....	155
Cylinder styli .....	158
Hemisphere styli .....	161

## M3 Renishaw

Standard styli.....	163
Cylinder styli .....	195

## M2

Reference styli .....	199
Standard styli.....	200
Cylinder styli .....	220
Disc styli .....	222

## Styli without thread

Standard styli.....	224
Pivot styli .....	229

## Extensions

### M5 carbon fibre plate extensions

ZEISS REACH CFX® 3, M5 .....	232
ZEISS REACH CFX® 3, M5 Pro .....	235
ZEISS REACH CFX® 5, M5 .....	240
ZEISS REACH CFX® 3, MMZ .....	241

### M5 carbon fibre standard extensions

ZEISS REACH CFX® 1 .....	245
ZEISS REACH CFX® 3 .....	247
ZEISS REACH CFX® 5 .....	251

## M5 pro carbon fibre extensions

ZEISS REACH CFX® 3 M5 pro .....	254
---------------------------------	-----

## M5 Titanium standard extension

Titanium connectors .....	258
---------------------------	-----

## M3 XXT carbon fibre extensions

ZEISS REACH CFX® 1, M3 XXT .....	261
----------------------------------	-----

## M3 (touch-trigger) extensions

Steel standard extensions (Inox) .....	265
Titanium standard extensions .....	266

## M2 extensions

Steel standard extensions .....	268
---------------------------------	-----

## Adapter plates

---

### VAST/VAST Gold

Reference adapter plate VAST/VAST Gold .....	271
Adapter plates VAST/VAST Gold Standard .....	272
Adapter plates VAST/VAST Gold M5 Pro .....	273
Adapter plates for RST-T temperature probe head .....	275

### VAST XTR

Adapter plates VAST XTR Standard .....	277
Adapter plates VAST XTR M5 Pro .....	278

### VAST XXT

VAST XXT TL1 .....	280
VAST XXT TL3 .....	282
VAST XXT TL4 .....	284

### Accessories for adapter plates

Collision protection for adapter plates VAST/VAST Gold .....	287
Labeling for VAST/VAST Gold adapter plates .....	288
Cubes and adapter for VAST/VAST Gold adapter plates .....	289

## Connection Elements

---

### M5

Knuckles and rotary elements .....	295
Inserts with cone adapter .....	297
Screws .....	302
Styli holders .....	304
Adapters .....	306
Angles .....	307
Counterweights .....	308
Cubes .....	309
Multi sided cubes .....	311

### M5 Pro

Knuckle and rotary elements .....	314
Screws .....	315
Adapters .....	316
Angles .....	317





Multiple holders..... 321

**M3 XXT**

Knuckle and rotary elements ..... 324  
Inserts with cone adapter ..... 326  
Screws ..... 329  
Adapters ..... 330  
Counterweight ..... 331  
Cubes and various elements for clamping ..... 332

**M3**

Knuckles and rotary elements ..... 336  
Adapter ..... 337  
Cubes ..... 338

**M2**

Knuckle and rotary elements ..... 340  
Adapters ..... 342  
Cubes ..... 343





# Stylus Systems

Stylus systems are the first contact to the workpiece

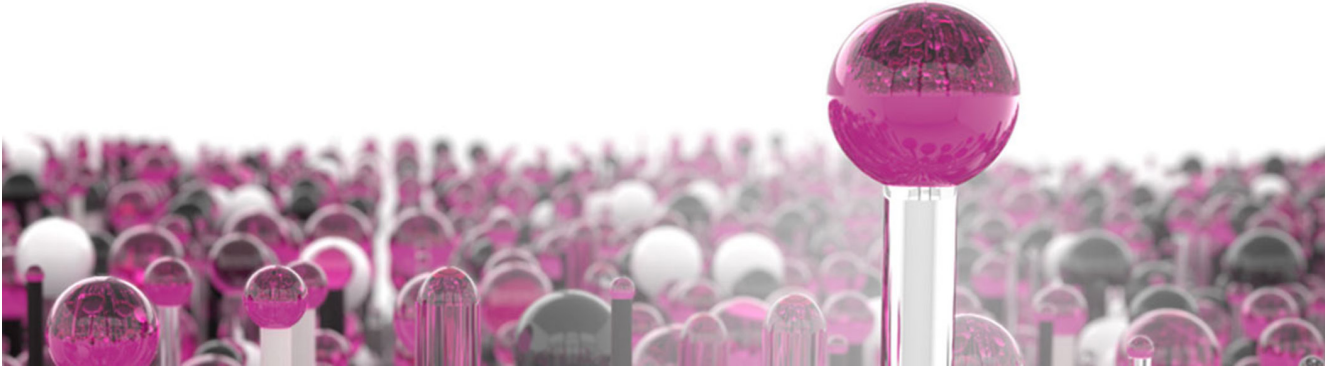

The stylus system plays a central role in contact measuring technology. It is the first point of contact to your workpiece. From the diamond stylus to the angle setting device - the stylus system accessories from ZEISS have been developed to meet the special requirements of your measuring jobs. Use only certified original accessories for your ZEISS measuring machine.



## ZEISS components for all probing systems - for guaranteed precision and reliable measuring results

All ZEISS accessories are subject to the strictest quality criteria and are constantly optimized. In a time-consuming testing procedure, each individual product is checked for usability on ZEISS machines, so that it can be ensured that the specifications of the machine such as accuracy or performance are not limited by accessory components. This allows you to significantly reduce the overall measuring uncertainty of your measuring job, meaning that a maximum number of good parts can be delivered that are clearly within the tolerance range. Unsuitable components can significantly reduce the achievable accuracy of the CMM, which can lead to an increased error rate. We therefore recommend our original ZEISS accessories, specially developed and tested for ZEISS measuring systems.

## ZEISS stylus systems - fully assembled, aligned and with their own SAP number

The ideal stylus system:

- has as few connection points as possible.
- is as stiff as possible.
- weighs as little as possible.
- is as temperature-resistant as possible.

Unlike the purchase of individual elements, the ZEISS stylus systems offer several advantages. The systems are delivered fully assembled and aligned so that the measurement can be started directly. ZEISS also offers the option of welding the joints so that the set angles cannot be adjusted. The systems can be archived and managed via a cloud, and the cloud enables direct communication with ZEISS designers. Stylus systems can be easily created and uniformly documented with the Stylus System Creator. The generated SSC files can be used for programming measuring programs with the CALYPSO Planner in the offline station.

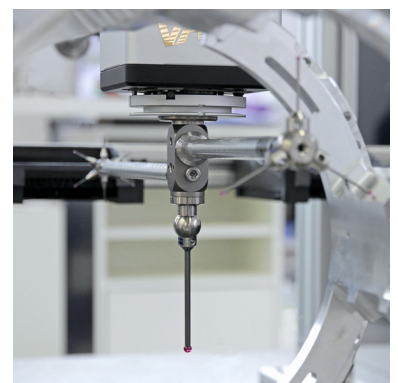



## CMM Styli

ZEISS styli - high-tech components for best performance



The stylus is the contact point of the machine with the component to be measured. It deflects the measurement data acquisition in the probe. The size and design of the stylus used is determined by the characteristic to be measured. Key parameters for styli are accuracy, rigidity and service life, which are primarily determined by the materials used and the manufacturing technology. The quality of the stylus is a decisive factor in the quality of the measuring result. The stylus service life is primarily determined by the type of shaft processing and the quality of the connection between the stylus tip and the shaft. High-end production processes and technologies make ZEISS the technology leader in the industry.

ZEISS styli are available in various versions. A large portfolio of standard styli for M2, M3, M3XXT or M5 threads is available. Different stylus tips made of different materials and different shaft designs can be purchased for these styli. Furthermore, there are also non-threaded styli and special styli for form, contour and surface measurements.



### The different shaft materials

The shaft material used and the shaft cross-section have the greatest influence on the stylus rigidity. For standard styli, ZEISS uses shafts made of a high-strength carbide. These represent a good compromise in terms of weight, deflection and thermal linear expansion. Styli with ThermoFit shafts are particularly light, stiff and have only a small linear expansion under the influence of heat. They are therefore particularly suitable for applications in the M3XXT range and for long styli with a large shaft thickness. ZEISS is the only supplier to use a high-strength Grade 5 titanium alloy for the adapters. This gives the adapters high rigidity and makes them significantly lighter than steel adapters and also makes them anti-magnetic and corrosion-resistant.

### The suitable sphere material

Usually a sphere is used as the stylus element. This sphere can be made of different materials and is suitable for different applications depending on the material. The standard are ruby spheres, but in combination with continuous scanning they can wear out or apply material to some surfaces. An alternative is silicon nitride, which has less material application when scanning aluminum, for example. Diamond coated or solid diamond spheres are especially suitable for scanning hard surfaces or soft aluminum alloys. Even sharp edges or single point scans with high load can be reliably performed. They have a very long durability, as they do not wear out and do not raise material.

Depending on the material of the stylus and the workpiece, wear or material deposits may occur. Therefore, check your styli regularly and remember to clean them with ZEISS stylus cleaning cloths or replace them if necessary. Would you like to know more about ZEISS styli? Then book our free stylus eLearning on the ZEISS eLearning platform.

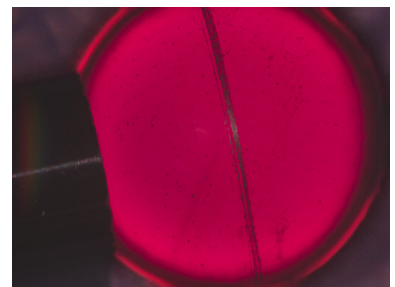

## M5

Styli with M5 thread are the ideal choice for the ZEISS VAST probe system.



Styli with M5 thread are ideally suited for systems using the ZEISS VAST active scanning sensor. Different stylus elements (sphere, disk, etc.) made of different materials are available. In addition to standard ruby and silicon nitride materials, extra-hard diamond styli are available. Carbon fiber shafts ensure particularly precise results when it comes to finding an optimum of stiffness, weight and thermal expansion. M5 styli can also be connected to other threaded systems with the appropriate connecting element. They can also be connected to other threaded systems with the appropriate connecting element.

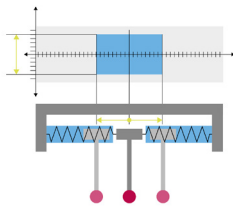

### ZEISS VAST Active Scanning Technology

Active scanning takes measurement to new heights: Software-controlled electromagnets apply a steady low force to the stylus whatever its size and orientation, enabling an expanded range of motion with no repositioning. Real-time deflection monitoring supports automatic adjustment. Enjoy maximum flexibility, greater speed, and the accuracy you need for future applications.

### ZEISS styli with a tungsten carbide shaft

ZEISS styli with a tungsten carbide shaft are produced in a unique manufacturing process. By using laser technologies, complex geometries such as the spherical caps for receiving the stylus tips or shaft reductions with extremely small diameters can be produced with great precision and with polished surface quality. In combination with the vacuum soldering process, styli can be manufactured with unique quality and stability. The advantage of this manufacturing method is the considerably longer tool time of ZEISS styli compared to conventional products on the market.

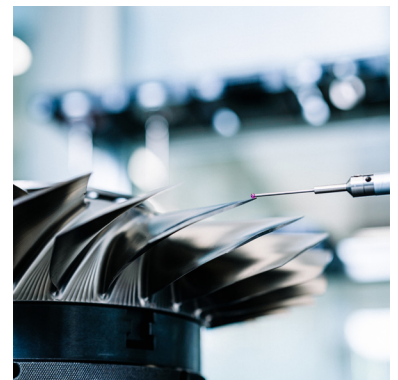

## Reference styli

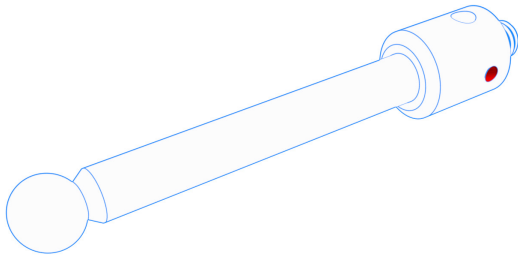

ZEISS reference styli are used to determine the position and geometry of the qualification test piece, usually a sphere. The software thus recognizes the ACTUAL data of the qualification test piece, which can then be compared with the calibrated NOMINAL data in order to detect machine errors. Afterwards, all following styli installed in stylus systems can be qualified in relation to them. Master styli are defined and labeled according to stability and accuracy in a readout procedure. Optimum results can be achieved during qualification.

### M5, Reference styli straight TC

Reference Styli are used to determine the position of calibration reference spheres. M5 thread for VAST active scanning sensors.

Connection Type: M5  
 Shaft Material: Tung. Carb.  
 Stylus Tip Geometry: Sphere  
 Stylus Tip Material: Ruby  
 Ø Body (DG): 11

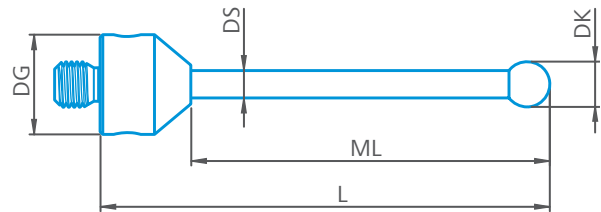

Article-No.	DK	L	ML	DS
600342-8023-010	8.00	63.50	50.50	6.00

# Standard styli

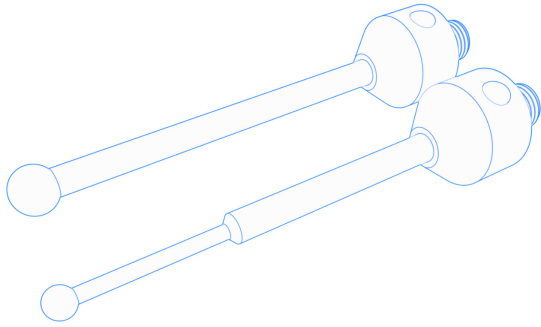

Spherical styli have the largest field of application because they have the same probing behavior in every direction. They are therefore suitable for all common measuring tasks such as measuring bores and surfaces. The larger the stylus sphere size, the larger the mechanical filter. This means that the profile of your workpiece is smoothed, which is often required in form measurement. The deviation from the ideal sphere shape is usually shown in Grade. ZEISS stylus tips come standard with Grade 5, but can also be offered with highly accurate roundness or diameters with a certificate for special requirements. Styli with a straight shaft are the most simple designed styli. The full shaft length can be used as measuring length. Stepped shaft has the advantage of a greater shaft thickness, which is reduced towards the measuring tip. This stepped shaft increases the stability of the shaft while maintaining the same length (depending on the sphere diameter). At the same time, however, the usable measuring length is reduced.

## M5, Styli straight, ruby sphere, tungsten carbide shaft

Standard Styli suitable for all common measuring tasks. M5 thread for VAST active scanning sensors.

- Connection Type: M5
- Shaft Material: Tung. Carb.
- Stylus Tip Geometry: Sphere
- Stylus Tip Material: Ruby
- Ø Body (DG): 11

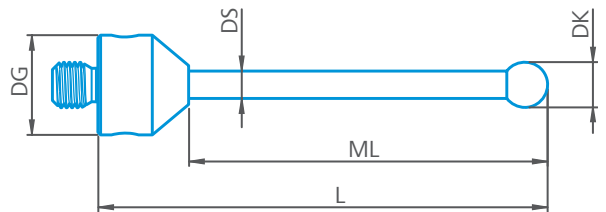

Article-No.	DK	L	ML	DS
626120-0284-000	0.50	20.00	4.00	0.40
626115-0060-021	0.60	21.00	10.50	0.40
000000-1120-407	0.60	32.00	4.50	0.40
626115-0070-020	0.70	20.00	10.00	0.50
626115-0081-022	0.80	22.00	12.00	0.60
626115-0082-025	0.80	25.00	15.00	0.80
626115-0080-030	0.80	30.00	20.00	0.60
626115-0081-035	0.80	35.00	25.00	0.60
626115-0091-030	0.90	30.00	20.00	0.60
626115-0101-015	1.00	15.00	5.00	0.50
626115-0102-015	1.00	15.00	5.00	0.80
626115-0100-018	1.00	18.00	8.00	0.70
626115-0101-020	1.00	20.00	10.00	0.80
626115-0102-020	1.00	20.00	10.00	0.70
626115-0101-021	1.00	20.50	10.50	0.80
626115-0100-021	1.00	21.00	12.00	0.70
626115-0102-022	1.00	22.00	12.00	0.80
626115-0103-025	1.00	25.00	15.00	0.80
626115-0106-025	1.00	25.00	15.00	0.50
000000-1039-074	1.00	29.00	20.00	0.70



Article-No.	DK	L	ML	DS
000000-1132-541	1.00	30.00	20.00	0.80
626115-0100-032	1.00	32.00	22.00	0.80
626115-0102-035	1.00	35.00	25.00	0.80
626115-0104-035	1.00	35.00	25.00	0.70
000000-1023-809	1.00	40.00	30.00	0.70
626115-0102-042	1.00	42.00	32.00	0.80
626115-0100-045	1.00	45.00	35.00	0.80
626115-0105-055	1.00	55.00	45.00	0.80
626115-0100-063	1.00	63.00	53.00	0.70
626115-0120-020	1.20	20.00	10.00	1.00
626115-0120-025	1.20	25.00	15.00	1.00
626115-0122-030	1.20	30.00	20.00	1.00
626115-0130-025	1.25	25.00	15.00	1.00
626115-0123-030	1.25	30.00	20.00	1.00
626115-0120-033	1.25	32.85	23.85	1.00
626115-0133-025	1.30	25.00	15.00	1.00
626115-0130-033	1.30	32.85	23.85	1.00
626105-5744-012	1.35	12.00	2.00	1.00
626105-5744-013	1.35	13.00	3.00	1.00
626105-5744-014	1.35	14.00	4.00	1.00
626105-5744-015	1.35	15.00	5.00	1.00
626105-5744-016	1.35	16.00	6.00	1.00
626105-5744-017	1.35	17.00	7.00	1.00
626105-5744-018	1.35	18.00	8.00	1.00
626105-5744-019	1.35	19.00	9.00	1.00
626105-5744-020	1.35	20.00	10.00	1.00
626105-5744-021	1.35	21.00	11.00	1.00
626105-5744-022	1.35	22.00	12.00	1.00
626105-5744-023	1.35	23.00	13.00	1.00
626105-5744-024	1.35	24.00	14.00	1.00
626105-5744-025	1.35	25.00	15.00	1.00
626105-5744-026	1.35	26.00	16.00	1.00
626105-5744-027	1.35	27.00	17.00	1.00
626105-5744-028	1.35	28.00	18.00	1.00
626105-5744-029	1.35	29.00	19.00	1.00
626115-0140-030	1.35	30.00	20.00	1.00
626105-5744-031	1.35	31.00	21.00	1.00
626105-5744-032	1.35	32.00	22.00	1.00
626115-0140-033	1.35	32.85	23.85	1.00
626105-5744-033	1.35	33.00	23.00	1.00
626105-5744-034	1.35	34.00	24.00	1.00
626105-5744-035	1.35	35.00	25.00	1.00
626105-5744-036	1.35	36.00	26.00	1.00
626115-0140-037	1.35	37.00	27.00	1.00
626105-5744-038	1.35	38.00	28.00	1.00
626105-5744-039	1.35	39.00	29.00	1.00
626105-5744-040	1.35	40.00	30.00	1.00
626105-5744-041	1.35	41.00	31.00	1.00
626115-0140-042	1.35	42.00	32.00	1.00
626105-5744-043	1.35	43.00	33.00	1.00
626105-5744-044	1.35	44.00	34.00	1.00



<b>Article-No.</b>	<b>DK</b>	<b>L</b>	<b>ML</b>	<b>DS</b>
626105-5744-045	1.35	45.00	35.00	1.00
626105-5744-046	1.35	46.00	36.00	1.00
626115-0140-046	1.35	46.00	35.00	1.00
626105-5744-047	1.35	47.00	37.00	1.00
626105-5744-048	1.35	48.00	38.00	1.00
626105-5744-049	1.35	49.00	39.00	1.00
626115-0142-050	1.35	50.00	40.00	1.00
626105-5744-051	1.35	51.00	41.00	1.00
626105-5744-052	1.35	52.00	42.00	1.00
626105-5744-053	1.35	53.00	43.00	1.00
626105-5744-054	1.35	54.00	44.00	1.00
626115-0140-055	1.35	55.00	45.00	1.00
626105-5744-056	1.35	56.00	46.00	1.00
626105-5744-057	1.35	57.00	47.00	1.00
626105-5744-058	1.35	58.00	48.00	1.00
626105-5744-059	1.35	59.00	49.00	1.00
626105-5744-060	1.35	60.00	50.00	1.00
626115-0140-062	1.35	62.00	50.00	1.00
626115-0140-020	1.40	20.00	10.00	1.00
626115-0141-025	1.40	25.00	15.00	1.00
626115-0141-033	1.40	33.00	23.00	1.00
626115-0144-033	1.40	33.00	24.00	1.00
626115-0140-035	1.40	35.00	25.00	1.00
626105-0144-013	1.50	13.00	3.00	1.00
626105-0144-014	1.50	14.00	4.00	1.00
626115-0150-015	1.50	15.00	5.00	1.00
626105-0144-016	1.50	16.00	6.00	1.00
626115-0150-017	1.50	17.00	7.00	1.00
626105-0144-018	1.50	18.00	8.00	1.00
626105-0144-019	1.50	19.00	9.00	1.00
626105-0144-020	1.50	20.00	10.00	1.00
626115-0150-020	1.50	20.00	9.00	1.00
626115-0150-021	1.50	20.75	11.75	1.00
626105-0144-021	1.50	21.00	11.00	1.00
626105-0144-022	1.50	22.00	12.00	1.00
626105-0144-023	1.50	23.00	13.00	1.00
626105-0144-024	1.50	24.00	14.00	1.00
626115-0150-025	1.50	25.00	15.00	1.00
000000-1263-182	1.50	26.00	17.00	1.00
626105-0144-026	1.50	26.00	16.00	1.00
626105-0144-027	1.50	27.00	17.00	1.00
626115-0151-028	1.50	28.00	18.00	1.00
626105-0144-029	1.50	29.00	19.00	1.00
626105-0150-029	1.50	29.00	20.00	1.00
626105-0144-030	1.50	30.00	20.00	1.00
626105-0144-031	1.50	31.00	21.00	1.00
626115-0153-032	1.50	32.00	22.00	1.00
626115-0150-033	1.50	33.00	24.00	1.00
626115-0152-033	1.50	33.00	23.00	1.00
626105-0144-034	1.50	34.00	24.00	1.00
626115-0151-035	1.50	35.00	25.00	1.00
626105-0144-036	1.50	36.00	26.00	1.00
626105-0144-037	1.50	37.00	27.00	1.00
626105-0144-038	1.50	38.00	28.00	1.00



Article-No.	DK	L	ML	DS
626105-0144-039	1.50	39.00	29.00	1.00
626115-0151-040	1.50	40.00	30.00	1.00
626120-0061-000	1.50	40.75	22.75	1.00
626105-0144-041	1.50	41.00	31.00	1.00
626105-0144-042	1.50	42.00	32.00	1.00
626105-0144-043	1.50	43.00	33.00	1.00
626115-0150-044	1.50	44.00	34.00	1.00
626115-0150-045	1.50	45.00	35.00	1.00
626105-0144-046	1.50	46.00	36.00	1.00
626115-0151-047	1.50	46.50	36.50	1.00
626105-0144-047	1.50	47.00	37.00	1.00
626105-0144-048	1.50	48.00	38.00	1.00
626105-0144-049	1.50	49.00	39.00	1.00
626115-0151-050	1.50	50.00	40.00	1.00
626105-0144-051	1.50	51.00	41.00	1.00
626105-0144-052	1.50	52.00	42.00	1.00
626105-0144-053	1.50	53.00	43.00	1.00
626105-0144-054	1.50	54.00	44.00	1.00
626105-0144-055	1.50	55.00	45.00	1.00
626105-0144-056	1.50	56.00	46.00	1.00
626105-0144-057	1.50	57.00	47.00	1.00
626115-0150-058	1.50	58.00	48.00	1.00
626105-0144-059	1.50	59.00	49.00	1.00
626115-0153-060	1.50	60.00	50.00	1.00
626105-0144-061	1.50	61.00	51.00	1.00
626115-0150-065	1.50	65.00	55.00	1.00
626115-0150-068	1.50	68.00	58.00	1.00
626115-0151-080	1.50	80.00	70.00	1.00
626115-0150-110	1.50	110.00	100.00	1.00
626115-0160-021	1.60	21.00	11.00	0.70
626115-0162-033	1.60	33.00	24.00	1.00
626115-0160-035	1.60	35.00	25.00	1.00
626115-0160-070	1.60	70.00	60.00	1.20
626115-0170-030	1.70	30.00	19.00	1.00
626115-0170-044	1.70	44.00	33.00	1.00
626115-0181-025	1.75	25.00	14.00	1.00
626115-0170-035	1.75	35.00	25.00	1.00
000000-1091-433	1.75	40.00	30.00	1.00
626115-0170-045	1.75	45.00	34.50	1.00
626115-0171-045	1.75	45.00	35.00	1.30
626115-0171-050	1.75	50.00	40.00	1.50
626115-0180-068	1.75	68.00	58.00	1.50
626115-0182-033	1.80	33.00	24.00	1.00
626115-0180-034	1.80	34.00	24.00	1.00
626115-0181-040	1.80	40.00	30.00	1.00
626115-0180-045	1.80	45.00	35.00	1.30
626115-0180-046	1.80	46.00	36.00	1.00
626115-0191-030	1.90	30.00	20.00	1.50
626105-0200-012	2.00	12.00	2.00	1.50
626105-0254-013	2.00	13.00	3.00	1.50
626105-0254-014	2.00	14.00	4.00	1.50





Article-No.	DK	L	ML	DS
626115-0200-014	2.00	14.00	5.00	1.00
626105-0254-015	2.00	15.00	5.00	1.50
626105-0200-015	2.00	15.00	5.00	1.00
626105-0254-016	2.00	16.00	6.00	1.50
626105-0254-017	2.00	17.00	7.00	1.50
626115-0200-017	2.00	17.00	7.00	1.00
626105-0254-018	2.00	18.00	8.00	1.50
626105-0254-019	2.00	19.00	9.00	1.50
626105-0254-020	2.00	20.00	10.00	1.50
626115-0200-020	2.00	20.00	10.00	1.00
626105-0254-021	2.00	21.00	11.00	1.50
626115-0201-021	2.00	21.00	11.00	1.00
626105-0254-022	2.00	22.00	12.00	1.50
626105-0254-023	2.00	23.00	13.00	1.50
626105-0254-024	2.00	24.00	14.00	1.50
000000-1043-427	2.00	25.00	15.00	1.50
626115-0200-025	2.00	25.00	15.00	1.00
626105-0254-026	2.00	26.00	16.00	1.50
626105-0254-027	2.00	27.00	17.00	1.50
626105-0254-028	2.00	28.00	18.00	1.50
626105-0254-029	2.00	29.00	19.00	1.50
626115-0200-030	2.00	30.00	20.00	1.50
626105-0254-031	2.00	31.00	21.00	1.50
626115-0201-031	2.00	31.00	21.00	1.00
626105-0254-032	2.00	32.00	22.00	1.50
626115-0200-033	2.00	33.00	23.00	1.50
626115-0204-034	2.00	33.00	23.00	1.00
626115-0200-034	2.00	33.50	24.50	1.50
626115-0201-033	2.00	33.50	23.50	1.50
626105-0200-034	2.00	33.50	23.50	1.00
626105-0254-034	2.00	34.00	24.00	1.50
626115-0205-035	2.00	35.00	25.00	1.50
626105-0254-036	2.00	36.00	26.00	1.50
626105-0254-037	2.00	37.00	27.00	1.50
000000-1031-215	2.00	38.00	28.00	1.50
626105-0254-039	2.00	39.00	29.00	1.50
626115-0204-040	2.00	40.00	30.00	1.50
626115-0200-040	2.00	40.00	31.00	1.00
626115-0201-040	2.00	40.00	30.00	1.00
626105-0254-041	2.00	41.00	31.00	1.50
626115-0200-041	2.00	41.00	31.00	1.00
626115-0202-042	2.00	42.00	32.00	1.50
626115-0203-042	2.00	42.00	32.00	1.00
000000-1171-980	2.00	43.00	33.00	1.50
626105-0254-044	2.00	44.00	34.00	1.50
626115-0200-044	2.00	44.00	35.00	1.00
626115-0202-045	2.00	45.00	35.00	1.50
626105-0200-045	2.00	45.00	35.00	1.00
626105-0254-046	2.00	46.00	36.00	1.50
626115-0200-046	2.00	46.00	36.00	1.00
626105-0254-047	2.00	47.00	37.00	1.50
626105-0254-049	2.00	49.00	39.00	1.50
000000-1033-336	2.00	50.00	40.00	1.00
626115-0200-050	2.00	50.00	40.00	1.50



Article-No.	DK	L	ML	DS
626105-0254-051	2.00	51.00	41.00	1.50
612030-9759-000	2.00	52.00	43.00	1.50
626105-0254-052	2.00	52.00	42.00	1.50
626105-0254-053	2.00	53.00	43.00	1.50
626105-0254-054	2.00	54.00	44.00	1.50
626115-0200-055	2.00	55.00	45.00	1.50
626105-0254-056	2.00	56.00	46.00	1.50
626105-0254-057	2.00	57.00	47.00	1.50
626115-0210-058	2.00	58.00	48.00	1.00
626115-0200-058	2.00	58.00	48.00	1.50
626115-0202-058	2.00	58.00	47.00	1.50
626105-0254-059	2.00	59.00	49.00	1.50
612030-9439-000	2.00	60.00	50.00	1.50
626115-0202-060	2.00	60.00	50.00	1.00
626105-0254-061	2.00	61.00	51.00	1.50
626115-0200-061	2.00	61.00	51.00	1.00
626105-0254-062	2.00	62.00	52.00	1.50
626105-0254-063	2.00	63.00	53.00	1.50
626105-0254-064	2.00	64.00	54.00	1.50
626105-0254-065	2.00	65.00	55.00	1.50
626115-0201-065	2.00	65.00	55.00	1.00
626115-0201-068	2.00	68.00	58.00	1.50
000000-1261-993	2.00	70.00	60.00	1.00
626105-0200-070	2.00	70.00	60.00	1.50
626115-0200-075	2.00	75.00	65.00	1.50
626115-0200-077	2.00	77.00	66.00	1.50
626115-0203-080	2.00	80.00	70.00	1.50
626115-0201-081	2.00	81.00	71.00	1.50
000000-1007-683	2.00	90.00	80.00	1.50
626115-0200-100	2.00	100.00	90.00	1.50
626115-0204-100	2.00	100.00	90.00	1.00
000000-1227-609	2.00	110.00	100.00	1.00
626115-0200-112	2.00	112.00	100.00	1.50
626115-0200-035	2.03	34.50	24.50	1.50
626115-0203-060	2.03	60.00	50.00	1.50
626115-0230-033	2.25	33.00	23.00	1.50
626115-0230-035	2.25	35.00	23.00	1.50
000000-1031-850	2.25	40.00	29.00	1.50
000000-1278-975	2.25	58.00	48.00	1.50
626115-0231-040	2.30	40.00	30.00	1.50
626115-0240-035	2.40	35.00	25.00	1.50
626115-0240-040	2.40	50.00	40.00	1.50
626115-0250-020	2.50	20.00	10.00	1.50
626115-0251-025	2.50	25.00	15.00	2.00
626115-0250-030	2.50	30.00	19.00	1.50
626115-0250-031	2.50	31.00	21.00	1.00
626120-0152-000	2.50	31.00	22.00	1.50
626115-0250-034	2.50	34.00	25.00	1.50
626115-0250-035	2.50	35.00	25.00	1.50
626115-0250-040	2.50	40.00	30.00	1.50
626120-0151-000	2.50	41.00	32.00	1.50



Article-No.	DK	L	ML	DS
626115-0250-045	2.50	45.00	35.00	1.00
626115-0252-045	2.50	45.00	35.00	1.50
000000-1032-513	2.50	50.00	40.00	2.00
626115-0250-050	2.50	50.00	40.00	1.50
626105-5855-056	2.50	56.00	46.00	1.50
000000-1301-283	2.50	58.00	48.00	1.50
626115-0251-058	2.50	58.00	48.00	2.00
626115-0250-060	2.50	60.00	50.00	1.50
626115-0250-070	2.50	70.00	60.00	1.50
626115-0251-075	2.50	75.00	65.00	1.50
000000-1238-920	2.50	80.00	70.00	2.00
626115-0250-085	2.50	85.00	75.00	1.50
000000-1227-653	2.50	90.00	80.00	1.50
626115-0250-100	2.50	100.00	90.00	1.50
000000-1227-652	2.50	110.00	100.00	1.50
626115-0250-115	2.50	115.00	105.00	1.50
000000-1192-206	2.50	120.00	110.00	2.00
626115-0250-129	2.50	129.00	120.00	1.50
626115-0250-160	2.50	160.00	150.00	2.00
626115-0271-025	2.70	25.00	15.00	1.50
626115-0270-035	2.70	35.00	25.00	1.50
626115-0281-034	2.80	34.00	25.00	1.50
626115-0290-040	2.90	40.00	30.00	2.00
626105-0304-013	3.00	13.00	3.00	2.00
626105-0304-014	3.00	14.00	4.00	2.00
626115-0301-015	3.00	15.00	5.00	2.00
626105-0304-016	3.00	16.00	6.00	2.00
626105-0304-017	3.00	17.00	7.00	2.00
626105-0304-018	3.00	18.00	8.00	2.00
626105-0304-019	3.00	19.00	9.00	2.00
626115-0300-020	3.00	20.00	10.00	1.50
626115-0303-020	3.00	20.00	10.00	2.00
626105-0304-021	3.00	21.00	11.00	2.00
626105-0304-022	3.00	22.00	12.00	2.00
626105-0304-023	3.00	23.00	13.00	2.00
626105-0304-024	3.00	24.00	14.00	2.00
626115-0300-025	3.00	25.00	15.00	1.50
602030-9010-000	3.00	25.00	15.00	2.00
626115-0300-026	3.00	26.00	16.00	2.00
626105-0300-026	3.00	26.00	16.00	1.50
626105-0304-027	3.00	27.00	17.00	2.00
626105-0304-028	3.00	28.00	18.00	2.00
626105-0304-029	3.00	29.00	19.00	2.00
626105-0300-030	3.00	29.50	19.50	1.50
626115-0300-030	3.00	30.00	20.00	1.50
626105-0304-030	3.00	30.00	20.00	2.00
626105-0304-031	3.00	31.00	21.00	2.00
626120-0147-000	3.00	31.50	22.50	2.00
626105-0304-032	3.00	32.00	22.00	2.00
626115-0304-033	3.00	33.00	23.00	2.00
600342-8020-000	3.00	33.50	23.50	2.00
626105-0304-034	3.00	34.00	24.00	2.00
626115-0302-035	3.00	35.00	25.00	2.00
626105-0304-036	3.00	36.00	26.00	2.00



Article-No.	DK	L	ML	DS
000000-1203-579	3.00	36.50	26.50	2.00
626115-0300-037	3.00	37.00	27.00	2.00
626115-0300-038	3.00	38.00	28.00	2.00
626105-0304-039	3.00	39.00	29.00	2.00
626115-0301-040	3.00	40.00	30.00	2.00
626105-0304-041	3.00	41.00	31.00	2.00
626115-0300-041	3.00	41.00	30.00	2.00
626120-0146-000	3.00	41.50	32.50	2.00
626115-0300-042	3.00	42.00	32.00	2.00
626115-0300-043	3.00	42.50	32.50	2.00
626105-0304-043	3.00	43.00	33.00	2.00
626105-0304-044	3.00	44.00	34.00	2.00
626105-0304-045	3.00	45.00	35.00	2.00
626115-0301-045	3.00	45.00	35.00	1.50
626105-0304-046	3.00	46.00	36.00	2.00
626115-0300-047	3.00	47.00	37.00	2.00
626105-0304-048	3.00	48.00	38.00	2.00
626105-0304-049	3.00	49.00	39.00	2.00
602030-9011-000	3.00	50.00	40.00	2.00
626105-0302-050	3.00	50.00	40.00	1.50
626105-0304-051	3.00	51.00	41.00	2.00
626120-0064-000	3.00	51.50	42.50	2.00
626105-0304-052	3.00	52.00	42.00	2.00
626105-0304-053	3.00	53.00	43.00	2.00
626105-0304-054	3.00	54.00	44.00	2.00
626115-0300-055	3.00	55.00	45.00	2.00
626105-0304-056	3.00	56.00	46.00	2.00
626105-0304-057	3.00	57.00	47.00	2.00
600342-8021-000	3.00	58.00	48.00	2.00
626115-0301-058	3.00	58.00	48.00	2.50
626115-0303-058	3.00	58.00	50.00	2.00
626105-0304-059	3.00	59.00	49.00	2.00
626105-0304-060	3.00	60.00	50.00	2.00
626105-0304-061	3.00	61.00	51.00	2.00
626115-0301-061	3.00	61.00	51.00	2.00
626105-0304-062	3.00	62.00	52.00	2.00
626105-0304-063	3.00	63.00	53.00	2.00
626115-0300-064	3.00	64.00	54.00	2.00
626115-0300-065	3.00	65.00	55.00	2.00
626115-0302-065	3.00	65.00	55.00	1.50
626105-0304-066	3.00	66.00	56.00	2.00
626115-0300-067	3.00	67.00	57.00	2.00
626115-0300-068	3.00	68.00	58.00	2.00
626105-0304-069	3.00	69.00	59.00	2.00
000000-1004-514	3.00	70.00	60.00	2.00
626115-0303-070	3.00	70.00	60.00	1.50
626115-0300-071	3.00	71.00	61.00	2.00
626105-0304-072	3.00	72.00	62.00	2.00
626105-0304-073	3.00	73.00	63.00	2.00
626105-0304-074	3.00	74.00	64.00	2.00
626115-0301-075	3.00	75.00	65.00	2.00



Article-No.	DK	L	ML	DS
626105-0304-076	3.00	76.00	66.00	2.00
626105-0304-077	3.00	77.00	67.00	2.00
626115-0301-078	3.00	78.00	68.00	2.00
626105-0304-079	3.00	79.00	69.00	2.00
626115-0300-080	3.00	80.00	70.00	2.00
626115-0303-080	3.00	80.00	70.00	2.50
626105-0304-081	3.00	81.00	71.00	2.00
626105-0304-082	3.00	82.00	72.00	2.00
626105-0304-083	3.00	83.00	73.00	2.00
626105-0304-084	3.00	84.00	74.00	2.00
626115-0300-085	3.00	85.00	75.00	2.00
626115-0302-085	3.00	85.00	75.00	1.50
626105-0304-086	3.00	86.00	76.00	2.00
626115-0300-087	3.00	87.00	77.00	2.00
626105-0304-088	3.00	88.00	78.00	2.00
626105-0304-089	3.00	89.00	79.00	2.00
626115-0300-090	3.00	90.00	80.00	2.00
626115-0302-090	3.00	90.00	80.00	1.50
626115-0305-090	3.00	90.00	80.00	2.50
626105-0304-091	3.00	91.00	81.00	2.00
626105-0304-092	3.00	92.00	82.00	2.00
626105-0304-093	3.00	93.00	83.00	2.00
626105-0304-094	3.00	94.00	84.00	2.00
626115-0300-095	3.00	95.00	85.00	2.00
626105-0304-096	3.00	96.00	86.00	2.00
626105-0304-097	3.00	97.00	87.00	2.00
626105-0304-098	3.00	98.00	88.00	2.00
626105-0304-099	3.00	99.00	89.00	2.00
626115-0300-100	3.00	100.00	90.00	2.00
626115-0300-101	3.00	101.00	90.00	2.00
626115-0301-105	3.00	105.00	94.00	2.00
626115-0301-110	3.00	110.00	100.00	2.00
626115-0306-110	3.00	110.00	100.00	2.50
626115-0300-115	3.00	115.00	104.00	2.00
626115-0300-120	3.00	120.00	109.00	2.00
626115-0303-120	3.00	120.00	110.00	2.50
626115-0300-128	3.00	128.00	118.00	2.00
626115-0300-129	3.00	129.00	120.00	2.00
626115-0301-130	3.00	130.00	119.00	2.00
626115-0302-145	3.00	145.00	135.00	2.00
626115-0300-155	3.00	155.00	145.00	2.00
626115-0300-200	3.00	200.00	190.00	2.50
626115-0330-034	3.25	33.50	23.50	2.00
626115-0350-020	3.50	20.00	10.00	2.00
626115-0350-025	3.50	25.00	15.00	2.00
626115-0350-030	3.50	30.00	20.00	2.00
626115-0350-034	3.50	33.50	23.50	2.00
626115-0352-035	3.50	35.00	25.00	2.00
626115-0350-040	3.50	40.00	30.00	2.00
626115-0351-042	3.50	42.00	32.00	2.00
626115-0350-045	3.50	45.00	35.00	2.00
626115-0351-045	3.50	45.00	35.00	1.50
626115-0350-050	3.50	50.00	40.00	2.50
626115-0351-050	3.50	50.00	40.00	2.00



Article-No.	DK	L	ML	DS
626115-0350-051	3.50	51.00	40.00	2.00
626115-0351-058	3.50	58.00	48.00	3.00
626115-0352-058	3.50	58.00	48.00	2.00
626115-0350-060	3.50	60.00	49.00	2.00
626115-0352-060	3.50	60.00	50.00	1.50
000000-1275-301	3.50	62.00	52.00	2.00
626115-0350-064	3.50	63.50	53.50	2.00
626115-0350-068	3.50	68.00	58.00	2.00
626115-0350-070	3.50	70.00	59.00	2.00
626115-0350-075	3.50	75.00	65.00	2.50
626115-0355-075	3.50	75.00	65.00	1.50
626115-0350-076	3.50	75.50	65.50	2.50
626115-0355-080	3.50	80.00	70.00	2.00
626115-0350-085	3.50	85.00	75.00	2.00
626115-0351-085	3.50	85.00	75.00	2.50
626115-0350-091	3.50	91.00	81.00	2.00
626115-0351-092	3.50	92.00	82.00	3.00
626115-0350-095	3.50	95.00	81.00	2.50
626115-0351-095	3.50	95.00	85.00	2.00
626115-0350-100	3.50	100.00	89.00	2.00
626115-0351-100	3.50	100.00	89.00	2.50
626115-0350-110	3.50	110.00	100.00	2.00
626115-0350-120	3.50	120.00	110.00	2.50
000000-1301-292	3.50	123.00	111.00	2.50
626115-0350-125	3.50	125.00	115.00	2.50
000000-1114-353	3.50	130.00	119.00	2.00
626115-0350-145	3.50	145.00	135.00	2.50
626115-0350-160	3.50	160.00	147.00	3.00
626115-0350-225	3.50	225.00	200.00	3.00
626115-0371-040	3.70	40.00	30.00	2.00
626115-0380-058	3.81	58.00	48.00	2.00
626105-0464-014	4.00	14.00	4.00	2.50
626105-0404-014	4.00	14.00	4.00	2.00
626105-0474-014	4.00	14.00	4.00	3.00
626105-0464-015	4.00	15.00	5.00	2.50
626115-0400-015	4.00	15.00	5.00	2.00
626105-0474-015	4.00	15.00	5.00	3.00
626105-0404-016	4.00	16.00	6.00	2.00
626105-0464-016	4.00	16.00	6.00	2.50
626105-0474-016	4.00	16.00	6.00	3.00
626105-0464-017	4.00	17.00	7.00	2.50
626105-0404-017	4.00	17.00	7.00	2.00
626105-0474-017	4.00	17.00	7.00	3.00
626105-0464-018	4.00	18.00	8.00	2.50
626105-0404-018	4.00	18.00	8.00	2.00
626105-0474-018	4.00	18.00	8.00	3.00
626105-0464-019	4.00	19.00	9.00	2.50
626105-0474-019	4.00	19.00	9.00	3.00
626105-0404-019	4.00	19.00	9.00	2.00
626115-0401-020	4.00	20.00	10.00	2.00
626105-0464-020	4.00	20.00	10.00	2.50



Article-No.	DK	L	ML	DS
626105-0474-020	4.00	20.00	10.00	3.00
626105-0404-021	4.00	21.00	11.00	2.00
626105-0464-021	4.00	21.00	11.00	2.50
626105-0474-021	4.00	21.00	11.00	3.00
626115-0400-022	4.00	22.00	12.00	2.00
626105-0464-022	4.00	22.00	12.00	2.50
626105-0474-022	4.00	22.00	12.00	3.00
626105-0464-023	4.00	23.00	13.00	2.50
626105-0404-023	4.00	23.00	13.00	2.00
626105-0474-023	4.00	23.00	13.00	3.00
626105-0404-024	4.00	24.00	14.00	2.00
626105-0464-024	4.00	24.00	14.00	2.50
626105-0474-024	4.00	24.00	14.00	3.00
626105-0464-025	4.00	25.00	15.00	2.50
626115-0400-025	4.00	25.00	15.00	2.00
626105-0474-025	4.00	25.00	15.00	3.00
626105-0464-026	4.00	26.00	16.00	2.50
000000-1131-800	4.00	26.00	16.00	2.00
626105-0474-026	4.00	26.00	16.00	3.00
626105-0404-027	4.00	27.00	17.00	2.00
626105-0464-027	4.00	27.00	17.00	2.50
626105-0474-027	4.00	27.00	17.00	3.00
626105-0404-028	4.00	28.00	18.00	2.00
626105-0464-028	4.00	28.00	18.00	2.50
626105-0474-028	4.00	28.00	18.00	3.00
626105-0474-029	4.00	29.00	19.00	3.00
626105-0404-029	4.00	29.00	19.00	2.00
626105-0464-029	4.00	29.00	19.00	2.50
626105-0464-030	4.00	30.00	20.00	2.50
626105-0474-030	4.00	30.00	20.00	3.00
626115-0400-030	4.00	30.00	20.00	2.00
626105-0404-031	4.00	31.00	21.00	2.00
626105-0464-031	4.00	31.00	21.00	2.50
626105-0474-031	4.00	31.00	21.00	3.00
626115-0400-032	4.00	32.00	22.00	2.00
626105-0464-032	4.00	32.00	22.00	2.50
626105-0474-032	4.00	32.00	22.00	3.00
626105-0404-033	4.00	33.00	23.00	2.00
626105-0474-033	4.00	33.00	23.00	3.00
626105-0464-033	4.00	33.00	23.00	2.50
600342-8025-000	4.00	33.50	23.50	2.00
626105-0464-034	4.00	34.00	24.00	2.50
000000-1058-071	4.00	34.00	24.00	2.00
626105-0474-034	4.00	34.00	24.00	3.00
626105-0474-035	4.00	35.00	25.00	3.00
626115-0400-035	4.00	35.00	25.00	2.00
626105-0464-035	4.00	35.00	25.00	2.50
626105-0404-036	4.00	36.00	26.00	2.00
626105-0464-036	4.00	36.00	26.00	2.50
626105-0474-036	4.00	36.00	26.00	3.00
626105-0404-037	4.00	37.00	27.00	2.00
626105-0464-037	4.00	37.00	27.00	2.50
626105-0474-037	4.00	37.00	27.00	3.00
626105-0474-038	4.00	38.00	28.00	3.00





Article-No.	DK	L	ML	DS
626105-0404-038	4.00	38.00	28.00	2.00
626105-0464-038	4.00	38.00	28.00	2.50
626105-0404-039	4.00	39.00	29.00	2.00
626105-0474-039	4.00	39.00	29.00	3.00
626105-0464-039	4.00	39.00	29.00	2.50
626105-0474-040	4.00	40.00	30.00	3.00
626115-0400-040	4.00	40.00	30.00	2.00
626115-0402-040	4.00	40.00	30.00	1.50
626105-0464-040	4.00	40.00	30.00	2.50
626105-0404-041	4.00	41.00	31.00	2.00
626105-0474-041	4.00	41.00	31.00	3.00
626115-0401-041	4.00	41.00	31.00	2.50
626105-0404-042	4.00	42.00	32.00	2.00
626105-0464-042	4.00	42.00	32.00	2.50
626105-0474-042	4.00	42.00	32.00	3.00
626105-0464-043	4.00	43.00	33.00	2.50
626105-0404-043	4.00	43.00	33.00	2.00
626105-0474-043	4.00	43.00	33.00	3.00
626105-0404-044	4.00	44.00	34.00	2.00
626105-0464-044	4.00	44.00	34.00	2.50
626105-0474-044	4.00	44.00	34.00	3.00
626105-0464-045	4.00	45.00	35.00	2.50
626105-0404-045	4.00	45.00	35.00	2.00
626105-0474-045	4.00	45.00	35.00	3.00
626115-0400-046	4.00	46.00	36.00	2.00
626105-0464-046	4.00	46.00	36.00	2.50
626105-0474-046	4.00	46.00	36.00	3.00
626105-0404-047	4.00	47.00	37.00	2.00
626105-0464-047	4.00	47.00	37.00	2.50
626105-0474-047	4.00	47.00	37.00	3.00
626105-0404-048	4.00	48.00	38.00	2.00
626105-0464-048	4.00	48.00	38.00	2.50
626105-0474-048	4.00	48.00	38.00	3.00
626105-0404-049	4.00	49.00	39.00	2.00
626105-0464-049	4.00	49.00	39.00	2.50
626105-0474-049	4.00	49.00	39.00	3.00
626105-0474-050	4.00	50.00	40.00	3.00
626115-0400-050	4.00	50.00	40.00	2.50
626115-0402-050	4.00	50.00	40.00	2.00
626115-0404-050	4.00	50.00	40.00	1.50
626105-0404-051	4.00	51.00	41.00	2.00
626105-0464-051	4.00	51.00	41.00	2.50
626105-0474-051	4.00	51.00	41.00	3.00
626105-0404-052	4.00	52.00	42.00	2.00
626105-0464-052	4.00	52.00	42.00	2.50
626105-0474-052	4.00	52.00	42.00	3.00
626105-0464-053	4.00	53.00	43.00	2.50
626105-0474-053	4.00	53.00	43.00	3.00
626115-0402-053	4.00	53.00	43.00	2.00
626105-0404-054	4.00	54.00	44.00	2.00
626105-0464-054	4.00	54.00	44.00	2.50



Article-No.	DK	L	ML	DS
626105-0474-054	4.00	54.00	44.00	3.00
626105-0404-055	4.00	55.00	45.00	2.00
626105-0464-055	4.00	55.00	45.00	2.50
626115-0400-055	4.00	55.00	45.00	3.00
626105-0464-056	4.00	56.00	46.00	2.50
626105-0404-056	4.00	56.00	46.00	2.00
626105-0474-056	4.00	56.00	46.00	3.00
626105-0404-057	4.00	57.00	47.00	2.00
626105-0464-057	4.00	57.00	47.00	2.50
626105-0474-057	4.00	57.00	47.00	3.00
626105-0464-058	4.00	58.00	48.00	2.50
626105-0474-058	4.00	58.00	48.00	3.00
626115-0401-058	4.00	58.00	48.00	2.00
626105-0464-059	4.00	59.00	49.00	2.50
626115-0400-059	4.00	59.00	49.00	2.00
626105-0474-059	4.00	59.00	49.00	3.00
000000-1003-073	4.00	60.00	50.00	2.00
626105-0474-060	4.00	60.00	50.00	3.00
626115-0405-060	4.00	60.00	50.00	2.50
626115-0406-060	4.00	60.00	50.00	1.20
626105-0404-061	4.00	61.00	51.00	2.00
626105-0464-061	4.00	61.00	51.00	2.50
626105-0474-061	4.00	61.00	51.00	3.00
626105-0406-062	4.00	61.50	51.50	2.00
626105-0404-062	4.00	62.00	52.00	2.00
626105-0464-062	4.00	62.00	52.00	2.50
626105-0474-062	4.00	62.00	52.00	3.00
626105-0404-063	4.00	63.00	53.00	2.00
626105-0464-063	4.00	63.00	53.00	2.50
626105-0474-063	4.00	63.00	53.00	3.00
602030-9012-000	4.00	64.00	54.00	2.00
626105-0474-064	4.00	64.00	54.00	3.00
626115-0400-064	4.00	64.00	54.00	2.50
626105-0404-065	4.00	65.00	55.00	2.00
626105-0464-065	4.00	65.00	55.00	2.50
626105-0474-065	4.00	65.00	55.00	3.00
626105-0464-066	4.00	66.00	56.00	2.50
626105-0474-066	4.00	66.00	56.00	3.00
626105-0404-066	4.00	66.00	56.00	2.00
626105-0464-067	4.00	67.00	57.00	2.50
626105-0404-067	4.00	67.00	57.00	2.00
626105-0474-067	4.00	67.00	57.00	3.00
626105-0464-068	4.00	68.00	58.00	2.50
626105-0404-068	4.00	68.00	58.00	2.00
626105-0474-068	4.00	68.00	58.00	3.00
626105-0464-069	4.00	69.00	59.00	2.50
626105-0404-069	4.00	69.00	59.00	2.00
626105-0474-069	4.00	69.00	59.00	3.00
626105-0474-070	4.00	70.00	60.00	3.00
626115-0400-070	4.00	70.00	60.00	2.00
626115-0403-070	4.00	70.00	60.00	2.50
626105-0404-071	4.00	71.00	61.00	2.00
626105-0464-071	4.00	71.00	61.00	2.50
626105-0474-071	4.00	71.00	61.00	3.00



Article-No.	DK	L	ML	DS
626105-0404-072	4.00	72.00	62.00	2.00
626105-0464-072	4.00	72.00	62.00	2.50
626105-0474-072	4.00	72.00	62.00	3.00
626105-0464-073	4.00	73.00	63.00	2.50
626105-0404-073	4.00	73.00	63.00	2.00
626105-0474-073	4.00	73.00	63.00	3.00
626105-0404-074	4.00	74.00	64.00	2.00
626105-0464-074	4.00	74.00	64.00	2.50
626105-0474-074	4.00	74.00	64.00	3.00
626105-0474-075	4.00	75.00	65.00	3.00
626115-0400-075	4.00	75.00	65.00	2.50
626115-0401-075	4.00	75.00	65.00	2.00
626105-0464-076	4.00	76.00	66.00	2.50
626105-0404-076	4.00	76.00	66.00	2.00
626105-0474-076	4.00	76.00	66.00	3.00
626105-0404-077	4.00	77.00	67.00	2.00
626105-0464-077	4.00	77.00	67.00	2.50
626105-0474-077	4.00	77.00	67.00	3.00
626105-0464-078	4.00	78.00	68.00	2.50
626105-0474-078	4.00	78.00	68.00	3.00
626115-0400-078	4.00	78.00	68.00	2.00
626105-0464-079	4.00	79.00	69.00	2.50
626105-0404-079	4.00	79.00	69.00	2.00
626105-0474-079	4.00	79.00	69.00	3.00
626105-0464-080	4.00	80.00	70.00	2.50
626115-0400-080	4.00	80.00	70.00	3.00
626115-0401-080	4.00	80.00	70.00	2.00
626105-0474-081	4.00	81.00	71.00	3.00
626105-0404-081	4.00	81.00	71.00	2.00
626105-0464-081	4.00	81.00	71.00	2.50
626115-0400-082	4.00	82.00	72.00	2.50
626105-0404-082	4.00	82.00	72.00	2.00
626105-0474-082	4.00	82.00	72.00	3.00
626105-0464-083	4.00	83.00	73.00	2.50
626105-0404-083	4.00	83.00	73.00	2.00
626105-0474-083	4.00	83.00	73.00	3.00
626105-0404-084	4.00	84.00	74.00	2.00
626105-0464-084	4.00	84.00	74.00	2.50
626105-0474-084	4.00	84.00	74.00	3.00
000000-1182-146	4.00	85.00	75.00	2.50
626105-0474-085	4.00	85.00	75.00	3.00
626115-0401-085	4.00	85.00	75.00	2.00
626105-0464-086	4.00	86.00	76.00	2.50
626115-0400-086	4.00	86.00	76.00	2.00
626105-0474-086	4.00	86.00	76.00	3.00
626105-0464-087	4.00	87.00	77.00	2.50
626105-0404-087	4.00	87.00	77.00	2.00
626105-0474-087	4.00	87.00	77.00	3.00
626105-0464-088	4.00	88.00	78.00	2.50
626105-0404-088	4.00	88.00	78.00	2.00
626105-0474-088	4.00	88.00	78.00	3.00



Article-No.	DK	L	ML	DS
626105-0404-089	4.00	89.00	79.00	2.00
626105-0474-089	4.00	89.00	79.00	3.00
626105-0464-089	4.00	89.00	79.00	2.50
626105-0464-090	4.00	90.00	80.00	2.50
626105-0474-090	4.00	90.00	80.00	3.00
626115-0401-090	4.00	90.00	80.00	1.50
626115-0403-090	4.00	90.00	80.00	2.00
626105-0464-091	4.00	91.00	81.00	2.50
626105-0404-091	4.00	91.00	81.00	2.00
626105-0474-091	4.00	91.00	81.00	3.00
626105-0404-092	4.00	92.00	82.00	2.00
626105-0474-092	4.00	92.00	82.00	3.00
626115-0400-092	4.00	92.00	82.00	2.50
626115-0400-093	4.00	93.00	83.00	2.00
626105-0464-093	4.00	93.00	83.00	2.50
626105-0474-093	4.00	93.00	83.00	3.00
626105-0464-094	4.00	94.00	84.00	2.50
626105-0404-094	4.00	94.00	84.00	2.00
626105-0474-094	4.00	94.00	84.00	3.00
626105-0464-095	4.00	95.00	85.00	2.50
626105-0404-095	4.00	95.00	85.00	2.00
626105-0474-095	4.00	95.00	85.00	3.00
626105-0464-096	4.00	96.00	86.00	2.50
626105-0404-096	4.00	96.00	86.00	2.00
626105-0474-096	4.00	96.00	86.00	3.00
626105-0464-097	4.00	97.00	87.00	2.50
626105-0404-097	4.00	97.00	87.00	2.00
626105-0474-097	4.00	97.00	87.00	3.00
626105-0404-098	4.00	98.00	88.00	2.00
626105-0464-098	4.00	98.00	88.00	2.50
626105-0474-098	4.00	98.00	88.00	3.00
626105-0464-099	4.00	99.00	89.00	2.50
626105-0474-099	4.00	99.00	89.00	3.00
626105-0404-099	4.00	99.00	89.00	2.00
000000-1065-411	4.00	100.00	90.00	2.00
626115-0400-100	4.00	100.00	90.00	3.00
626115-0401-100	4.00	100.00	90.00	2.50
626105-0474-100	4.00	100.00	90.00	3.00
626115-0400-101	4.00	101.00	91.00	2.00
626105-0474-101	4.00	101.00	91.00	3.00
626105-0464-101	4.00	101.00	91.00	2.50
626115-0400-102	4.00	102.00	92.00	2.50
626105-0474-102	4.00	102.00	92.00	3.00
626105-0404-102	4.00	102.00	92.00	2.00
626115-0400-103	4.00	103.00	93.00	3.00
626105-0404-103	4.00	103.00	93.00	2.00
626105-0464-103	4.00	103.00	93.00	2.50
626105-0474-104	4.00	104.00	94.00	3.00
626105-0404-104	4.00	104.00	94.00	2.00
626105-0464-104	4.00	104.00	94.00	2.50
626105-0474-105	4.00	105.00	95.00	3.00
626105-0404-105	4.00	105.00	95.00	2.00
626115-0400-105	4.00	105.00	95.00	2.50
626115-0400-106	4.00	106.00	96.00	2.00



Article-No.	DK	L	ML	DS
626105-0464-106	4.00	106.00	96.00	2.50
626105-0474-106	4.00	106.00	96.00	3.00
626105-0404-107	4.00	107.00	97.00	2.00
626105-0464-107	4.00	107.00	97.00	2.50
626105-0474-107	4.00	107.00	97.00	3.00
626105-0464-108	4.00	108.00	98.00	2.50
626105-0474-108	4.00	108.00	98.00	3.00
626115-0400-108	4.00	108.00	98.00	2.00
626105-0404-109	4.00	109.00	99.00	2.00
626105-0464-109	4.00	109.00	99.00	2.50
626105-0474-109	4.00	109.00	99.00	3.00
626105-0464-110	4.00	110.00	100.00	2.50
626115-0401-110	4.00	110.00	100.00	2.00
626115-0404-110	4.00	110.00	100.00	3.00
626105-0474-111	4.00	111.00	101.00	3.00
626105-0404-111	4.00	111.00	101.00	2.00
626105-0464-111	4.00	111.00	101.00	2.50
626105-0404-112	4.00	112.00	102.00	2.00
626115-0400-112	4.00	112.00	102.00	2.50
626105-0474-112	4.00	112.00	102.00	3.00
626105-0404-113	4.00	113.00	103.00	2.00
626105-0464-113	4.00	113.00	103.00	2.50
626105-0474-113	4.00	113.00	103.00	3.00
626105-0474-114	4.00	114.00	104.00	3.00
626105-0404-114	4.00	114.00	104.00	2.00
626105-0464-114	4.00	114.00	104.00	2.50
626115-0400-114	4.00	114.00	104.00	3.00
626105-0404-115	4.00	115.00	105.00	2.00
626115-0400-115	4.00	115.00	105.00	2.50
626105-0474-115	4.00	115.00	105.00	3.00
626105-0404-116	4.00	116.00	106.00	2.00
626105-0464-116	4.00	116.00	106.00	2.50
626105-0474-116	4.00	116.00	106.00	3.00
626105-0464-117	4.00	117.00	107.00	2.50
626105-0474-117	4.00	117.00	107.00	3.00
626105-0404-117	4.00	117.00	107.00	2.00
626105-0474-118	4.00	118.00	108.00	3.00
626105-0404-118	4.00	118.00	108.00	2.00
626105-0464-118	4.00	118.00	108.00	2.50
626105-0474-119	4.00	119.00	109.00	3.00
626105-0404-119	4.00	119.00	109.00	2.00
626105-0464-119	4.00	119.00	109.00	2.50
626115-0402-120	4.00	120.00	110.00	3.00
626115-0403-120	4.00	120.00	110.00	2.00
626115-0404-120	4.00	120.00	110.00	2.50
626105-0474-121	4.00	121.00	111.00	3.00
626105-0404-121	4.00	121.00	111.00	2.00
626105-0464-121	4.00	121.00	111.00	2.50
626105-0464-122	4.00	122.00	112.00	2.50
626105-0474-122	4.00	122.00	112.00	3.00
626105-0404-122	4.00	122.00	112.00	2.00



Article-No.	DK	L	ML	DS
626105-0474-123	4.00	123.00	113.00	3.00
626105-0464-123	4.00	123.00	113.00	2.50
626115-0400-123	4.00	123.00	113.00	2.00
626105-0474-124	4.00	124.00	114.00	3.00
626105-0404-124	4.00	124.00	114.00	2.00
626105-0464-124	4.00	124.00	114.00	2.50
626115-0400-125	4.00	125.00	115.00	3.00
626105-0404-125	4.00	125.00	115.00	2.00
626115-0401-125	4.00	125.00	115.00	2.50
626105-0404-126	4.00	126.00	116.00	2.00
626105-0464-126	4.00	126.00	116.00	2.50
626105-0474-126	4.00	126.00	116.00	3.00
626105-0404-127	4.00	127.00	117.00	2.00
626105-0464-127	4.00	127.00	117.00	2.50
626105-0474-127	4.00	127.00	117.00	3.00
626105-0404-128	4.00	128.00	118.00	2.00
626105-0464-128	4.00	128.00	118.00	2.50
626105-0474-128	4.00	128.00	118.00	3.00
626105-0404-129	4.00	129.00	119.00	2.00
626105-0464-129	4.00	129.00	119.00	2.50
626105-0474-129	4.00	129.00	119.00	3.00
626115-0401-130	4.00	130.00	120.00	2.00
626105-0464-130	4.00	130.00	120.00	2.50
626115-0400-130	4.00	130.00	120.00	3.00
626105-0464-131	4.00	131.00	121.00	2.50
626105-0474-131	4.00	131.00	121.00	3.00
626105-0474-132	4.00	132.00	122.00	3.00
626105-0464-132	4.00	132.00	122.00	2.50
626105-0474-133	4.00	133.00	123.00	3.00
626105-0464-133	4.00	133.00	123.00	2.50
626105-0474-134	4.00	134.00	124.00	3.00
626105-0464-134	4.00	134.00	124.00	2.50
626105-0464-135	4.00	135.00	125.00	2.50
626115-0401-135	4.00	135.00	125.00	3.00
626105-0474-136	4.00	136.00	126.00	3.00
626105-0474-137	4.00	137.00	127.00	3.00
626105-0474-138	4.00	138.00	128.00	3.00
626105-0474-139	4.00	139.00	129.00	3.00
626105-0474-140	4.00	140.00	130.00	3.00
626105-0474-141	4.00	141.00	131.00	3.00
626105-0474-142	4.00	142.00	132.00	3.00
626105-0474-143	4.00	143.00	133.00	3.00
626105-0474-144	4.00	144.00	134.00	3.00
626105-0474-145	4.00	145.00	135.00	3.00
626105-0474-146	4.00	146.00	136.00	3.00
626105-0474-147	4.00	147.00	137.00	3.00
626105-0474-148	4.00	148.00	138.00	3.00
626105-0474-149	4.00	149.00	139.00	3.00
626115-0400-150	4.00	150.00	140.00	3.00
626105-0474-151	4.00	151.00	141.00	3.00
626105-0474-152	4.00	152.00	142.00	3.00
626105-0474-153	4.00	153.00	143.00	3.00
626105-0474-154	4.00	154.00	144.00	3.00
626105-0474-155	4.00	155.00	145.00	3.00



Article-No.	DK	L	ML	DS
626115-0400-160	4.00	160.00	147.00	3.00
626115-0450-020	4.50	20.00	10.00	1.00
626115-0451-030	4.50	30.00	20.00	1.00
000000-1305-273	4.50	33.50	23.50	2.00
626115-0450-036	4.50	36.00	26.00	2.00
000000-1016-524	4.50	40.00	30.00	2.00
000000-1031-854	4.50	50.00	40.00	2.00
626115-0450-050	4.50	50.00	40.00	2.50
626115-0451-050	4.50	50.00	40.00	3.00
612030-9661-000	4.50	53.00	43.00	3.50
626115-0450-058	4.50	58.00	48.00	2.00
626115-0450-065	4.50	64.50	54.50	2.00
626115-0451-065	4.50	65.00	55.00	3.00
626115-0450-070	4.50	70.00	50.00	3.50
626115-0451-075	4.50	75.00	65.00	3.50
626115-0450-090	4.50	90.00	80.00	2.00
626115-0450-100	4.50	100.00	88.00	2.50
626115-0450-117	4.50	117.00	107.00	3.00
626115-0450-130	4.50	130.00	120.00	3.00
626115-0450-150	4.50	150.00	140.00	2.50
626115-0450-195	4.50	195.00	180.00	3.50
626105-0504-015	5.00	15.00	5.00	2.00
626105-0584-015	5.00	15.00	5.00	4.00
626115-0500-015	5.00	15.00	5.00	3.50
626105-0504-016	5.00	16.00	6.00	2.00
626105-0584-016	5.00	16.00	6.00	4.00
626105-0504-017	5.00	17.00	7.00	2.00
626105-0584-017	5.00	17.00	7.00	4.00
626115-0500-018	5.00	18.00	8.00	2.00
626105-0584-018	5.00	18.00	8.00	4.00
626105-0504-019	5.00	19.00	9.00	2.00
626105-0584-019	5.00	19.00	9.00	4.00
626105-0504-020	5.00	20.00	10.00	2.00
626105-0584-020	5.00	20.00	10.00	4.00
626115-0505-020	5.00	20.00	10.00	3.50
626105-0504-021	5.00	21.00	11.00	2.00
626105-0584-021	5.00	21.00	11.00	4.00
626105-0504-022	5.00	22.00	12.00	2.00
626105-0584-022	5.00	22.00	12.00	4.00
626105-0504-023	5.00	23.00	13.00	2.00
626105-0584-023	5.00	23.00	13.00	4.00
626105-0504-024	5.00	24.00	14.00	2.00
626105-0584-024	5.00	24.00	14.00	4.00
626105-0504-025	5.00	25.00	15.00	2.00
626105-0584-025	5.00	25.00	15.00	4.00
626115-0500-025	5.00	25.00	15.00	3.50
626105-0514-026	5.00	26.00	16.00	3.50
626105-0504-026	5.00	26.00	16.00	2.00
626105-0584-026	5.00	26.00	16.00	4.00
626115-0500-027	5.00	27.00	17.00	4.00
626105-0504-027	5.00	27.00	17.00	2.00





Article-No.	DK	L	ML	DS
626105-0514-027	5.00	27.00	17.00	3.50
626105-0504-028	5.00	28.00	18.00	2.00
626105-0514-028	5.00	28.00	18.00	3.50
626105-0584-028	5.00	28.00	18.00	4.00
626105-0514-029	5.00	29.00	19.00	3.50
626105-0504-029	5.00	29.00	19.00	2.00
626105-0584-029	5.00	29.00	19.00	4.00
000000-1043-423	5.00	30.00	20.00	2.00
000000-1301-568	5.00	30.00	20.00	3.50
626115-0500-030	5.00	30.00	20.00	2.50
626105-0584-030	5.00	30.00	20.00	4.00
626105-0504-031	5.00	31.00	21.00	2.00
626105-0514-031	5.00	31.00	21.00	3.50
626105-0584-031	5.00	31.00	21.00	4.00
626105-0584-032	5.00	32.00	22.00	4.00
626105-0504-032	5.00	32.00	22.00	2.00
626105-0514-032	5.00	32.00	22.00	3.50
626115-0501-033	5.00	32.50	22.50	3.00
626115-0500-033	5.00	33.00	23.00	3.50
626105-0504-033	5.00	33.00	23.00	2.00
626105-0500-033	5.00	33.00	23.00	3.00
626105-0584-033	5.00	33.00	23.00	4.00
626105-0504-034	5.00	34.00	24.00	2.00
626105-0584-034	5.00	34.00	24.00	4.00
626115-0501-035	5.00	35.00	25.00	2.00
626115-0502-035	5.00	35.00	23.00	2.50
626105-0514-035	5.00	35.00	25.00	3.50
626105-0584-035	5.00	35.00	25.00	4.00
626105-0504-036	5.00	36.00	26.00	2.00
626105-0514-036	5.00	36.00	26.00	3.50
626105-0584-036	5.00	36.00	26.00	4.00
626105-0504-037	5.00	37.00	27.00	2.00
626105-0514-037	5.00	37.00	27.00	3.50
626105-0584-037	5.00	37.00	27.00	4.00
626105-0504-038	5.00	38.00	28.00	2.00
626105-0584-038	5.00	38.00	28.00	4.00
626105-0514-038	5.00	38.00	28.00	3.50
626105-0504-039	5.00	39.00	29.00	2.00
626105-0514-039	5.00	39.00	29.00	3.50
626105-0584-039	5.00	39.00	29.00	4.00
626115-0500-040	5.00	40.00	30.00	3.50
626105-0504-040	5.00	40.00	30.00	2.00
626105-0584-040	5.00	40.00	30.00	4.00
000000-1043-425	5.00	41.00	31.00	2.00
626105-0514-041	5.00	41.00	31.00	3.50
626105-0584-041	5.00	41.00	31.00	4.00
626105-0504-042	5.00	42.00	32.00	2.00
626105-0514-042	5.00	42.00	32.00	3.50
626105-0584-042	5.00	42.00	32.00	4.00
626105-0504-043	5.00	43.00	33.00	2.00
626105-0514-043	5.00	43.00	33.00	3.50
626105-0584-043	5.00	43.00	33.00	4.00
626105-0504-044	5.00	44.00	34.00	2.00
626105-0514-044	5.00	44.00	34.00	3.50



Article-No.	DK	L	ML	DS
626105-0584-044	5.00	44.00	34.00	4.00
626115-0500-045	5.00	45.00	35.00	3.50
626105-0504-045	5.00	45.00	35.00	2.00
626105-0584-045	5.00	45.00	35.00	4.00
626105-0514-046	5.00	46.00	36.00	3.50
626105-0504-046	5.00	46.00	36.00	2.00
626105-0584-046	5.00	46.00	36.00	4.00
626105-0514-047	5.00	47.00	37.00	3.50
626105-0504-047	5.00	47.00	37.00	2.00
626105-0584-047	5.00	47.00	37.00	4.00
626105-0584-048	5.00	48.00	38.00	4.00
626105-0504-048	5.00	48.00	38.00	2.00
626105-0514-048	5.00	48.00	38.00	3.50
626105-0504-049	5.00	49.00	39.00	2.00
626105-0514-049	5.00	49.00	39.00	3.50
626105-0584-049	5.00	49.00	39.00	4.00
602030-9013-000	5.00	50.00	40.00	3.50
626105-0584-050	5.00	50.00	40.00	4.00
626115-0500-050	5.00	50.00	40.00	2.50
626115-0503-050	5.00	50.00	40.00	2.00
626115-5000-055	5.00	50.00	40.00	3.50
626105-0504-051	5.00	51.00	41.00	2.00
626105-0514-051	5.00	51.00	41.00	3.50
626105-0584-051	5.00	51.00	41.00	4.00
626105-0514-052	5.00	52.00	42.00	3.50
626105-0504-052	5.00	52.00	42.00	2.00
626105-0584-052	5.00	52.00	42.00	4.00
600342-8022-000	5.00	53.00	43.00	3.50
626105-0504-053	5.00	53.00	43.00	2.00
626105-0584-053	5.00	53.00	43.00	4.00
626105-0514-054	5.00	54.00	44.00	3.50
626105-0504-054	5.00	54.00	44.00	2.00
626105-0584-054	5.00	54.00	44.00	4.00
626105-0514-055	5.00	55.00	45.00	3.50
626105-0504-055	5.00	55.00	45.00	2.00
626105-0584-055	5.00	55.00	45.00	4.00
626105-0504-056	5.00	56.00	46.00	2.00
626105-0514-056	5.00	56.00	46.00	3.50
626105-0584-056	5.00	56.00	46.00	4.00
626105-0504-057	5.00	57.00	47.00	2.00
626105-0514-057	5.00	57.00	47.00	3.50
626105-0584-057	5.00	57.00	47.00	4.00
626105-0504-058	5.00	58.00	48.00	2.00
626105-0584-058	5.00	58.00	48.00	4.00
626105-0514-058	5.00	58.00	48.00	3.50
626105-0504-059	5.00	59.00	49.00	2.00
626105-0514-059	5.00	59.00	49.00	3.50
626105-0584-059	5.00	59.00	49.00	4.00
626105-0514-060	5.00	60.00	50.00	3.50
626115-0500-060	5.00	60.00	50.00	2.00
626115-0501-060	5.00	60.00	50.00	4.00



Article-No.	DK	L	ML	DS
626115-0500-061	5.00	61.00	51.00	3.50
626105-0504-061	5.00	61.00	51.00	2.00
626105-0584-061	5.00	61.00	51.00	4.00
000000-1301-293	5.00	62.00	52.00	3.50
626105-0504-062	5.00	62.00	52.00	2.00
626105-0584-062	5.00	62.00	52.00	4.00
626115-0500-063	5.00	62.50	52.50	3.00
626105-0504-063	5.00	63.00	53.00	2.00
626105-0514-063	5.00	63.00	53.00	3.50
626105-0584-063	5.00	63.00	53.00	4.00
626105-0514-064	5.00	64.00	54.00	3.50
626105-0504-064	5.00	64.00	54.00	2.00
626105-0584-064	5.00	64.00	54.00	4.00
626105-0504-065	5.00	65.00	55.00	2.00
626115-0500-065	5.00	65.00	55.00	3.50
626105-0584-065	5.00	65.00	55.00	4.00
626105-0504-066	5.00	66.00	56.00	2.00
626105-0514-066	5.00	66.00	56.00	3.50
626105-0584-066	5.00	66.00	56.00	4.00
626105-0504-067	5.00	67.00	57.00	2.00
626105-0514-067	5.00	67.00	57.00	3.50
626105-0584-067	5.00	67.00	57.00	4.00
626105-0504-068	5.00	68.00	58.00	2.00
626105-0514-068	5.00	68.00	58.00	3.50
626105-0584-068	5.00	68.00	58.00	4.00
626105-0504-069	5.00	69.00	59.00	2.00
626105-0514-069	5.00	69.00	59.00	3.50
626105-0584-069	5.00	69.00	59.00	4.00
626105-0514-070	5.00	70.00	60.00	3.50
626115-0501-070	5.00	70.00	60.00	2.00
626105-0584-070	5.00	70.00	60.00	4.00
626105-0504-071	5.00	71.00	61.00	2.00
626105-0514-071	5.00	71.00	61.00	3.50
626105-0584-071	5.00	71.00	61.00	4.00
626105-0504-072	5.00	72.00	62.00	2.00
626105-0514-072	5.00	72.00	62.00	3.50
626105-0584-072	5.00	72.00	62.00	4.00
626105-0514-073	5.00	73.00	63.00	3.50
626105-0584-073	5.00	73.00	63.00	4.00
626105-0504-073	5.00	73.00	63.00	2.00
626105-0514-074	5.00	74.00	64.00	3.50
626105-0584-074	5.00	74.00	64.00	4.00
626105-0504-074	5.00	74.00	64.00	2.00
626115-0500-074	5.00	74.00	64.00	3.00
602030-9015-000	5.00	75.00	65.00	3.50
626105-0504-075	5.00	75.00	65.00	2.00
626105-0584-075	5.00	75.00	65.00	4.00
626115-0502-075	5.00	75.00	65.00	3.00
626115-0504-075	5.00	75.00	65.00	2.50
000000-1017-996	5.00	75.00	57.00	3.00
626105-0504-076	5.00	76.00	66.00	2.00
626105-0514-076	5.00	76.00	66.00	3.50
626105-0584-076	5.00	76.00	66.00	4.00
626105-0504-077	5.00	77.00	67.00	2.00



Article-No.	DK	L	ML	DS
626105-0514-077	5.00	77.00	67.00	3.50
626105-0584-077	5.00	77.00	67.00	4.00
626105-0514-078	5.00	78.00	68.00	3.50
626105-0504-078	5.00	78.00	68.00	2.00
626105-0584-078	5.00	78.00	68.00	4.00
626105-0514-079	5.00	79.00	69.00	3.50
626105-0504-079	5.00	79.00	69.00	2.00
626105-0584-079	5.00	79.00	69.00	4.00
626105-0504-080	5.00	80.00	70.00	2.00
626115-0500-080	5.00	80.00	70.00	4.00
626115-0502-080	5.00	80.00	70.00	3.50
626105-0504-081	5.00	81.00	71.00	2.00
626105-0514-081	5.00	81.00	71.00	3.50
626105-0584-081	5.00	81.00	71.00	4.00
626105-0504-082	5.00	82.00	72.00	2.00
626105-0514-082	5.00	82.00	72.00	3.50
626105-0584-082	5.00	82.00	72.00	4.00
626105-0504-083	5.00	83.00	73.00	2.00
626105-0584-083	5.00	83.00	73.00	4.00
626115-0500-083	5.00	83.00	73.00	3.50
626105-0514-084	5.00	84.00	74.00	3.50
626105-0504-084	5.00	84.00	74.00	2.00
626105-0584-084	5.00	84.00	74.00	4.00
626105-0514-085	5.00	85.00	75.00	3.50
626115-0500-085	5.00	85.00	75.00	2.00
626105-0584-085	5.00	85.00	75.00	4.00
626105-0514-086	5.00	86.00	76.00	3.50
626105-0504-086	5.00	86.00	76.00	2.00
626105-0584-086	5.00	86.00	76.00	4.00
626105-0504-087	5.00	87.00	77.00	2.00
626105-0514-087	5.00	87.00	77.00	3.50
626105-0584-087	5.00	87.00	77.00	4.00
626105-0584-088	5.00	88.00	78.00	4.00
626105-0504-088	5.00	88.00	78.00	2.00
626105-0514-088	5.00	88.00	78.00	3.50
626105-0584-089	5.00	89.00	79.00	4.00
626105-0504-089	5.00	89.00	79.00	2.00
626105-0514-089	5.00	89.00	79.00	3.50
626105-0504-090	5.00	90.00	80.00	2.00
626105-0514-090	5.00	90.00	80.00	3.50
626115-0500-090	5.00	90.00	80.00	3.00
626105-0584-090	5.00	90.00	80.00	4.00
626105-0504-091	5.00	91.00	81.00	2.00
626105-0514-091	5.00	91.00	81.00	3.50
626105-0584-091	5.00	91.00	81.00	4.00
626105-0504-092	5.00	92.00	82.00	2.00
626105-0514-092	5.00	92.00	82.00	3.50
626105-0584-092	5.00	92.00	82.00	4.00
626105-0504-093	5.00	93.00	83.00	2.00
626105-0514-093	5.00	93.00	83.00	3.50
626105-0584-093	5.00	93.00	83.00	4.00



Article-No.	DK	L	ML	DS
626105-0504-094	5.00	94.00	84.00	2.00
626105-0514-094	5.00	94.00	84.00	3.50
626105-0584-094	5.00	94.00	84.00	4.00
626105-0504-095	5.00	95.00	85.00	2.00
626105-0514-095	5.00	95.00	85.00	3.50
626105-0584-095	5.00	95.00	85.00	4.00
626105-0514-096	5.00	96.00	86.00	3.50
626105-0584-096	5.00	96.00	86.00	4.00
626105-0504-096	5.00	96.00	86.00	2.00
626115-0500-097	5.00	97.00	87.00	3.50
626105-0504-097	5.00	97.00	87.00	2.00
626105-0584-097	5.00	97.00	87.00	4.00
626105-0504-098	5.00	98.00	88.00	2.00
626105-0514-098	5.00	98.00	88.00	3.50
626105-0584-098	5.00	98.00	88.00	4.00
626105-0504-099	5.00	99.00	89.00	2.00
626105-0514-099	5.00	99.00	89.00	3.50
626105-0584-099	5.00	99.00	89.00	4.00
626105-0584-100	5.00	100.00	90.00	4.00
626115-0500-100	5.00	100.00	90.00	3.50
626115-0504-100	5.00	100.00	90.00	2.00
626115-5000-243	5.00	100.00	90.00	3.50
626105-0504-101	5.00	101.00	91.00	2.00
626105-0584-101	5.00	101.00	91.00	4.00
626105-0514-101	5.00	101.00	91.00	3.50
626105-0514-102	5.00	102.00	92.00	3.50
626105-0584-102	5.00	102.00	92.00	4.00
626105-0504-102	5.00	102.00	92.00	2.00
626105-0514-103	5.00	103.00	93.00	3.50
626105-0584-103	5.00	103.00	93.00	4.00
626105-0504-103	5.00	103.00	93.00	2.00
626105-0504-104	5.00	104.00	94.00	2.00
626105-0514-104	5.00	104.00	94.00	3.50
626105-0584-104	5.00	104.00	94.00	4.00
626105-0584-105	5.00	105.00	95.00	4.00
626115-0500-105	5.00	105.00	95.00	3.50
626105-0504-105	5.00	105.00	95.00	2.00
626105-0504-106	5.00	106.00	96.00	2.00
626105-0514-106	5.00	106.00	96.00	3.50
626105-0584-106	5.00	106.00	96.00	4.00
626105-0504-107	5.00	107.00	97.00	2.00
626105-0514-107	5.00	107.00	97.00	3.50
626105-0584-107	5.00	107.00	97.00	4.00
626105-0504-108	5.00	108.00	98.00	2.00
626105-0514-108	5.00	108.00	98.00	3.50
626105-0584-108	5.00	108.00	98.00	4.00
626105-0584-109	5.00	109.00	99.00	4.00
626115-0500-109	5.00	109.00	99.00	3.50
626105-0504-109	5.00	109.00	99.00	2.00
626105-0504-110	5.00	110.00	100.00	2.00
626105-0584-110	5.00	110.00	100.00	4.00
626115-0500-110	5.00	110.00	100.00	3.50
626115-0502-110	5.00	110.00	100.00	3.00
626105-0584-111	5.00	111.00	101.00	4.00



Article-No.	DK	L	ML	DS
626115-0500-111	5.00	111.00	101.00	3.50
626105-0504-111	5.00	111.00	101.00	2.00
626105-0504-112	5.00	112.00	102.00	2.00
626105-0514-112	5.00	112.00	102.00	3.50
626105-0584-112	5.00	112.00	102.00	4.00
626105-0504-113	5.00	113.00	103.00	2.00
626115-0500-113	5.00	113.00	103.00	3.50
626105-0584-113	5.00	113.00	103.00	4.00
626105-0504-114	5.00	114.00	104.00	2.00
626105-0514-114	5.00	114.00	104.00	3.50
626105-0584-114	5.00	114.00	104.00	4.00
626105-0504-115	5.00	115.00	105.00	2.00
626105-0584-115	5.00	115.00	105.00	4.00
626115-0500-115	5.00	115.00	105.00	3.50
626105-0574-115	5.00	115.00	105.00	3.00
626105-0504-116	5.00	116.00	106.00	2.00
626105-0514-116	5.00	116.00	106.00	3.50
626105-0584-116	5.00	116.00	106.00	4.00
626105-0584-117	5.00	117.00	107.00	4.00
626105-0504-117	5.00	117.00	107.00	2.00
626105-0514-117	5.00	117.00	107.00	3.50
626105-0504-118	5.00	118.00	108.00	2.00
626105-0514-118	5.00	118.00	108.00	3.50
626105-0584-118	5.00	118.00	108.00	4.00
626105-0584-119	5.00	119.00	109.00	4.00
626105-0504-119	5.00	119.00	109.00	2.00
626105-0514-119	5.00	119.00	109.00	3.50
626105-0504-120	5.00	120.00	110.00	2.00
626105-0584-120	5.00	120.00	110.00	4.00
626115-0501-120	5.00	120.00	110.00	3.50
626115-0504-120	5.00	120.00	110.00	2.50
626105-0574-120	5.00	120.00	110.00	3.00
626105-0584-121	5.00	121.00	111.00	4.00
626105-0504-121	5.00	121.00	111.00	2.00
626105-0514-121	5.00	121.00	111.00	3.50
626105-0584-122	5.00	122.00	112.00	4.00
626105-0504-122	5.00	122.00	112.00	2.00
626105-0514-122	5.00	122.00	112.00	3.50
626105-0504-123	5.00	123.00	113.00	2.00
626105-0514-123	5.00	123.00	113.00	3.50
626105-0584-123	5.00	123.00	113.00	4.00
626105-0504-124	5.00	124.00	114.00	2.00
626105-0514-124	5.00	124.00	114.00	3.50
626115-0500-124	5.00	124.00	114.00	3.00
626105-0584-124	5.00	124.00	114.00	4.00
626105-0504-125	5.00	125.00	115.00	2.00
626105-0584-125	5.00	125.00	115.00	4.00
626115-0500-125	5.00	125.00	112.00	3.50
626115-0502-125	5.00	125.00	115.00	3.50
626105-0584-126	5.00	126.00	116.00	4.00
626105-0504-126	5.00	126.00	116.00	2.00



Article-No.	DK	L	ML	DS
626105-0514-126	5.00	126.00	116.00	3.50
626105-0504-127	5.00	127.00	117.00	2.00
626105-0514-127	5.00	127.00	117.00	3.50
626105-0584-127	5.00	127.00	117.00	4.00
626105-0584-128	5.00	128.00	118.00	4.00
626105-0504-128	5.00	128.00	118.00	2.00
626105-0514-128	5.00	128.00	118.00	3.50
626105-0584-129	5.00	129.00	119.00	4.00
626105-0504-129	5.00	129.00	119.00	2.00
626105-0514-129	5.00	129.00	119.00	3.50
000000-1026-524	5.00	130.00	120.00	3.50
626105-0504-130	5.00	130.00	120.00	2.00
626105-0584-130	5.00	130.00	120.00	4.00
626105-0584-131	5.00	131.00	121.00	4.00
626115-0500-131	5.00	131.00	121.00	3.50
626105-0514-132	5.00	132.00	122.00	3.50
626105-0584-132	5.00	132.00	122.00	4.00
626105-0514-133	5.00	133.00	123.00	3.50
626105-0584-133	5.00	133.00	123.00	4.00
626115-0500-133	5.00	133.00	123.00	3.00
626105-0514-134	5.00	134.00	124.00	3.50
626105-0584-134	5.00	134.00	124.00	4.00
000000-1078-285	5.00	135.00	125.00	3.50
626105-0584-135	5.00	135.00	125.00	4.00
626105-0574-135	5.00	135.00	125.00	3.00
626105-0584-136	5.00	136.00	126.00	4.00
626105-0514-136	5.00	136.00	126.00	3.50
626105-0584-137	5.00	137.00	127.00	4.00
626105-0514-137	5.00	137.00	127.00	3.50
626105-0584-138	5.00	138.00	128.00	4.00
626115-0500-138	5.00	138.00	128.00	3.50
626105-0584-139	5.00	139.00	129.00	4.00
626105-0514-139	5.00	139.00	129.00	3.50
626105-0584-140	5.00	140.00	130.00	4.00
626115-0500-140	5.00	140.00	130.00	3.50
626115-0503-140	5.00	140.00	130.00	3.00
626105-0514-141	5.00	141.00	131.00	3.50
626105-0584-141	5.00	141.00	131.00	4.00
626105-0514-142	5.00	142.00	132.00	3.50
626105-0584-142	5.00	142.00	132.00	4.00
626105-0514-143	5.00	143.00	133.00	3.50
626105-0584-143	5.00	143.00	133.00	4.00
626105-0514-144	5.00	144.00	134.00	3.50
626105-0584-144	5.00	144.00	134.00	4.00
626105-0584-145	5.00	145.00	135.00	4.00
626115-0500-145	5.00	145.00	135.00	3.50
626105-0514-146	5.00	146.00	136.00	3.50
626105-0514-147	5.00	147.00	137.00	3.50
626105-0514-148	5.00	148.00	138.00	3.50
626105-0514-149	5.00	149.00	139.00	3.50
626115-0500-150	5.00	150.00	140.00	3.50
626115-0502-150	5.00	150.00	140.00	3.00
626105-0514-151	5.00	151.00	141.00	3.50
626105-0514-152	5.00	152.00	142.00	3.50



Article-No.	DK	L	ML	DS
626105-0514-153	5.00	153.00	143.00	3.50
626115-0500-154	5.00	154.00	144.00	3.50
626105-0514-155	5.00	155.00	145.00	3.50
626105-0514-156	5.00	156.00	146.00	3.50
626105-0514-157	5.00	157.00	147.00	3.50
626105-0514-158	5.00	158.00	148.00	3.50
626105-0514-159	5.00	159.00	149.00	3.50
626115-0502-160	5.00	160.00	150.00	3.50
626115-0500-160	5.00	160.00	150.00	3.00
626105-0514-161	5.00	161.00	151.00	3.50
626105-0514-162	5.00	162.00	152.00	3.50
626105-0514-163	5.00	163.00	153.00	3.50
626105-0514-164	5.00	164.00	154.00	3.50
626105-0514-165	5.00	165.00	155.00	3.50
626105-0514-166	5.00	166.00	156.00	3.50
626105-0514-167	5.00	167.00	157.00	3.50
626105-0514-168	5.00	168.00	158.00	3.50
626105-0514-169	5.00	169.00	159.00	3.50
626105-0514-170	5.00	170.00	160.00	3.50
626105-0514-171	5.00	171.00	161.00	3.50
626105-0514-172	5.00	172.00	162.00	3.50
626105-0514-173	5.00	173.00	163.00	3.50
626105-0514-174	5.00	174.00	164.00	3.50
626105-0514-175	5.00	175.00	165.00	3.50
626105-0514-176	5.00	176.00	166.00	3.50
626105-0514-177	5.00	177.00	167.00	3.50
626105-0514-178	5.00	178.00	168.00	3.50
626105-0514-179	5.00	179.00	169.00	3.50
626115-0500-180	5.00	180.00	170.00	3.50
626105-0514-181	5.00	181.00	171.00	3.50
626105-0514-182	5.00	182.00	172.00	3.50
626105-0514-183	5.00	183.00	173.00	3.50
626105-0514-184	5.00	184.00	174.00	3.50
626115-0500-185	5.00	185.00	175.00	3.50
626105-0514-186	5.00	186.00	176.00	3.50
626105-0514-187	5.00	187.00	177.00	3.50
626105-0514-188	5.00	188.00	178.00	3.50
626105-0514-189	5.00	189.00	179.00	3.50
626115-0500-215	5.00	215.00	200.00	3.50
626115-0500-220	5.00	220.00	205.00	4.00
626115-0500-250	5.00	250.00	237.00	5.00
626115-0500-255	5.00	255.00	240.00	3.50
626115-0551-030	5.50	30.00	20.00	2.00
626115-0550-034	5.50	33.50	23.00	3.50
626115-0550-050	5.50	50.00	40.00	3.50
626115-0550-065	5.50	65.00	55.00	3.50
626115-0550-075	5.50	75.00	65.00	3.50
626115-0550-100	5.50	100.00	90.00	3.50
626115-0550-265	5.50	265.00	255.00	4.00
626115-0600-020	6.00	20.00	9.00	2.00
626115-0600-025	6.00	25.00	15.00	3.50





Article-No.	DK	L	ML	DS
626105-0614-026	6.00	26.00	16.00	3.50
626105-0614-027	6.00	27.00	17.00	3.50
626105-0614-028	6.00	28.00	18.00	3.50
626105-0614-029	6.00	29.00	19.00	3.50
626105-0614-030	6.00	30.00	20.00	3.50
626105-0614-031	6.00	31.00	21.00	3.50
626105-0614-032	6.00	32.00	22.00	3.50
626105-0614-033	6.00	33.00	23.00	3.50
626115-0600-033	6.00	33.00	21.00	3.00
626105-0614-034	6.00	34.00	24.00	3.50
626105-0614-035	6.00	35.00	25.00	3.50
626115-0600-035	6.00	35.00	25.00	2.00
626105-0614-036	6.00	36.00	26.00	3.50
626105-0614-037	6.00	37.00	27.00	3.50
626105-0614-038	6.00	38.00	28.00	3.50
626115-0600-038	6.00	38.00	28.00	2.00
626105-0614-039	6.00	39.00	29.00	3.50
626105-0614-040	6.00	40.00	30.00	3.50
626115-0600-040	6.00	40.00	30.00	2.00
626105-0614-041	6.00	41.00	31.00	3.50
626105-0614-042	6.00	42.00	32.00	3.50
626105-0614-043	6.00	43.00	33.00	3.50
626105-0614-044	6.00	44.00	34.00	3.50
626105-0614-045	6.00	45.00	35.00	3.50
626115-0600-046	6.00	46.00	36.00	3.50
626105-0614-047	6.00	47.00	37.00	3.50
626105-0614-048	6.00	48.00	38.00	3.50
626105-0614-049	6.00	49.00	39.00	3.50
626115-0602-050	6.00	50.00	40.00	2.00
626115-0605-050	6.00	50.00	40.00	3.50
626105-0614-051	6.00	51.00	41.00	3.50
626105-0614-052	6.00	52.00	42.00	3.50
626105-0614-053	6.00	53.00	43.00	3.50
600342-8026-000	6.00	54.00	44.00	3.50
626115-5000-440	6.00	54.00	44.00	3.50
626115-0600-055	6.00	55.00	43.00	2.50
626115-0602-055	6.00	55.00	45.00	3.50
626105-0614-056	6.00	56.00	46.00	3.50
626115-0600-056	6.00	56.00	45.00	2.00
626105-0614-057	6.00	57.00	47.00	3.50
626105-0614-058	6.00	58.00	48.00	3.50
626115-0600-058	6.00	58.00	48.00	4.00
626105-0614-059	6.00	59.00	49.00	3.50
626115-0605-060	6.00	60.00	50.00	3.50
626105-0614-061	6.00	61.00	51.00	3.50
626105-0614-062	6.00	62.00	52.00	3.50
626105-0614-063	6.00	63.00	53.00	3.50
626105-0614-064	6.00	64.00	54.00	3.50
626105-0614-065	6.00	65.00	55.00	3.50
626105-0614-066	6.00	66.00	56.00	3.50
626105-0614-067	6.00	67.00	57.00	3.50
626115-0600-068	6.00	68.00	58.00	3.50
626105-0614-069	6.00	69.00	59.00	3.50
626105-0614-070	6.00	70.00	60.00	3.50



Article-No.	DK	L	ML	DS
626115-0600-070	6.00	70.00	60.00	4.50
626115-0602-070	6.00	70.00	60.00	3.00
626105-0614-071	6.00	71.00	61.00	3.50
626105-0614-072	6.00	72.00	62.00	3.50
626105-0614-073	6.00	73.00	63.00	3.50
626105-0614-074	6.00	74.00	64.00	3.50
000000-1019-136	6.00	75.00	65.00	3.00
000000-1162-262	6.00	75.00	65.00	3.50
626115-0600-075	6.00	75.00	65.00	4.00
626105-0614-076	6.00	76.00	66.00	3.50
626105-0614-077	6.00	77.00	67.00	3.50
626105-0614-078	6.00	78.00	68.00	3.50
626105-0614-079	6.00	79.00	69.00	3.50
626105-0614-080	6.00	80.00	70.00	3.50
626105-0614-081	6.00	81.00	71.00	3.50
626105-0614-082	6.00	82.00	72.00	3.50
626105-0614-083	6.00	83.00	73.00	3.50
626105-0614-084	6.00	84.00	74.00	3.50
626105-0614-085	6.00	85.00	75.00	3.50
626105-0614-086	6.00	86.00	76.00	3.50
626105-0614-087	6.00	87.00	77.00	3.50
626115-0600-088	6.00	88.00	78.00	3.50
626105-0614-089	6.00	89.00	79.00	3.50
626105-0614-090	6.00	90.00	80.00	3.50
626115-0601-090	6.00	90.00	80.00	3.00
626105-0614-091	6.00	91.00	81.00	3.50
626105-0614-092	6.00	92.00	82.00	3.50
626105-0614-093	6.00	93.00	83.00	3.50
626105-0614-094	6.00	94.00	84.00	3.50
626105-0614-095	6.00	95.00	85.00	3.50
626105-0614-096	6.00	96.00	86.00	3.50
626105-0614-097	6.00	97.00	87.00	3.50
626115-0600-098	6.00	98.00	88.00	3.50
626105-0614-099	6.00	99.00	89.00	3.50
626115-0600-100	6.00	100.00	90.00	3.50
626105-0614-101	6.00	101.00	91.00	3.50
626105-0614-102	6.00	102.00	92.00	3.50
626115-0600-103	6.00	103.00	93.00	3.50
000000-1125-979	6.00	103.00	93.00	4.00
626105-0614-104	6.00	104.00	94.00	3.50
626105-0614-105	6.00	105.00	95.00	3.50
626105-0614-106	6.00	106.00	96.00	3.50
626105-0614-107	6.00	107.00	97.00	3.50
626105-0614-108	6.00	108.00	98.00	3.50
626105-0614-109	6.00	109.00	99.00	3.50
626115-0600-110	6.00	110.00	100.00	4.00
626115-0601-110	6.00	110.00	100.00	3.50
626105-0614-111	6.00	111.00	101.00	3.50
626105-0614-112	6.00	112.00	102.00	3.50
626105-0614-113	6.00	113.00	103.00	3.50
626115-0600-114	6.00	114.00	104.00	3.50



Article-No.	DK	L	ML	DS
000000-1279-313	6.00	114.50	104.50	4.00
626115-0600-115	6.00	115.00	105.00	3.50
626105-0614-116	6.00	116.00	106.00	3.50
626105-0614-117	6.00	117.00	107.00	3.50
626105-0614-118	6.00	118.00	108.00	3.50
626105-0614-119	6.00	119.00	109.00	3.50
626105-0614-120	6.00	120.00	110.00	3.50
626105-0614-121	6.00	121.00	111.00	3.50
626105-0614-122	6.00	122.00	112.00	3.50
626115-0600-122	6.00	122.00	112.00	4.00
626105-0614-123	6.00	123.00	113.00	3.50
626105-0614-124	6.00	124.00	114.00	3.50
626115-0600-125	6.00	125.00	115.00	4.00
626115-0601-125	6.00	125.00	115.00	3.50
626105-0614-126	6.00	126.00	116.00	3.50
626105-0614-127	6.00	127.00	117.00	3.50
626115-0600-128	6.00	128.00	118.00	3.50
626105-0614-129	6.00	129.00	119.00	3.50
626105-0614-130	6.00	130.00	120.00	3.50
626115-0600-130	6.00	130.00	120.00	4.00
626105-0614-131	6.00	131.00	121.00	3.50
626105-0614-132	6.00	132.00	122.00	3.50
626105-0614-133	6.00	133.00	123.00	3.50
626105-0614-134	6.00	134.00	124.00	3.50
626105-0614-135	6.00	135.00	125.00	3.50
626105-0614-136	6.00	136.00	126.00	3.50
626105-0614-137	6.00	137.00	127.00	3.50
626105-0614-138	6.00	138.00	128.00	3.50
626105-0614-139	6.00	139.00	129.00	3.50
626105-0614-140	6.00	140.00	130.00	3.50
626115-0600-140	6.00	140.00	130.00	4.00
626105-0614-141	6.00	141.00	131.00	3.50
626105-0614-142	6.00	142.00	132.00	3.50
626105-0614-143	6.00	143.00	133.00	3.50
626105-0614-144	6.00	144.00	134.00	3.50
626115-0600-145	6.00	145.00	135.00	3.50
626105-0614-146	6.00	146.00	136.00	3.50
626105-0614-147	6.00	147.00	137.00	3.50
626105-0614-148	6.00	148.00	138.00	3.50
626105-0614-149	6.00	149.00	139.00	3.50
000000-1005-253	6.00	150.00	140.00	3.50
000000-1302-270	6.00	150.00	137.00	4.50
626105-0614-151	6.00	151.00	141.00	3.50
626105-0614-152	6.00	152.00	142.00	3.50
626115-0600-153	6.00	153.00	143.00	3.50
626115-0600-154	6.00	154.00	144.00	3.50
626105-0614-155	6.00	155.00	145.00	3.50
626105-0614-156	6.00	156.00	146.00	3.50
626105-0614-157	6.00	157.00	147.00	3.50
626105-0614-158	6.00	158.00	148.00	3.50
626105-0614-159	6.00	159.00	149.00	3.50
626105-0614-160	6.00	160.00	150.00	3.50
626115-0600-160	6.00	160.00	150.00	4.00
626105-0614-161	6.00	161.00	151.00	3.50



Article-No.	DK	L	ML	DS
626105-0614-162	6.00	162.00	152.00	3.50
626105-0614-163	6.00	163.00	153.00	3.50
626105-0614-164	6.00	164.00	154.00	3.50
626115-0600-165	6.00	165.00	155.00	3.50
626105-0614-166	6.00	166.00	156.00	3.50
626105-0614-167	6.00	167.00	157.00	3.50
626105-0614-168	6.00	168.00	158.00	3.50
626105-0614-169	6.00	169.00	159.00	3.50
626105-0614-170	6.00	170.00	160.00	3.50
626105-0614-171	6.00	171.00	161.00	3.50
626105-0614-172	6.00	172.00	162.00	3.50
626105-0614-173	6.00	173.00	163.00	3.50
626105-0614-174	6.00	174.00	164.00	3.50
626105-0614-175	6.00	175.00	165.00	3.50
626105-0614-176	6.00	176.00	166.00	3.50
626105-0614-177	6.00	177.00	167.00	3.50
626105-0614-178	6.00	178.00	168.00	3.50
626105-0614-179	6.00	179.00	169.00	3.50
626115-0600-180	6.00	180.00	170.00	3.50
626105-0614-181	6.00	181.00	171.00	3.50
626105-0614-182	6.00	182.00	172.00	3.50
626105-0614-183	6.00	183.00	173.00	3.50
626105-0614-184	6.00	184.00	174.00	3.50
626105-0614-185	6.00	185.00	175.00	3.50
626105-0614-186	6.00	186.00	176.00	3.50
626105-0614-187	6.00	187.00	177.00	3.50
626105-0614-188	6.00	188.00	178.00	3.50
626105-0614-189	6.00	189.00	179.00	3.50
626115-0600-200	6.00	200.00	185.00	4.50
626115-0601-200	6.00	200.00	185.00	4.00
626115-0600-233	6.00	233.00	220.00	4.00
626115-0601-250	6.00	250.00	235.00	4.00
626115-0600-300	6.00	300.00	285.00	4.50
626115-0640-030	6.35	30.00	20.00	3.50
626115-0630-060	6.35	60.00	50.00	4.00
626115-0630-090	6.35	90.00	80.00	3.50
626115-0650-040	6.50	40.00	30.00	3.50
626115-0652-050	6.50	50.00	40.00	2.50
626115-0650-050	6.50	50.00	40.00	3.50
626115-0650-055	6.50	55.00	45.00	3.50
626115-0650-075	6.50	75.00	65.00	3.50
626115-0650-080	6.50	80.00	68.00	3.50
626115-0702-020	7.00	20.00	10.00	3.00
626115-0702-030	7.00	30.00	20.00	3.00
626115-0700-050	7.00	50.00	40.00	2.20
600342-8027-000	7.00	55.00	45.00	3.50
626115-0700-055	7.00	55.00	45.00	3.00
626115-0700-060	7.00	60.00	50.00	3.00
626115-0700-070	7.00	70.00	60.00	3.00
626115-0700-075	7.00	75.00	62.00	3.50
626115-0701-075	7.00	75.00	65.00	2.50



Article-No.	DK	L	ML	DS
626115-0700-079	7.00	79.00	69.00	3.00
626115-0700-090	7.00	90.00	80.00	4.00
626115-0701-090	7.00	90.00	80.00	3.00
626115-0700-110	7.00	110.00	100.00	5.00
626115-0701-110	7.00	110.00	100.00	3.00
626115-0700-115	7.00	115.00	105.00	4.00
626115-0700-120	7.00	120.00	110.00	3.00
626115-0701-120	7.00	120.00	107.00	5.00
626115-0700-128	7.00	128.00	118.00	3.00
626115-0700-150	7.00	150.00	137.00	5.00
626115-0700-230	7.00	230.00	217.00	5.00
626115-0750-025	7.50	25.00	15.00	3.50
626115-0750-030	7.50	30.00	20.00	3.00
626115-0751-040	7.50	40.00	30.00	3.00
626115-0750-090	7.50	90.00	80.00	3.50
626115-0800-020	8.00	20.00	10.00	3.00
626105-0824-020	8.00	20.00	7.00	6.00
626115-0800-025	8.00	25.00	12.00	5.00
626115-0801-025	8.00	25.00	15.00	3.00
626115-0800-030	8.00	30.00	18.00	3.00
626105-0824-035	8.00	35.00	22.00	6.00
626105-0824-036	8.00	36.00	23.00	6.00
626105-0824-037	8.00	37.00	24.00	6.00
626105-0824-038	8.00	38.00	25.00	6.00
626115-0800-038	8.00	38.00	28.00	3.00
626105-0824-039	8.00	39.00	26.00	6.00
626105-0824-040	8.00	40.00	27.00	6.00
626115-0805-040	8.00	40.00	30.00	2.00
626105-0824-041	8.00	41.00	28.00	6.00
626105-0824-042	8.00	42.00	29.00	6.00
626105-0824-043	8.00	43.00	30.00	6.00
626105-0824-044	8.00	44.00	31.00	6.00
626105-0824-045	8.00	45.00	32.00	6.00
626115-0800-045	8.00	45.00	35.00	3.00
626105-0824-046	8.00	46.00	33.00	6.00
626115-0800-046	8.00	46.00	36.00	3.00
626105-0824-047	8.00	47.00	34.00	6.00
626105-0824-048	8.00	48.00	35.00	6.00
626105-0824-049	8.00	49.00	36.00	6.00
626105-0824-050	8.00	50.00	37.00	6.00
626115-0800-050	8.00	50.00	38.00	3.00
626105-0824-051	8.00	51.00	38.00	6.00
626105-0824-052	8.00	52.00	39.00	6.00
626105-0824-053	8.00	53.00	40.00	6.00
626105-0824-054	8.00	54.00	41.00	6.00
626105-0824-055	8.00	55.00	42.00	6.00
626105-0824-056	8.00	56.00	43.00	6.00
626105-0824-057	8.00	57.00	44.00	6.00
626105-0824-058	8.00	58.00	45.00	6.00
626105-0824-059	8.00	59.00	46.00	6.00
626105-0824-060	8.00	60.00	47.00	6.00
626115-0802-060	8.00	60.00	50.00	3.00
626115-0808-060	8.00	60.00	47.00	5.00
626105-0824-061	8.00	61.00	48.00	6.00



Article-No.	DK	L	ML	DS
626105-0824-062	8.00	62.00	49.00	6.00
626105-0824-063	8.00	63.00	50.00	6.00
600342-8023-000	8.00	63.50	50.50	6.00
626105-0824-064	8.00	64.00	51.00	6.00
626105-0824-065	8.00	65.00	52.00	6.00
626115-0801-065	8.00	65.00	55.00	3.00
626105-0824-066	8.00	66.00	53.00	6.00
626105-0824-067	8.00	67.00	54.00	6.00
626105-0824-068	8.00	68.00	55.00	6.00
626105-0824-069	8.00	69.00	56.00	6.00
626105-0824-070	8.00	70.00	57.00	6.00
626115-0800-070	8.00	70.00	60.00	3.50
626105-0824-071	8.00	71.00	58.00	6.00
626105-0824-072	8.00	72.00	59.00	6.00
626105-0824-073	8.00	73.00	60.00	6.00
602030-9014-000	8.00	74.00	61.00	6.00
602030-9016-000	8.00	75.00	62.00	6.00
626105-0824-076	8.00	76.00	63.00	6.00
626105-0824-077	8.00	77.00	64.00	6.00
626105-0824-078	8.00	78.00	65.00	6.00
626105-0824-079	8.00	79.00	66.00	6.00
626105-0824-080	8.00	80.00	67.00	6.00
626115-0802-080	8.00	80.00	70.00	3.50
626105-0824-081	8.00	81.00	68.00	6.00
626105-0824-082	8.00	82.00	69.00	6.00
626105-0824-083	8.00	83.00	70.00	6.00
626105-0824-084	8.00	84.00	71.00	6.00
626105-0824-085	8.00	85.00	72.00	6.00
626115-0800-085	8.00	85.00	75.00	6.00
626105-0824-086	8.00	86.00	73.00	6.00
626105-0824-087	8.00	87.00	74.00	6.00
626105-0824-088	8.00	88.00	75.00	6.00
626105-0824-089	8.00	89.00	76.00	6.00
626105-0824-090	8.00	90.00	77.00	6.00
626105-0824-091	8.00	91.00	78.00	6.00
626105-0824-092	8.00	92.00	79.00	6.00
626105-0824-093	8.00	93.00	80.00	6.00
626105-0824-094	8.00	94.00	81.00	6.00
626105-0824-095	8.00	95.00	82.00	6.00
626105-0824-096	8.00	96.00	83.00	6.00
626105-0824-097	8.00	97.00	84.00	6.00
626105-0824-098	8.00	98.00	85.00	6.00
626105-0824-099	8.00	99.00	86.00	6.00
602030-9017-000	8.00	100.00	87.00	6.00
626105-0824-101	8.00	101.00	88.00	6.00
626105-0824-102	8.00	102.00	89.00	6.00
626105-0824-103	8.00	103.00	90.00	6.00
626105-0824-104	8.00	104.00	91.00	6.00
626105-0824-105	8.00	105.00	92.00	6.00
626105-0824-106	8.00	106.00	93.00	6.00
626105-0824-107	8.00	107.00	94.00	6.00



Article-No.	DK	L	ML	DS
626105-0824-108	8.00	108.00	95.00	6.00
626105-0824-109	8.00	109.00	96.00	6.00
626105-0824-110	8.00	110.00	97.00	6.00
626105-0824-111	8.00	111.00	98.00	6.00
626105-0824-112	8.00	112.00	99.00	6.00
626105-0824-113	8.00	113.00	100.00	6.00
626105-0824-114	8.00	114.00	101.00	6.00
626115-0801-114	8.00	114.00	102.00	5.00
600342-8024-000	8.00	114.50	101.50	6.00
626115-0802-114	8.00	114.50	104.50	3.50
626115-0802-115	8.00	114.50	101.50	5.00
626105-0824-115	8.00	115.00	102.00	6.00
626105-0824-116	8.00	116.00	103.00	6.00
626105-0824-117	8.00	117.00	104.00	6.00
626105-0824-118	8.00	118.00	105.00	6.00
626105-0824-119	8.00	119.00	106.00	6.00
626105-0824-120	8.00	120.00	107.00	6.00
626115-0801-120	8.00	120.00	110.00	3.00
626105-0824-121	8.00	121.00	108.00	6.00
626105-0824-122	8.00	122.00	109.00	6.00
626105-0824-123	8.00	123.00	110.00	6.00
626105-0824-124	8.00	124.00	111.00	6.00
626105-0824-125	8.00	125.00	112.00	6.00
626105-0824-126	8.00	126.00	113.00	6.00
626105-0824-127	8.00	127.00	114.00	6.00
626105-0824-128	8.00	128.00	115.00	6.00
626115-0800-128	8.00	128.00	118.00	3.00
626105-0824-129	8.00	129.00	116.00	6.00
626105-0824-130	8.00	130.00	117.00	6.00
626115-0800-130	8.00	130.00	120.00	4.00
626105-0824-131	8.00	131.00	118.00	6.00
626115-0800-131	8.00	131.50	116.50	5.00
626105-0824-132	8.00	132.00	119.00	6.00
626105-0824-133	8.00	133.00	120.00	6.00
626105-0824-134	8.00	134.00	121.00	6.00
626105-0824-135	8.00	135.00	122.00	6.00
626105-0824-136	8.00	136.00	123.00	6.00
626105-0824-137	8.00	137.00	124.00	6.00
626115-0800-137	8.00	137.00	123.00	5.00
000000-1044-753	8.00	138.00	125.00	6.00
626105-0824-139	8.00	139.00	126.00	6.00
626105-0824-140	8.00	140.00	127.00	6.00
626115-0800-140	8.00	140.00	130.00	3.50
626105-0824-141	8.00	141.00	128.00	6.00
626105-0824-142	8.00	142.00	129.00	6.00
626105-0824-143	8.00	143.00	130.00	6.00
626105-0824-144	8.00	144.00	131.00	6.00
626105-0824-145	8.00	145.00	132.00	6.00
626105-0824-146	8.00	146.00	133.00	6.00
626105-0824-147	8.00	147.00	134.00	6.00
626105-0824-148	8.00	148.00	135.00	6.00
626105-0824-149	8.00	149.00	136.00	6.00
626115-0801-150	8.00	150.00	140.00	6.00
626115-0803-150	8.00	150.00	137.00	6.00



Article-No.	DK	L	ML	DS
626105-0824-151	8.00	151.00	138.00	6.00
626105-0824-152	8.00	152.00	139.00	6.00
626105-0824-153	8.00	153.00	140.00	6.00
626105-0824-154	8.00	154.00	141.00	6.00
626105-0824-155	8.00	155.00	142.00	6.00
626105-0824-156	8.00	156.00	143.00	6.00
626105-0824-157	8.00	157.00	144.00	6.00
626105-0824-158	8.00	158.00	145.00	6.00
626105-0824-159	8.00	159.00	146.00	6.00
626105-0824-160	8.00	160.00	147.00	6.00
626115-0804-160	8.00	160.00	150.00	4.00
626105-0824-161	8.00	161.00	148.00	6.00
626105-0824-162	8.00	162.00	149.00	6.00
626105-0824-163	8.00	163.00	150.00	6.00
626105-0824-164	8.00	164.00	151.00	6.00
626105-0824-165	8.00	165.00	152.00	6.00
626115-0800-165	8.00	165.00	150.00	6.00
626105-0824-166	8.00	166.00	153.00	6.00
626105-0824-167	8.00	167.00	154.00	6.00
626105-0824-168	8.00	168.00	155.00	6.00
626105-0824-169	8.00	169.00	156.00	6.00
626105-0824-170	8.00	170.00	157.00	6.00
626105-0824-171	8.00	171.00	158.00	6.00
626105-0824-172	8.00	172.00	159.00	6.00
626105-0824-173	8.00	173.00	160.00	6.00
626105-0824-174	8.00	174.00	161.00	6.00
626105-0824-175	8.00	175.00	162.00	6.00
626115-0800-175	8.00	175.00	160.00	6.00
626105-0824-176	8.00	176.00	163.00	6.00
626105-0824-177	8.00	177.00	164.00	6.00
626105-0824-178	8.00	178.00	165.00	6.00
626105-0824-179	8.00	179.00	166.00	6.00
626105-0824-180	8.00	180.00	167.00	6.00
626115-0800-180	8.00	180.00	166.00	6.00
626105-0824-181	8.00	181.00	168.00	6.00
626105-0824-182	8.00	182.00	169.00	6.00
626105-0824-183	8.00	183.00	170.00	6.00
626105-0824-184	8.00	184.00	171.00	6.00
626105-0824-185	8.00	185.00	172.00	6.00
626105-0824-186	8.00	186.00	173.00	6.00
626105-0824-187	8.00	187.00	174.00	6.00
626105-0824-188	8.00	188.00	175.00	6.00
626105-0824-189	8.00	189.00	176.00	6.00
626115-0800-193	8.00	193.00	180.00	6.00
626115-0800-200	8.00	200.00	186.00	6.00
626115-0803-210	8.00	210.00	200.00	3.00
626115-0801-210	8.00	210.00	196.00	6.00
626115-0800-212	8.00	212.00	198.00	6.00
626115-0802-220	8.00	220.00	207.00	6.00
626115-0800-245	8.00	245.00	232.00	6.00
626115-0800-300	8.00	300.00	280.00	6.00





Article-No.	DK	L	ML	DS
626115-0800-313	8.00	313.00	300.00	6.00
626115-0800-320	8.00	320.00	307.00	6.00
626115-0850-075	8.50	75.00	62.00	6.00
626115-0900-020	9.00	20.00	10.00	2.00
626115-0901-030	9.00	30.00	20.00	5.00
626115-0903-030	9.00	30.00	20.00	1.50
626115-0900-050	9.00	50.00	37.00	6.00
600342-8028-000	9.00	64.50	51.50	6.00
626115-0900-075	9.00	75.00	63.00	3.00
626115-0900-085	9.00	85.00	75.00	3.00
626115-0901-085	9.00	85.00	75.00	2.50
626115-0900-115	9.00	115.00	101.00	6.00
626115-0900-202	9.00	202.00	189.00	6.00
626115-1000-023	10.00	23.00	10.00	5.00
626115-1000-025	10.00	25.00	12.00	4.00
626115-1001-030	10.00	30.00	17.00	5.00
626105-1000-033	10.00	33.00	20.00	6.00
626105-1024-035	10.00	35.00	22.00	6.00
626105-1024-036	10.00	36.00	23.00	6.00
626105-1024-037	10.00	37.00	24.00	6.00
626105-1024-038	10.00	38.00	25.00	6.00
626105-1024-039	10.00	39.00	26.00	6.00
626105-1024-040	10.00	40.00	27.00	6.00
626105-1024-041	10.00	41.00	28.00	6.00
626105-1024-042	10.00	42.00	29.00	6.00
626105-1024-043	10.00	43.00	30.00	6.00
626105-1024-044	10.00	44.00	31.00	6.00
626105-1024-045	10.00	45.00	32.00	6.00
626105-1024-046	10.00	46.00	33.00	6.00
626105-1024-047	10.00	47.00	34.00	6.00
626105-1024-048	10.00	48.00	35.00	6.00
626105-1024-049	10.00	49.00	36.00	6.00
626105-1024-050	10.00	50.00	37.00	6.00
626105-1024-051	10.00	51.00	38.00	6.00
626105-1024-052	10.00	52.00	39.00	6.00
626105-1024-053	10.00	53.00	40.00	6.00
626105-1024-054	10.00	54.00	41.00	6.00
626105-1024-055	10.00	55.00	42.00	6.00
626105-1024-056	10.00	56.00	43.00	6.00
626105-1024-057	10.00	57.00	44.00	6.00
626105-1024-058	10.00	58.00	45.00	6.00
626105-1024-059	10.00	59.00	46.00	6.00
626105-1024-060	10.00	60.00	47.00	6.00
626115-1004-060	10.00	60.00	50.00	3.00
626105-1024-061	10.00	61.00	48.00	6.00
626105-1024-062	10.00	62.00	49.00	6.00
626105-1024-063	10.00	63.00	50.00	6.00
626105-1024-064	10.00	64.00	51.00	6.00
626105-1024-065	10.00	65.00	52.00	6.00
600342-8029-000	10.00	65.50	52.50	6.00
626105-1024-066	10.00	66.00	53.00	6.00
626115-1001-066	10.00	66.00	56.00	4.00
626105-1024-067	10.00	67.00	54.00	6.00
626105-1024-068	10.00	68.00	55.00	6.00



Article-No.	DK	L	ML	DS
626105-1024-069	10.00	69.00	56.00	6.00
626105-1024-070	10.00	70.00	57.00	6.00
626105-1024-071	10.00	71.00	58.00	6.00
626105-1024-072	10.00	72.00	59.00	6.00
626105-1024-073	10.00	73.00	60.00	6.00
626105-1024-074	10.00	74.00	61.00	6.00
626105-1024-075	10.00	75.00	62.00	6.00
626105-1024-076	10.00	76.00	63.00	6.00
626105-1024-077	10.00	77.00	64.00	6.00
626105-1024-078	10.00	78.00	65.00	6.00
626105-1024-079	10.00	79.00	66.00	6.00
626105-1024-080	10.00	80.00	67.00	6.00
626105-1024-081	10.00	81.00	68.00	6.00
626105-1024-082	10.00	82.00	69.00	6.00
626105-1024-083	10.00	83.00	70.00	6.00
626105-1024-084	10.00	84.00	71.00	6.00
626105-1024-085	10.00	85.00	72.00	6.00
626105-1024-086	10.00	86.00	73.00	6.00
626105-1024-087	10.00	87.00	74.00	6.00
626105-1024-088	10.00	88.00	75.00	6.00
626105-1024-089	10.00	89.00	76.00	6.00
626105-1024-090	10.00	90.00	77.00	6.00
626105-1024-091	10.00	91.00	78.00	6.00
626105-1024-092	10.00	92.00	79.00	6.00
626105-1024-093	10.00	93.00	80.00	6.00
626105-1024-094	10.00	94.00	81.00	6.00
626105-1024-095	10.00	95.00	82.00	6.00
626105-1024-096	10.00	96.00	83.00	6.00
626105-1024-097	10.00	97.00	84.00	6.00
626105-1024-098	10.00	98.00	85.00	6.00
626105-1024-099	10.00	99.00	86.00	6.00
626105-1024-100	10.00	100.00	87.00	6.00
626105-1024-101	10.00	101.00	88.00	6.00
626105-1024-102	10.00	102.00	89.00	6.00
626105-1024-103	10.00	103.00	90.00	6.00
626105-1024-104	10.00	104.00	91.00	6.00
626105-1024-105	10.00	105.00	92.00	6.00
626105-1024-106	10.00	106.00	93.00	6.00
626105-1024-107	10.00	107.00	94.00	6.00
626105-1024-108	10.00	108.00	95.00	6.00
626105-1024-109	10.00	109.00	96.00	6.00
626105-1024-110	10.00	110.00	97.00	6.00
626115-1001-110	10.00	110.00	100.00	3.50
626105-1024-111	10.00	111.00	98.00	6.00
626105-1024-112	10.00	112.00	99.00	6.00
626105-1024-113	10.00	113.00	100.00	6.00
626105-1024-114	10.00	114.00	101.00	6.00
626105-1024-115	10.00	115.00	102.00	6.00
626105-1024-116	10.00	116.00	103.00	6.00
626105-1024-117	10.00	117.00	104.00	6.00
612030-9624-000	10.00	117.50	104.50	6.00



Article-No.	DK	L	ML	DS
602030-9018-000	10.00	118.00	105.00	6.00
626105-1024-119	10.00	119.00	106.00	6.00
626105-1024-120	10.00	120.00	107.00	6.00
626105-1024-121	10.00	121.00	108.00	6.00
626105-1024-122	10.00	122.00	109.00	6.00
626105-1024-123	10.00	123.00	110.00	6.00
626105-1024-124	10.00	124.00	111.00	6.00
626105-1024-125	10.00	125.00	112.00	6.00
626105-1024-126	10.00	126.00	113.00	6.00
626105-1024-127	10.00	127.00	114.00	6.00
626105-1024-128	10.00	128.00	115.00	6.00
626105-1024-129	10.00	129.00	116.00	6.00
626105-1024-130	10.00	130.00	117.00	6.00
626105-1024-131	10.00	131.00	118.00	6.00
626105-1024-132	10.00	132.00	119.00	6.00
626105-1024-133	10.00	133.00	120.00	6.00
626105-1024-134	10.00	134.00	121.00	6.00
626105-1024-135	10.00	135.00	122.00	6.00
626115-1000-135	10.00	135.00	125.00	4.00
626105-1024-136	10.00	136.00	123.00	6.00
626105-1024-137	10.00	137.00	124.00	6.00
626105-1024-138	10.00	138.00	125.00	6.00
626105-1024-139	10.00	139.00	126.00	6.00
626105-1024-140	10.00	140.00	127.00	6.00
626105-1024-141	10.00	141.00	128.00	6.00
626105-1024-142	10.00	142.00	129.00	6.00
626105-1024-143	10.00	143.00	130.00	6.00
626105-1024-144	10.00	144.00	131.00	6.00
626105-1024-145	10.00	145.00	132.00	6.00
626105-1024-146	10.00	146.00	133.00	6.00
626105-1024-147	10.00	147.00	134.00	6.00
626105-1024-148	10.00	148.00	135.00	6.00
626105-1024-149	10.00	149.00	136.00	6.00
626105-1024-150	10.00	150.00	137.00	6.00
626105-1024-151	10.00	151.00	138.00	6.00
626105-1024-152	10.00	152.00	139.00	6.00
626105-1024-153	10.00	153.00	140.00	6.00
626105-1024-154	10.00	154.00	141.00	6.00
626105-1024-155	10.00	155.00	142.00	6.00
626105-1024-156	10.00	156.00	143.00	6.00
626105-1024-157	10.00	157.00	144.00	6.00
626105-1024-158	10.00	158.00	145.00	6.00
626105-1024-159	10.00	159.00	146.00	6.00
626105-1024-160	10.00	160.00	147.00	6.00
626105-1024-161	10.00	161.00	148.00	6.00
626105-1024-162	10.00	162.00	149.00	6.00
626105-1024-163	10.00	163.00	150.00	6.00
626105-1024-164	10.00	164.00	151.00	6.00
626105-1024-165	10.00	165.00	152.00	6.00
626105-1024-166	10.00	166.00	153.00	6.00
626105-1024-167	10.00	167.00	154.00	6.00
626105-1024-168	10.00	168.00	155.00	6.00
626105-1024-169	10.00	169.00	156.00	6.00
626105-1024-170	10.00	170.00	157.00	6.00



Article-No.	DK	L	ML	DS
626105-1024-171	10.00	171.00	158.00	6.00
626105-1024-172	10.00	172.00	159.00	6.00
626105-1024-173	10.00	173.00	160.00	6.00
626105-1024-174	10.00	174.00	161.00	6.00
626105-1024-175	10.00	175.00	162.00	6.00
626105-1024-176	10.00	176.00	163.00	6.00
626105-1024-177	10.00	177.00	164.00	6.00
626105-1024-178	10.00	178.00	165.00	6.00
626105-1024-179	10.00	179.00	166.00	6.00
626105-1024-180	10.00	180.00	167.00	6.00
626105-1024-181	10.00	181.00	168.00	6.00
626105-1024-182	10.00	182.00	169.00	6.00
626105-1024-183	10.00	183.00	170.00	6.00
626105-1024-184	10.00	184.00	171.00	6.00
626105-1024-185	10.00	185.00	172.00	6.00
626105-1024-186	10.00	186.00	173.00	6.00
626105-1024-187	10.00	187.00	174.00	6.00
626105-1024-188	10.00	188.00	175.00	6.00
626105-1024-189	10.00	189.00	176.00	6.00
626115-1000-195	10.00	195.00	180.00	6.00
626115-1002-200	10.00	200.00	187.00	6.00
626115-1000-210	10.00	210.00	196.00	6.00
626115-1000-230	10.00	230.00	216.00	6.00
626115-1000-250	10.00	250.00	235.00	6.00
626115-1000-350	10.00	345.00	332.00	6.00
626115-1100-115	11.00	115.00	102.00	5.00
626105-1200-030	12.00	30.00	17.00	6.00
626105-1200-033	12.00	33.00	20.00	6.00
626105-1224-035	12.00	35.00	22.00	6.00
626105-1224-036	12.00	36.00	23.00	6.00
626105-1224-037	12.00	37.00	24.00	6.00
626105-1224-038	12.00	38.00	25.00	6.00
626105-1224-039	12.00	39.00	26.00	6.00
626105-1224-040	12.00	40.00	27.00	6.00
626115-1200-040	12.00	40.00	28.00	5.00
626105-1224-041	12.00	41.00	28.00	6.00
626105-1224-042	12.00	42.00	29.00	6.00
626105-1224-043	12.00	43.00	30.00	6.00
626105-1224-044	12.00	44.00	31.00	6.00
626105-1224-045	12.00	45.00	32.00	6.00
626105-1224-046	12.00	46.00	33.00	6.00
626105-1224-047	12.00	47.00	34.00	6.00
626105-1224-048	12.00	48.00	35.00	6.00
626105-1224-049	12.00	49.00	36.00	6.00
626105-1224-050	12.00	50.00	37.00	6.00
626115-1200-050	12.00	50.00	36.00	6.00
626105-1224-051	12.00	51.00	38.00	6.00
626105-1224-052	12.00	52.00	39.00	6.00
626105-1224-053	12.00	53.00	40.00	6.00
626105-1224-054	12.00	54.00	41.00	6.00
626105-1224-055	12.00	55.00	42.00	6.00



Article-No.	DK	L	ML	DS
626105-1224-056	12.00	56.00	43.00	6.00
626105-1224-057	12.00	57.00	44.00	6.00
626105-1224-058	12.00	58.00	45.00	6.00
626105-1224-059	12.00	59.00	46.00	6.00
626105-1224-060	12.00	60.00	47.00	6.00
626115-1200-060	12.00	60.00	46.00	5.00
626105-1224-061	12.00	61.00	48.00	6.00
626105-1224-062	12.00	62.00	49.00	6.00
626105-1224-063	12.00	63.00	50.00	6.00
626105-1224-064	12.00	64.00	51.00	6.00
626115-1200-065	12.00	65.00	52.00	6.00
626105-1224-066	12.00	66.00	53.00	6.00
626105-1224-067	12.00	67.00	54.00	6.00
626105-1224-068	12.00	68.00	55.00	6.00
626105-1224-069	12.00	69.00	56.00	6.00
626105-1224-070	12.00	70.00	57.00	6.00
626105-1224-071	12.00	71.00	58.00	6.00
626105-1224-072	12.00	72.00	59.00	6.00
626105-1224-073	12.00	73.00	60.00	6.00
626105-1224-074	12.00	74.00	61.00	6.00
626105-1224-075	12.00	75.00	62.00	6.00
626105-1224-076	12.00	76.00	63.00	6.00
626105-1224-077	12.00	77.00	64.00	6.00
626105-1224-078	12.00	78.00	65.00	6.00
626105-1224-079	12.00	79.00	66.00	6.00
626105-1224-080	12.00	80.00	67.00	6.00
626105-1224-081	12.00	81.00	68.00	6.00
626105-1224-082	12.00	82.00	69.00	6.00
626105-1224-083	12.00	83.00	70.00	6.00
626105-1224-084	12.00	84.00	71.00	6.00
626105-1224-085	12.00	85.00	72.00	6.00
626105-1224-086	12.00	86.00	73.00	6.00
626105-1224-087	12.00	87.00	74.00	6.00
626105-1224-088	12.00	88.00	75.00	6.00
626105-1224-089	12.00	89.00	76.00	6.00
626105-1224-090	12.00	90.00	77.00	6.00
626105-1224-091	12.00	91.00	78.00	6.00
626105-1224-092	12.00	92.00	79.00	6.00
626105-1224-093	12.00	93.00	80.00	6.00
626105-1224-094	12.00	94.00	81.00	6.00
626105-1224-095	12.00	95.00	82.00	6.00
626105-1224-096	12.00	96.00	83.00	6.00
626105-1224-097	12.00	97.00	84.00	6.00
626105-1224-098	12.00	98.00	85.00	6.00
626105-1224-099	12.00	99.00	86.00	6.00
626105-1224-100	12.00	100.00	87.00	6.00
626115-1200-100	12.00	100.00	86.00	6.00
626115-1201-100	12.00	100.00	90.00	4.50
626105-1224-101	12.00	101.00	88.00	6.00
626105-1224-102	12.00	102.00	89.00	6.00
626105-1224-103	12.00	103.00	90.00	6.00
626105-1224-104	12.00	104.00	91.00	6.00
626105-1224-105	12.00	105.00	92.00	6.00
626105-1224-106	12.00	106.00	93.00	6.00



Article-No.	DK	L	ML	DS
626105-1224-107	12.00	107.00	94.00	6.00
626105-1224-108	12.00	108.00	95.00	6.00
626105-1224-109	12.00	109.00	96.00	6.00
626105-1224-110	12.00	110.00	97.00	6.00
626105-1224-111	12.00	111.00	98.00	6.00
626105-1224-112	12.00	112.00	99.00	6.00
626105-1224-113	12.00	113.00	100.00	6.00
626105-1224-114	12.00	114.00	101.00	6.00
626105-1224-115	12.00	115.00	102.00	6.00
626105-1224-116	12.00	116.00	103.00	6.00
626105-1224-117	12.00	117.00	104.00	6.00
626105-1224-118	12.00	118.00	105.00	6.00
626115-1200-118	12.00	118.00	105.00	6.00
626105-1224-119	12.00	119.00	106.00	6.00
626105-1224-120	12.00	120.00	107.00	6.00
626105-1224-121	12.00	121.00	108.00	6.00
626105-1224-122	12.00	122.00	109.00	6.00
626105-1224-123	12.00	123.00	110.00	6.00
626105-1224-124	12.00	124.00	111.00	6.00
626105-1224-125	12.00	125.00	112.00	6.00
626105-1224-126	12.00	126.00	113.00	6.00
626105-1224-127	12.00	127.00	114.00	6.00
626105-1224-128	12.00	128.00	115.00	6.00
626105-1224-129	12.00	129.00	116.00	6.00
626105-1224-130	12.00	130.00	117.00	6.00
626105-1224-131	12.00	131.00	118.00	6.00
626105-1224-132	12.00	132.00	119.00	6.00
626105-1224-133	12.00	133.00	120.00	6.00
626105-1224-134	12.00	134.00	121.00	6.00
626105-1224-135	12.00	135.00	122.00	6.00
626105-1224-136	12.00	136.00	123.00	6.00
626105-1224-137	12.00	137.00	124.00	6.00
626105-1224-138	12.00	138.00	125.00	6.00
626105-1224-139	12.00	139.00	126.00	6.00
626105-1224-140	12.00	140.00	127.00	6.00
626105-1224-141	12.00	141.00	128.00	6.00
626105-1224-142	12.00	142.00	129.00	6.00
626105-1224-143	12.00	143.00	130.00	6.00
626105-1224-144	12.00	144.00	131.00	6.00
626105-1224-145	12.00	145.00	132.00	6.00
626105-1224-146	12.00	146.00	133.00	6.00
626105-1224-147	12.00	147.00	134.00	6.00
626105-1224-148	12.00	148.00	135.00	6.00
626105-1224-149	12.00	149.00	136.00	6.00
626105-1224-150	12.00	150.00	137.00	6.00
626105-1224-151	12.00	151.00	138.00	6.00
626105-1224-152	12.00	152.00	139.00	6.00
626105-1224-153	12.00	153.00	140.00	6.00
626105-1224-154	12.00	154.00	141.00	6.00
626105-1224-155	12.00	155.00	142.00	6.00
626105-1224-156	12.00	156.00	143.00	6.00



Article-No.	DK	L	ML	DS
626105-1224-157	12.00	157.00	144.00	6.00
626105-1224-158	12.00	158.00	145.00	6.00
626105-1224-159	12.00	159.00	146.00	6.00
000000-1021-659	12.00	160.00	147.00	5.00
626105-1224-160	12.00	160.00	147.00	6.00
626105-1224-161	12.00	161.00	148.00	6.00
626105-1224-162	12.00	162.00	149.00	6.00
626105-1224-163	12.00	163.00	150.00	6.00
626105-1224-164	12.00	164.00	151.00	6.00
626105-1224-165	12.00	165.00	152.00	6.00
626105-1224-166	12.00	166.00	153.00	6.00
626105-1224-167	12.00	167.00	154.00	6.00
626105-1224-168	12.00	168.00	155.00	6.00
626105-1224-169	12.00	169.00	156.00	6.00
626105-1224-170	12.00	170.00	157.00	6.00
626105-1224-171	12.00	171.00	158.00	6.00
626105-1224-172	12.00	172.00	159.00	6.00
626105-1224-173	12.00	173.00	160.00	6.00
626105-1224-174	12.00	174.00	161.00	6.00
626105-1224-175	12.00	175.00	162.00	6.00
626115-1200-175	12.00	175.00	161.00	6.00
626105-1224-176	12.00	176.00	163.00	6.00
626105-1224-177	12.00	177.00	164.00	6.00
626105-1224-178	12.00	178.00	165.00	6.00
626105-1224-179	12.00	179.00	166.00	6.00
626105-1224-180	12.00	180.00	167.00	6.00
626115-1200-180	12.00	180.00	167.00	5.00
626105-1224-181	12.00	181.00	168.00	6.00
626105-1224-182	12.00	182.00	169.00	6.00
626105-1224-183	12.00	183.00	170.00	6.00
626105-1224-184	12.00	184.00	171.00	6.00
626105-1224-185	12.00	185.00	172.00	6.00
626105-1224-186	12.00	186.00	173.00	6.00
626105-1224-187	12.00	187.00	174.00	6.00
626105-1224-188	12.00	188.00	175.00	6.00
626105-1224-189	12.00	189.00	176.00	6.00
626115-1200-235	12.00	235.00	215.00	10.00
000000-1266-539	12.00	240.00	215.00	8.00
626115-1200-243	12.00	243.00	230.00	8.00
626115-1270-050	12.70	50.00	37.00	5.00
626115-1400-065	14.00	65.00	52.00	6.00
626115-1402-118	14.00	118.00	105.00	6.00

## M5, Styli straight, ruby sphere, carbon fibre shaft

Standard Styli suitable for all common measuring tasks. M5 thread for VAST active scanning sensors.

Connection Type: M5  
 Shaft Material: Carbon Fiber  
 Stylus Tip Geometry: Sphere  
 Stylus Tip Material: Ruby  
 Ø Body (DG): 11

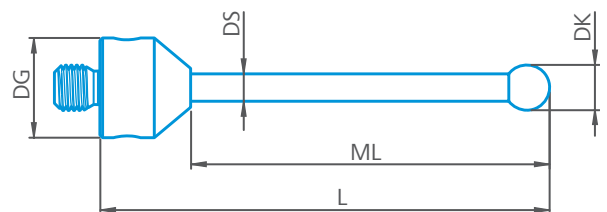

Article-No.	DK	L	ML	DS
626115-0170-080	1.75	80.00	70.00	1.50
626115-0208-033	2.00	33.00	23.00	1.50
626105-0300-025	3.00	25.00	15.00	2.00
626105-0300-033	3.00	33.00	23.00	2.00
626105-0300-050	3.00	50.00	40.00	2.00
626105-0300-052	3.00	52.00	42.00	2.00
626105-0310-053	3.00	53.00	43.00	2.00
626105-0300-058	3.00	58.00	48.00	2.00
626105-0300-064	3.00	64.00	54.00	2.00
626105-0301-075	3.00	75.00	65.00	2.00
626105-0300-075	3.50	75.00	65.00	2.00
626105-0400-033	4.00	33.00	23.00	2.00
626105-0400-050	4.00	50.00	40.00	2.00
626105-0400-058	4.00	58.00	48.00	2.00
626105-0400-064	4.00	64.00	54.00	2.00
626105-0410-065	4.00	65.00	55.00	3.50
626105-0400-075	4.00	75.00	65.00	2.00
626105-0400-090	4.00	90.00	80.00	3.50
626105-0410-100	4.00	100.00	90.00	3.50
626105-0400-110	4.00	110.00	100.00	3.50
626105-0410-120	4.00	120.00	110.00	3.50
626105-0400-140	4.00	140.00	130.00	3.50
626105-0410-150	4.00	150.00	140.00	3.50
626105-0510-050	5.00	50.00	40.00	3.50
626105-0510-055	5.00	55.00	45.00	3.50
626105-0510-075	5.00	75.00	65.00	3.50
626105-0510-080	5.00	80.00	70.00	3.50
626105-0510-090	5.00	90.00	80.00	3.50
626105-0510-100	5.00	100.00	90.00	3.50
626105-0510-110	5.00	110.00	100.00	3.50
626105-0510-120	5.00	120.00	107.00	3.50
626105-0510-130	5.00	130.00	120.00	3.50
626105-0510-135	5.00	135.00	125.00	3.50
626105-0510-150	5.00	150.00	140.00	3.50
626105-0510-200	5.00	200.00	180.00	3.50
626115-0600-053	6.00	53.00	43.00	4.00
626105-0610-054	6.00	54.00	44.00	3.50
626105-0610-058	6.00	58.00	48.00	3.50
626105-0610-075	6.00	75.00	65.00	3.50
626105-0610-100	6.00	100.00	90.00	3.50
626105-0610-105	6.00	105.00	95.00	3.50
626105-0610-110	6.00	110.00	100.00	3.50
626120-0056-000	6.00	153.00	123.00	4.00
626105-0710-055	7.00	55.00	45.00	3.50
626105-0710-116	7.00	116.00	106.00	3.50
626105-0720-154	7.00	153.50	140.30	6.00
626105-0820-063	8.00	63.00	50.00	6.00
626105-0820-075	8.00	75.00	62.00	6.00
626105-0820-080	8.00	80.00	67.00	6.00
626105-0820-100	8.00	100.00	87.00	6.00
626105-0820-114	8.00	114.00	101.00	6.00





Article-No.	DK	L	ML	DS
626105-0820-120	8.00	120.00	107.00	6.00
626105-0820-150	8.00	150.00	137.00	6.00
626105-0820-175	8.00	175.00	162.00	6.00
626105-0820-200	8.00	200.00	187.00	6.00
626105-0820-204	8.00	204.00	191.00	6.00
626105-0820-220	8.00	220.00	195.00	6.00
626105-0820-240	8.00	240.00	215.00	6.00
626105-0820-250	8.00	250.00	225.00	6.00
626105-0820-265	8.00	265.00	240.00	6.00
626105-0820-300	8.00	300.00	275.00	6.00
626105-0820-310	8.00	310.00	285.00	6.00
626105-0820-320	8.00	320.00	295.00	6.00
626105-0820-400	8.00	400.00	375.00	6.00
626105-1020-030	10.00	30.00	20.00	6.00
626105-1020-065	10.00	65.00	52.00	6.00
626105-1020-118	10.00	118.00	105.00	6.00
626105-1020-150	10.00	150.00	137.00	6.00
626105-1020-165	10.00	165.00	152.00	6.00
626105-1020-170	10.00	170.00	157.00	6.00
626105-1020-200	10.00	200.00	187.00	6.00
626105-1020-220	10.00	220.00	207.00	6.00
626105-1022-225	10.00	225.00	200.00	6.00
626105-1020-225	10.00	225.00	212.00	6.00
626105-1020-235	10.00	235.00	210.00	6.00
626105-1020-250	10.00	250.00	225.00	6.00
626105-1000-275	10.00	275.00	250.00	6.00
626105-1020-300	10.00	300.00	275.00	6.00
626105-1020-325	10.00	325.00	300.00	6.00
626105-1020-350	10.00	350.00	325.00	6.00
626105-1020-413	10.00	413.00	388.00	6.00
626105-1000-425	10.00	425.00	400.00	6.00
626105-1020-500	10.00	500.00	475.00	6.00
626105-1120-060	11.00	60.00	50.00	6.00
626105-1220-120	12.00	120.00	105.00	6.00
626105-1220-225	12.00	225.00	200.00	6.00
626115-1200-260	12.00	260.00	240.00	8.00
626105-1220-280	12.00	280.00	255.00	6.00
626105-1220-355	12.00	355.00	330.00	6.00

## M5, Styli straight, ruby sphere, ceramic shaft

Standard Styli suitable for all common measuring tasks. M5 thread for VAST active scanning sensors.

Connection Type: M5  
 Shaft Material: Ceramic  
 Stylus Tip Geometry: Sphere  
 Stylus Tip Material: Ruby  
 Ø Body (DG): 11

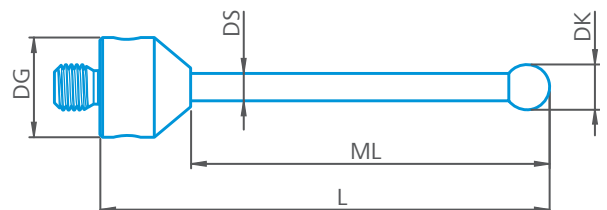

Article-No.	DK	L	ML	DS
626115-0206-040	2.00	40.00	30.00	1.50
600342-8013-000	5.00	53.00	43.00	3.50
000000-1060-050	5.00	140.00	128.00	3.50
600342-8016-000	6.00	54.00	44.00	3.50
600342-8017-000	7.00	55.00	45.00	3.50
600342-8014-000	8.00	63.50	50.50	6.00
600342-8015-000	8.00	114.50	101.50	6.00
000000-1046-848	8.00	140.00	125.00	6.00
600342-8018-000	9.00	64.50	51.50	6.00
600342-8019-000	10.00	65.50	52.50	6.00
626115-1001-175	10.00	175.00	162.00	6.00
626115-1001-200	10.00	200.00	187.00	6.00
626115-1200-200	12.00	200.00	184.00	6.00
626115-1200-315	12.00	315.00	300.00	8.00

### M5, Styli straight, silicon nitride sphere, tungsten carbide shaft

Standard Styli suitable for all common measuring tasks. M5 thread for VAST active scanning sensors.

Connection Type: M5  
 Shaft Material: Tung. Carb.  
 Stylus Tip Geometry: Sphere  
 Stylus Tip Material: Si. Nitride  
 Ø Body (DG): 11

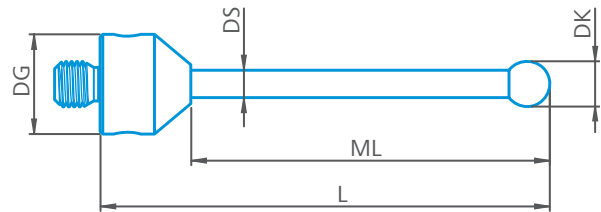

Article-No.	DK	L	ML	DS
626115-0107-030	1.00	30.00	20.00	0.80
626115-0101-033	1.00	33.00	23.00	0.80
626115-0102-040	1.00	40.00	30.00	0.80
626115-0100-070	1.00	70.00	60.00	0.80
626115-5745-013	1.35	13.00	3.00	1.00
626115-5745-014	1.35	14.00	4.00	1.00
626115-5745-015	1.35	15.00	5.00	1.00
626115-5745-016	1.35	16.00	6.00	1.00
626115-5745-017	1.35	17.00	7.00	1.00
626115-5745-018	1.35	18.00	8.00	1.00
626115-5745-019	1.35	19.00	9.00	1.00
626115-5745-020	1.35	20.00	10.00	1.00
626115-5745-021	1.35	21.00	11.00	1.00
626115-5745-022	1.35	22.00	12.00	1.00
626115-5745-023	1.35	23.00	13.00	1.00
626115-5745-024	1.35	24.00	14.00	1.00
626115-5745-025	1.35	25.00	15.00	1.00
626115-5745-026	1.35	26.00	16.00	1.00
626115-5745-027	1.35	27.00	17.00	1.00
626115-5745-028	1.35	28.00	18.00	1.00
626115-5745-029	1.35	29.00	19.00	1.00
626115-5745-030	1.35	30.00	20.00	1.00
626115-5745-031	1.35	31.00	21.00	1.00



<b>Article-No.</b>	<b>DK</b>	<b>L</b>	<b>ML</b>	<b>DS</b>
626115-0141-032	1.35	32.00	22.00	1.00
626115-5745-033	1.35	33.00	23.00	1.00
626115-5745-034	1.35	34.00	24.00	1.00
626115-5745-035	1.35	35.00	25.00	1.00
626115-5745-036	1.35	36.00	26.00	1.00
626115-5745-037	1.35	37.00	27.00	1.00
626115-5745-038	1.35	38.00	28.00	1.00
626115-5745-039	1.35	39.00	29.00	1.00
626115-5745-040	1.35	40.00	30.00	1.00
626115-5745-041	1.35	41.00	31.00	1.00
626115-5745-042	1.35	42.00	32.00	1.00
626115-5745-043	1.35	43.00	33.00	1.00
626115-5745-044	1.35	44.00	34.00	1.00
626115-5745-045	1.35	45.00	35.00	1.00
626105-0145-013	1.50	13.00	3.00	1.00
626105-0145-014	1.50	14.00	4.00	1.00
626105-0145-015	1.50	15.00	5.00	1.00
626105-0145-016	1.50	16.00	6.00	1.00
626105-0145-017	1.50	17.00	7.00	1.00
626105-0145-018	1.50	18.00	8.00	1.00
626105-0145-019	1.50	19.00	9.00	1.00
626115-0154-020	1.50	20.00	10.00	1.00
626105-0145-021	1.50	21.00	11.00	1.00
626105-0145-022	1.50	22.00	12.00	1.00
626105-0145-023	1.50	23.00	13.00	1.00
626105-0145-024	1.50	24.00	14.00	1.00
626115-0151-025	1.50	25.00	15.00	1.00
626105-0145-026	1.50	26.00	16.00	1.00
626105-0145-027	1.50	27.00	17.00	1.00
626105-0145-028	1.50	28.00	18.00	1.00
626105-0145-029	1.50	29.00	19.00	1.00
626115-0152-030	1.50	30.00	20.00	1.00
626105-0145-031	1.50	31.00	21.00	1.00
626105-0145-032	1.50	32.00	22.00	1.00
626105-0145-033	1.50	33.00	23.00	1.00
000000-1323-893	1.50	33.00	24.00	1.00
626105-0145-034	1.50	34.00	24.00	1.00
626105-0145-035	1.50	35.00	25.00	1.00
626105-0145-036	1.50	36.00	26.00	1.00
626105-0145-037	1.50	37.00	27.00	1.00
626105-0145-038	1.50	38.00	28.00	1.00
626105-0145-039	1.50	39.00	29.00	1.00
626105-0145-040	1.50	40.00	30.00	1.00
626105-0145-041	1.50	41.00	31.00	1.00
626105-0145-042	1.50	42.00	32.00	1.00
626105-0145-043	1.50	43.00	33.00	1.00
626105-0145-044	1.50	44.00	34.00	1.00
626105-0145-045	1.50	45.00	35.00	1.00
626105-0145-046	1.50	46.00	36.00	1.00
626105-0145-047	1.50	47.00	37.00	1.00
626105-0145-048	1.50	48.00	38.00	1.00
626105-0145-049	1.50	49.00	39.00	1.00
626105-0145-050	1.50	50.00	40.00	1.00
626105-0145-051	1.50	51.00	41.00	1.00



Article-No.	DK	L	ML	DS
626105-0145-052	1.50	52.00	42.00	1.00
626105-0145-053	1.50	53.00	43.00	1.00
626105-0145-054	1.50	54.00	44.00	1.00
626105-0145-055	1.50	55.00	45.00	1.00
626105-0145-056	1.50	56.00	46.00	1.00
626105-0145-057	1.50	57.00	47.00	1.00
626105-0145-058	1.50	58.00	48.00	1.00
626105-0145-059	1.50	59.00	49.00	1.00
626105-0145-060	1.50	60.00	50.00	1.00
626105-0145-061	1.50	61.00	51.00	1.00
626115-0152-080	1.50	80.00	70.00	1.00
626105-0255-013	2.00	13.00	3.00	1.50
626105-0255-014	2.00	14.00	4.00	1.50
626105-0255-015	2.00	15.00	5.00	1.50
626105-0255-016	2.00	16.00	6.00	1.50
626105-0255-017	2.00	17.00	7.00	1.50
626105-0255-018	2.00	18.00	8.00	1.50
626105-0255-019	2.00	19.00	9.00	1.50
626105-0255-020	2.00	20.00	10.00	1.50
626115-0204-020	2.00	20.00	10.00	1.00
626105-0255-021	2.00	21.00	11.00	1.50
626105-0255-022	2.00	22.00	12.00	1.50
626105-0255-023	2.00	23.00	13.00	1.50
626105-0255-024	2.00	24.00	14.00	1.50
626115-0200-024	2.00	24.00	14.00	1.00
626105-0255-025	2.00	25.00	15.00	1.50
626105-0245-025	2.00	25.00	15.00	1.00
626105-0255-026	2.00	26.00	16.00	1.50
626105-0255-027	2.00	27.00	17.00	1.50
626105-0255-028	2.00	28.00	18.00	1.50
626105-0255-029	2.00	29.00	19.00	1.50
626105-0255-030	2.00	30.00	20.00	1.50
626115-0205-030	2.00	30.00	20.00	2.00
626105-0255-031	2.00	31.00	21.00	1.50
626105-0255-032	2.00	32.00	22.00	1.50
626115-0201-032	2.00	32.00	22.00	1.00
626115-0206-033	2.00	33.00	23.00	1.50
626105-0200-033	2.00	33.00	23.00	1.00
000000-1323-889	2.00	33.50	24.50	1.50
626105-0255-034	2.00	34.00	24.00	1.50
626105-0255-035	2.00	35.00	25.00	1.50
626105-0255-036	2.00	36.00	26.00	1.50
626105-0255-037	2.00	37.00	27.00	1.50
626105-0255-038	2.00	38.00	28.00	1.50
626105-0255-039	2.00	39.00	29.00	1.50
626115-0202-040	2.00	40.00	30.00	1.50
626105-0200-040	2.00	40.00	30.00	1.00
626105-0255-041	2.00	41.00	31.00	1.50
626105-0255-042	2.00	42.00	32.00	1.50
626105-0255-043	2.00	43.00	33.00	1.50
626105-0255-044	2.00	44.00	34.00	1.50



Article-No.	DK	L	ML	DS
626105-0255-045	2.00	45.00	35.00	1.50
626105-0255-046	2.00	46.00	36.00	1.50
626105-0255-047	2.00	47.00	37.00	1.50
626105-0255-048	2.00	48.00	38.00	1.50
626105-0255-049	2.00	49.00	39.00	1.50
626105-0255-050	2.00	50.00	40.00	1.50
626115-0201-050	2.00	50.00	40.00	1.00
626105-0255-051	2.00	51.00	41.00	1.50
626105-0255-052	2.00	52.00	42.00	1.50
626105-0255-053	2.00	53.00	43.00	1.50
626105-0255-054	2.00	54.00	44.00	1.50
626105-0255-055	2.00	55.00	45.00	1.50
626105-0255-056	2.00	56.00	46.00	1.50
626105-0255-057	2.00	57.00	47.00	1.50
626115-0203-058	2.00	58.00	48.00	1.50
626105-0255-059	2.00	59.00	49.00	1.50
626105-0255-060	2.00	60.00	50.00	1.50
626115-0201-061	2.00	61.00	51.00	1.50
626105-0255-062	2.00	62.00	52.00	1.50
626105-0255-063	2.00	63.00	53.00	1.50
626105-0255-064	2.00	64.00	54.00	1.50
626105-0255-065	2.00	65.00	55.00	1.50
626115-0202-080	2.00	80.00	70.00	1.50
626115-0251-015	2.50	15.00	5.00	1.50
626115-0250-019	2.50	19.00	9.00	1.50
626115-0252-020	2.50	20.00	10.00	1.50
626115-0253-025	2.50	25.00	15.00	1.50
626115-0253-034	2.50	34.00	24.00	1.50
626115-0251-045	2.50	45.00	35.00	1.50
626115-0251-050	2.50	50.00	40.00	1.50
626105-0250-058	2.50	58.00	48.00	1.50
626115-0250-064	2.50	64.00	54.00	1.50
626115-0251-160	2.50	160.00	150.00	2.00
626105-0305-013	3.00	13.00	3.00	2.00
626105-0305-014	3.00	14.00	4.00	2.00
626105-0305-015	3.00	15.00	5.00	2.00
626105-0305-016	3.00	16.00	6.00	2.00
626105-0305-017	3.00	17.00	7.00	2.00
626105-0305-018	3.00	18.00	8.00	2.00
626105-0305-019	3.00	19.00	9.00	2.00
626115-0302-020	3.00	20.00	10.00	2.00
626105-0305-021	3.00	21.00	11.00	2.00
626105-0305-022	3.00	22.00	12.00	2.00
626105-0305-023	3.00	23.00	13.00	2.00
626105-0305-024	3.00	24.00	14.00	2.00
626115-0303-025	3.00	25.00	15.00	2.00
626105-0305-026	3.00	26.00	16.00	2.00
626105-0305-027	3.00	27.00	17.00	2.00
626105-0305-028	3.00	28.00	18.00	2.00
626105-0305-029	3.00	29.00	19.00	2.00
626105-0305-030	3.00	30.00	20.00	2.00
626115-0301-030	3.00	30.00	20.00	1.50
626105-0305-031	3.00	31.00	21.00	2.00
626105-0305-032	3.00	32.00	22.00	2.00



Article-No.	DK	L	ML	DS
626115-0300-033	3.00	33.00	23.00	2.00
626115-0301-034	3.00	33.50	23.50	2.00
626105-0305-034	3.00	34.00	24.00	2.00
626115-0303-035	3.00	35.00	25.00	2.00
626105-0305-036	3.00	36.00	26.00	2.00
626105-0305-037	3.00	37.00	27.00	2.00
626115-0302-038	3.00	38.00	28.00	2.00
626105-0305-039	3.00	39.00	29.00	2.00
626115-0300-040	3.00	40.00	30.00	2.00
626105-0305-041	3.00	41.00	31.00	2.00
626105-0305-042	3.00	42.00	32.00	2.00
626105-0305-043	3.00	43.00	33.00	2.00
626105-0305-044	3.00	44.00	34.00	2.00
626105-0305-045	3.00	45.00	35.00	2.00
626105-0305-046	3.00	46.00	36.00	2.00
626105-0305-047	3.00	47.00	37.00	2.00
626105-0305-048	3.00	48.00	38.00	2.00
626105-0305-049	3.00	49.00	39.00	2.00
626115-0302-050	3.00	50.00	40.00	2.00
626105-0305-051	3.00	51.00	41.00	2.00
626105-0305-052	3.00	52.00	42.00	2.00
626105-0305-053	3.00	53.00	43.00	2.00
626105-0305-054	3.00	54.00	44.00	2.00
626105-0305-055	3.00	55.00	45.00	2.00
626115-0300-056	3.00	56.00	46.00	2.00
626105-0305-057	3.00	57.00	47.00	2.00
626115-0300-058	3.00	58.00	48.00	2.00
626105-0305-059	3.00	59.00	49.00	2.00
626115-0304-060	3.00	60.00	50.00	2.00
626105-0305-061	3.00	61.00	51.00	2.00
626105-0305-062	3.00	62.00	52.00	2.00
626105-0305-063	3.00	63.00	53.00	2.00
626115-0301-064	3.00	64.00	54.00	2.00
626105-0305-065	3.00	65.00	55.00	2.00
626105-0305-066	3.00	66.00	56.00	2.00
626105-0305-067	3.00	67.00	57.00	2.00
626105-0305-068	3.00	68.00	58.00	2.00
626105-0305-069	3.00	69.00	59.00	2.00
626115-0302-070	3.00	70.00	60.00	2.00
626105-0305-071	3.00	71.00	61.00	2.00
626105-0305-072	3.00	72.00	62.00	2.00
626105-0305-073	3.00	73.00	63.00	2.00
626105-0305-074	3.00	74.00	64.00	2.00
626115-0302-075	3.00	75.00	65.00	2.00
626105-0305-076	3.00	76.00	66.00	2.00
626105-0305-077	3.00	77.00	67.00	2.00
626105-0305-079	3.00	79.00	69.00	2.00
626115-0304-080	3.00	80.00	70.00	2.00
626105-0305-081	3.00	81.00	71.00	2.00
626105-0305-082	3.00	82.00	72.00	2.00
626105-0305-083	3.00	83.00	73.00	2.00



Article-No.	DK	L	ML	DS
626105-0305-084	3.00	84.00	74.00	2.00
626115-0301-085	3.00	85.00	75.00	2.00
626105-0305-086	3.00	86.00	76.00	2.00
626105-0305-087	3.00	87.00	77.00	2.00
626105-0305-088	3.00	88.00	78.00	2.00
626105-0305-089	3.00	89.00	79.00	2.00
626115-0303-090	3.00	90.00	80.00	2.00
626105-0305-091	3.00	91.00	81.00	2.00
626105-0305-092	3.00	92.00	82.00	2.00
626105-0305-093	3.00	93.00	83.00	2.00
626105-0305-094	3.00	94.00	84.00	2.00
626115-0303-095	3.00	95.00	85.00	2.00
626105-0305-096	3.00	96.00	86.00	2.00
626105-0305-097	3.00	97.00	87.00	2.00
626105-0305-098	3.00	98.00	88.00	2.00
626105-0305-099	3.00	99.00	89.00	2.00
626115-0307-100	3.00	100.00	90.00	2.00
626115-0306-105	3.00	105.00	95.00	2.00
626115-0303-115	3.00	115.00	104.00	2.00
626115-0302-120	3.00	120.00	110.00	2.00
626115-0302-130	3.00	130.00	120.00	2.50
626115-0300-135	3.00	135.00	125.00	2.50
626115-0301-135	3.00	135.00	125.00	2.00
626115-0301-155	3.00	155.00	145.00	2.00
626115-0351-064	3.50	64.00	54.00	2.00
626115-0351-075	3.50	75.00	65.00	2.50
626115-0350-090	3.50	90.00	80.00	2.50
626115-0352-100	3.50	100.00	85.00	2.50
626115-0351-125	3.50	125.00	115.00	2.50
626115-0350-135	3.50	135.00	125.00	2.00
626105-0405-014	4.00	14.00	4.00	2.00
626105-0465-014	4.00	14.00	4.00	2.50
626105-0405-015	4.00	15.00	5.00	2.00
626105-0465-015	4.00	15.00	5.00	2.50
626105-0405-016	4.00	16.00	6.00	2.00
626105-0465-016	4.00	16.00	6.00	2.50
626105-0405-017	4.00	17.00	7.00	2.00
626105-0465-017	4.00	17.00	7.00	2.50
626105-0405-018	4.00	18.00	8.00	2.00
626105-0465-018	4.00	18.00	8.00	2.50
626105-0405-019	4.00	19.00	9.00	2.00
626105-0465-019	4.00	19.00	9.00	2.50
626105-0465-020	4.00	20.00	10.00	2.50
626115-0404-020	4.00	20.00	10.00	2.00
626105-0405-021	4.00	21.00	11.00	2.00
626105-0465-021	4.00	21.00	11.00	2.50
626105-0405-022	4.00	22.00	12.00	2.00
626105-0465-022	4.00	22.00	12.00	2.50
626105-0465-023	4.00	23.00	13.00	2.50
626115-0400-023	4.00	23.00	13.00	2.00
626105-0405-024	4.00	24.00	14.00	2.00
626105-0465-024	4.00	24.00	14.00	2.50
626105-0405-025	4.00	25.00	15.00	2.00
626105-0465-025	4.00	25.00	15.00	2.50



Article-No.	DK	L	ML	DS
626105-0405-026	4.00	26.00	16.00	2.00
626105-0465-026	4.00	26.00	16.00	2.50
626105-0405-027	4.00	27.00	17.00	2.00
626105-0465-027	4.00	27.00	17.00	2.50
626105-0405-028	4.00	28.00	18.00	2.00
626105-0465-028	4.00	28.00	18.00	2.50
626105-0405-029	4.00	29.00	19.00	2.00
626105-0465-029	4.00	29.00	19.00	2.50
626105-0465-030	4.00	30.00	20.00	2.50
626115-0404-030	4.00	30.00	20.00	2.00
626105-0405-031	4.00	31.00	21.00	2.00
626105-0465-031	4.00	31.00	21.00	2.50
626105-0405-032	4.00	32.00	22.00	2.00
626105-0465-032	4.00	32.00	22.00	2.50
626105-0465-033	4.00	33.00	23.00	2.50
626115-0400-033	4.00	33.00	23.00	2.00
626115-0400-034	4.00	33.50	23.50	2.00
626105-0405-034	4.00	34.00	24.00	2.00
626105-0465-034	4.00	34.00	24.00	2.50
626105-0405-035	4.00	35.00	25.00	2.00
626105-0465-035	4.00	35.00	25.00	2.50
626105-0405-036	4.00	36.00	26.00	2.00
626105-0465-036	4.00	36.00	26.00	2.50
626105-0405-037	4.00	37.00	27.00	2.00
626105-0465-037	4.00	37.00	27.00	2.50
626105-0405-038	4.00	38.00	28.00	2.00
626105-0465-038	4.00	38.00	28.00	2.50
626105-0405-039	4.00	39.00	29.00	2.00
626105-0465-039	4.00	39.00	29.00	2.50
626105-0465-040	4.00	40.00	30.00	2.50
626115-0401-040	4.00	40.00	30.00	2.00
626105-0405-041	4.00	41.00	31.00	2.00
626105-0465-041	4.00	41.00	31.00	2.50
626105-0405-042	4.00	42.00	32.00	2.00
626105-0465-042	4.00	42.00	32.00	2.50
626105-0405-043	4.00	43.00	33.00	2.00
626105-0465-043	4.00	43.00	33.00	2.50
626105-0405-044	4.00	44.00	34.00	2.00
626105-0465-044	4.00	44.00	34.00	2.50
626105-0405-045	4.00	45.00	35.00	2.00
626105-0465-045	4.00	45.00	35.00	2.50
626105-0405-046	4.00	46.00	36.00	2.00
626105-0465-046	4.00	46.00	36.00	2.50
626105-0405-047	4.00	47.00	37.00	2.00
626105-0465-047	4.00	47.00	37.00	2.50
626105-0405-048	4.00	48.00	38.00	2.00
626105-0465-048	4.00	48.00	38.00	2.50
626105-0405-049	4.00	49.00	39.00	2.00
626105-0465-049	4.00	49.00	39.00	2.50
626115-0403-050	4.00	50.00	40.00	2.00
626115-0401-050	4.00	50.00	40.00	2.50





Article-No.	DK	L	ML	DS
626105-0405-051	4.00	51.00	41.00	2.00
626105-0465-051	4.00	51.00	41.00	2.50
626105-0405-052	4.00	52.00	42.00	2.00
626105-0465-052	4.00	52.00	42.00	2.50
626105-0405-053	4.00	53.00	43.00	2.00
626105-0465-053	4.00	53.00	43.00	2.50
626105-0405-054	4.00	54.00	44.00	2.00
626105-0465-054	4.00	54.00	44.00	2.50
626105-0405-055	4.00	55.00	45.00	2.00
626105-0465-055	4.00	55.00	45.00	2.50
626115-0401-055	4.00	55.00	45.00	3.00
626105-0405-056	4.00	56.00	46.00	2.00
626105-0465-056	4.00	56.00	46.00	2.50
626105-0405-057	4.00	57.00	47.00	2.00
626105-0465-057	4.00	57.00	47.00	2.50
626115-0400-058	4.00	58.00	48.00	2.50
626115-0402-058	4.00	58.00	48.00	2.00
626105-0405-059	4.00	59.00	49.00	2.00
626105-0465-059	4.00	59.00	49.00	2.50
626105-0405-060	4.00	60.00	50.00	2.00
626115-0402-060	4.00	60.00	50.00	2.50
626105-0465-061	4.00	61.00	51.00	2.50
626105-0405-061	4.00	61.00	51.00	2.00
626105-0465-062	4.00	62.00	52.00	2.50
626105-0405-062	4.00	62.00	52.00	2.00
626105-0465-063	4.00	63.00	53.00	2.50
626105-0405-063	4.00	63.00	53.00	2.00
626115-0405-064	4.00	64.00	54.00	2.00
626115-0401-064	4.00	64.00	54.00	2.50
626105-0405-065	4.00	65.00	55.00	2.00
626115-0400-065	4.00	65.00	55.00	2.50
626105-0465-066	4.00	66.00	56.00	2.50
626105-0405-066	4.00	66.00	56.00	2.00
626105-0465-067	4.00	67.00	57.00	2.50
626105-0405-067	4.00	67.00	57.00	2.00
626105-0465-068	4.00	68.00	58.00	2.50
626105-0405-068	4.00	68.00	58.00	2.00
626105-0465-069	4.00	69.00	59.00	2.50
626105-0405-069	4.00	69.00	59.00	2.00
626105-0465-070	4.00	70.00	60.00	2.50
626115-0401-070	4.00	70.00	60.00	2.00
626105-0465-071	4.00	71.00	61.00	2.50
626105-0405-071	4.00	71.00	61.00	2.00
626105-0465-072	4.00	72.00	62.00	2.50
626105-0405-072	4.00	72.00	62.00	2.00
626105-0465-073	4.00	73.00	63.00	2.50
626105-0405-073	4.00	73.00	63.00	2.00
626105-0465-074	4.00	74.00	64.00	2.50
626105-0405-074	4.00	74.00	64.00	2.00
626115-0404-075	4.00	75.00	65.00	2.50
626115-0402-075	4.00	75.00	65.00	2.00
626105-0465-076	4.00	76.00	66.00	2.50
626105-0405-076	4.00	76.00	66.00	2.00
626105-0465-077	4.00	77.00	67.00	2.50



Article-No.	DK	L	ML	DS
626105-0405-077	4.00	77.00	67.00	2.00
626105-0465-078	4.00	78.00	68.00	2.50
626105-0405-078	4.00	78.00	68.00	2.00
626105-0465-079	4.00	79.00	69.00	2.50
626105-0405-079	4.00	79.00	69.00	2.00
626105-0465-080	4.00	80.00	70.00	2.50
626105-0405-080	4.00	80.00	70.00	2.00
626115-0404-080	4.00	80.00	70.00	3.00
626105-0465-081	4.00	81.00	71.00	2.50
626105-0405-081	4.00	81.00	71.00	2.00
626105-0465-082	4.00	82.00	72.00	2.50
626105-0405-082	4.00	82.00	72.00	2.00
626105-0465-083	4.00	83.00	73.00	2.50
626105-0405-083	4.00	83.00	73.00	2.00
626105-0465-084	4.00	84.00	74.00	2.50
626105-0405-084	4.00	84.00	74.00	2.00
626105-0465-085	4.00	85.00	75.00	2.50
626105-0405-085	4.00	85.00	75.00	2.00
626115-0400-085	4.00	85.00	75.00	3.00
626105-0465-086	4.00	86.00	76.00	2.50
626105-0405-086	4.00	86.00	76.00	2.00
626105-0465-087	4.00	87.00	77.00	2.50
626105-0405-087	4.00	87.00	77.00	2.00
626105-0465-088	4.00	88.00	78.00	2.50
626105-0405-088	4.00	88.00	78.00	2.00
626105-0465-089	4.00	89.00	79.00	2.50
626105-0405-089	4.00	89.00	79.00	2.00
626115-0405-090	4.00	90.00	80.00	2.00
626115-0402-090	4.00	90.00	80.00	2.50
626105-0465-091	4.00	91.00	81.00	2.50
626105-0405-091	4.00	91.00	81.00	2.00
626115-0401-092	4.00	92.00	82.00	2.50
626105-0405-092	4.00	92.00	82.00	2.00
626105-0465-093	4.00	93.00	83.00	2.50
626105-0405-093	4.00	93.00	83.00	2.00
626105-0465-094	4.00	94.00	84.00	2.50
626105-0405-094	4.00	94.00	84.00	2.00
626105-0465-095	4.00	95.00	85.00	2.50
626105-0405-095	4.00	95.00	85.00	2.00
626105-0465-096	4.00	96.00	86.00	2.50
626105-0405-096	4.00	96.00	86.00	2.00
626105-0465-097	4.00	97.00	87.00	2.50
626105-0405-097	4.00	97.00	87.00	2.00
626105-0465-098	4.00	98.00	88.00	2.50
626105-0405-098	4.00	98.00	88.00	2.00
626105-0465-099	4.00	99.00	89.00	2.50
626105-0405-099	4.00	99.00	89.00	2.00
626115-0402-100	4.00	100.00	90.00	2.50
626105-0405-100	4.00	100.00	90.00	2.00
626115-0405-100	4.00	100.00	90.00	3.00
626105-0465-101	4.00	101.00	91.00	2.50



Article-No.	DK	L	ML	DS
626105-0405-101	4.00	101.00	91.00	2.00
626105-0465-102	4.00	102.00	92.00	2.50
626105-0405-102	4.00	102.00	92.00	2.00
626105-0465-103	4.00	103.00	93.00	2.50
626105-0405-103	4.00	103.00	93.00	2.00
626105-0465-104	4.00	104.00	94.00	2.50
626105-0405-104	4.00	104.00	94.00	2.00
626115-0401-105	4.00	105.00	95.00	2.00
626105-0465-105	4.00	105.00	95.00	2.50
626105-0465-106	4.00	106.00	96.00	2.50
626105-0405-106	4.00	106.00	96.00	2.00
626105-0465-107	4.00	107.00	97.00	2.50
626105-0405-107	4.00	107.00	97.00	2.00
626105-0465-108	4.00	108.00	98.00	2.50
626105-0405-108	4.00	108.00	98.00	2.00
626105-0465-109	4.00	109.00	99.00	2.50
626105-0405-109	4.00	109.00	99.00	2.00
626115-0403-110	4.00	110.00	100.00	2.00
626115-0402-110	4.00	110.00	100.00	2.50
626105-0465-111	4.00	111.00	101.00	2.50
626105-0405-111	4.00	111.00	101.00	2.00
626105-0465-112	4.00	112.00	102.00	2.50
626105-0405-112	4.00	112.00	102.00	2.00
626105-0465-113	4.00	113.00	103.00	2.50
626105-0405-113	4.00	113.00	103.00	2.00
626105-0465-114	4.00	114.00	104.00	2.50
626105-0405-114	4.00	114.00	104.00	2.00
626105-0465-115	4.00	115.00	105.00	2.50
626105-0405-115	4.00	115.00	105.00	2.00
626105-0465-116	4.00	116.00	106.00	2.50
626105-0405-116	4.00	116.00	106.00	2.00
626105-0465-117	4.00	117.00	107.00	2.50
626105-0405-117	4.00	117.00	107.00	2.00
626105-0465-118	4.00	118.00	108.00	2.50
626105-0405-118	4.00	118.00	108.00	2.00
626105-0465-119	4.00	119.00	109.00	2.50
626105-0405-119	4.00	119.00	109.00	2.00
626115-0405-120	4.00	120.00	110.00	3.00
626115-0401-120	4.00	120.00	110.00	2.50
626105-0405-120	4.00	120.00	110.00	2.00
626105-0465-121	4.00	121.00	111.00	2.50
626105-0405-121	4.00	121.00	111.00	2.00
626105-0465-122	4.00	122.00	112.00	2.50
626105-0405-122	4.00	122.00	112.00	2.00
626105-0465-123	4.00	123.00	113.00	2.50
626105-0405-123	4.00	123.00	113.00	2.00
626105-0465-124	4.00	124.00	114.00	2.50
626105-0405-124	4.00	124.00	114.00	2.00
626115-0402-125	4.00	125.00	115.00	2.50
626105-0405-125	4.00	125.00	115.00	2.00
626105-0465-126	4.00	126.00	116.00	2.50
626105-0405-126	4.00	126.00	116.00	2.00
626105-0465-127	4.00	127.00	117.00	2.50
626105-0405-127	4.00	127.00	117.00	2.00



Article-No.	DK	L	ML	DS
626105-0465-128	4.00	128.00	118.00	2.50
626105-0405-128	4.00	128.00	118.00	2.00
626105-0405-129	4.00	129.00	119.00	2.00
626105-0465-129	4.00	129.00	119.00	2.50
626105-0405-130	4.00	130.00	120.00	2.00
626115-0403-130	4.00	130.00	120.00	2.50
626105-0465-131	4.00	131.00	121.00	2.50
626105-0465-132	4.00	132.00	122.00	2.50
626105-0465-133	4.00	133.00	123.00	2.50
626105-0465-134	4.00	134.00	124.00	2.50
626105-0465-135	4.00	135.00	125.00	2.50
626115-0402-135	4.00	135.00	125.00	3.00
626115-0400-140	4.00	140.00	130.00	3.00
626115-0402-150	4.00	150.00	140.00	3.00
626115-0401-160	4.00	160.00	150.00	3.00
626105-0515-015	5.00	15.00	5.00	3.50
626105-0515-016	5.00	16.00	6.00	3.50
626105-0515-017	5.00	17.00	7.00	3.50
626105-0515-018	5.00	18.00	8.00	3.50
626105-0515-019	5.00	19.00	9.00	3.50
626115-0504-020	5.00	20.00	10.00	3.50
626105-0515-021	5.00	21.00	11.00	3.50
626105-0515-022	5.00	22.00	12.00	3.50
626105-0515-023	5.00	23.00	13.00	3.50
626105-0515-024	5.00	24.00	14.00	3.50
626105-0515-025	5.00	25.00	15.00	3.50
626105-0515-026	5.00	26.00	16.00	3.50
626105-0515-027	5.00	27.00	17.00	3.50
626105-0515-028	5.00	28.00	18.00	3.50
626105-0515-029	5.00	29.00	19.00	3.50
626115-0501-030	5.00	30.00	20.00	3.50
626105-0515-031	5.00	31.00	21.00	3.50
626105-0515-032	5.00	32.00	22.00	3.50
626105-0515-033	5.00	33.00	23.00	3.50
626115-0502-033	5.00	33.00	23.00	3.00
626105-0515-034	5.00	34.00	24.00	3.50
626105-0515-035	5.00	35.00	25.00	3.50
626105-0515-036	5.00	36.00	26.00	3.50
626105-0515-037	5.00	37.00	27.00	3.50
626105-0515-038	5.00	38.00	28.00	3.50
626105-0515-039	5.00	39.00	29.00	3.50
626115-0506-040	5.00	40.00	30.00	3.50
626105-0515-041	5.00	41.00	31.00	3.50
626105-0515-042	5.00	42.00	32.00	3.50
626105-0515-043	5.00	43.00	33.00	3.50
626105-0515-044	5.00	44.00	34.00	3.50
626105-0515-045	5.00	45.00	35.00	3.50
626105-0515-046	5.00	46.00	36.00	3.50
626105-0515-047	5.00	47.00	37.00	3.50
626105-0515-048	5.00	48.00	38.00	3.50
626105-0515-049	5.00	49.00	39.00	3.50



Article-No.	DK	L	ML	DS
626115-0501-050	5.00	50.00	40.00	3.50
626105-0515-051	5.00	51.00	41.00	3.50
626105-0515-052	5.00	52.00	42.00	3.50
626115-0501-053	5.00	53.00	40.00	3.50
626105-0500-053	5.00	53.00	43.00	3.50
626105-0515-054	5.00	54.00	44.00	3.50
626115-0502-055	5.00	55.00	45.00	2.50
626105-0515-055	5.00	55.00	45.00	3.50
626105-0515-056	5.00	56.00	46.00	3.50
626105-0515-057	5.00	57.00	47.00	3.50
626105-0515-058	5.00	58.00	48.00	3.50
626105-0515-059	5.00	59.00	49.00	3.50
626105-0515-060	5.00	60.00	50.00	3.50
626105-0515-061	5.00	61.00	51.00	3.50
626105-0515-062	5.00	62.00	52.00	3.50
626105-0515-063	5.00	63.00	53.00	3.50
626105-0515-064	5.00	64.00	54.00	3.50
626105-0515-065	5.00	65.00	55.00	3.50
626105-0515-066	5.00	66.00	56.00	3.50
626105-0515-067	5.00	67.00	57.00	3.50
626105-0515-068	5.00	68.00	58.00	3.50
626105-0515-069	5.00	69.00	59.00	3.50
626105-0515-070	5.00	70.00	60.00	3.50
626105-0515-071	5.00	71.00	61.00	3.50
626105-0515-072	5.00	72.00	62.00	3.50
626105-0515-073	5.00	73.00	63.00	3.50
626105-0515-074	5.00	74.00	64.00	3.50
626115-0500-075	5.00	75.00	65.00	3.50
626105-0515-076	5.00	76.00	66.00	3.50
626105-0515-077	5.00	77.00	67.00	3.50
626105-0515-078	5.00	78.00	68.00	3.50
626105-0515-079	5.00	79.00	69.00	3.50
626115-0506-080	5.00	80.00	70.00	3.50
626105-0515-081	5.00	81.00	71.00	3.50
626105-0515-082	5.00	82.00	72.00	3.50
626105-0515-083	5.00	83.00	73.00	3.50
626105-0515-084	5.00	84.00	74.00	3.50
626105-0515-085	5.00	85.00	75.00	3.50
626105-0515-086	5.00	86.00	76.00	3.50
626105-0515-087	5.00	87.00	77.00	3.50
626105-0515-088	5.00	88.00	78.00	3.50
626105-0515-089	5.00	89.00	79.00	3.50
626115-0501-090	5.00	90.00	80.00	3.50
626105-0515-091	5.00	91.00	81.00	3.50
626105-0515-092	5.00	92.00	82.00	3.50
626105-0515-093	5.00	93.00	83.00	3.50
626105-0515-094	5.00	94.00	84.00	3.50
626105-0515-095	5.00	95.00	85.00	3.50
626105-0515-096	5.00	96.00	86.00	3.50
626105-0515-097	5.00	97.00	87.00	3.50
626105-0515-098	5.00	98.00	88.00	3.50
626105-0515-099	5.00	99.00	89.00	3.50
626115-0501-100	5.00	100.00	90.00	3.50
626105-0515-101	5.00	101.00	91.00	3.50



Article-No.	DK	L	ML	DS
626105-0515-102	5.00	102.00	92.00	3.50
626105-0515-103	5.00	103.00	93.00	3.50
626105-0515-104	5.00	104.00	94.00	3.50
626115-0502-105	5.00	105.00	95.00	3.50
626105-0515-106	5.00	106.00	96.00	3.50
626105-0515-107	5.00	107.00	97.00	3.50
626105-0515-108	5.00	108.00	98.00	3.50
626105-0515-109	5.00	109.00	99.00	3.50
626115-0501-110	5.00	110.00	100.00	3.50
626115-0503-110	5.00	110.00	100.00	3.00
626105-0515-111	5.00	111.00	101.00	3.50
626105-0515-112	5.00	112.00	102.00	3.50
626105-0515-113	5.00	113.00	103.00	3.50
626105-0515-114	5.00	114.00	104.00	3.50
626115-0502-115	5.00	115.00	105.00	3.50
626105-0515-116	5.00	116.00	106.00	3.50
626105-0515-117	5.00	117.00	107.00	3.50
626105-0515-118	5.00	118.00	108.00	3.50
626105-0515-119	5.00	119.00	109.00	3.50
626115-0502-120	5.00	120.00	110.00	3.50
626105-0515-121	5.00	121.00	111.00	3.50
626105-0515-122	5.00	122.00	112.00	3.50
626105-0515-123	5.00	123.00	113.00	3.50
626115-0501-124	5.00	124.00	114.00	3.50
626115-0503-125	5.00	125.00	115.00	3.50
626105-0515-126	5.00	126.00	116.00	3.50
626105-0515-127	5.00	127.00	117.00	3.50
626105-0515-128	5.00	128.00	118.00	3.50
626105-0515-129	5.00	129.00	119.00	3.50
626105-0515-130	5.00	130.00	120.00	3.50
626115-0501-131	5.00	131.00	121.00	3.50
626105-0515-132	5.00	132.00	122.00	3.50
626105-0515-133	5.00	133.00	123.00	3.50
626105-0515-134	5.00	134.00	124.00	3.50
626105-0515-135	5.00	135.00	125.00	3.50
626105-0515-136	5.00	136.00	126.00	3.50
626105-0515-137	5.00	137.00	127.00	3.50
626105-0515-138	5.00	138.00	128.00	3.50
626105-0515-139	5.00	139.00	129.00	3.50
626115-0501-140	5.00	140.00	130.00	3.50
626115-0502-140	5.00	140.00	125.00	3.50
626105-0515-141	5.00	141.00	131.00	3.50
626105-0515-142	5.00	142.00	132.00	3.50
626105-0515-143	5.00	143.00	133.00	3.50
626105-0515-144	5.00	144.00	134.00	3.50
626115-0501-145	5.00	145.00	135.00	3.50
626105-0515-146	5.00	146.00	136.00	3.50
626105-0515-147	5.00	147.00	137.00	3.50
626105-0515-148	5.00	148.00	138.00	3.50
626105-0515-149	5.00	149.00	139.00	3.50
626115-0501-150	5.00	150.00	140.00	3.50



Article-No.	DK	L	ML	DS
626105-0515-151	5.00	151.00	141.00	3.50
626105-0515-152	5.00	152.00	142.00	3.50
626105-0515-153	5.00	153.00	143.00	3.50
626105-0515-154	5.00	154.00	144.00	3.50
626105-0515-155	5.00	155.00	145.00	3.50
626105-0515-156	5.00	156.00	146.00	3.50
626105-0515-157	5.00	157.00	147.00	3.50
626105-0515-158	5.00	158.00	148.00	3.50
626105-0515-159	5.00	159.00	149.00	3.50
626115-0501-160	5.00	160.00	150.00	3.50
626105-0515-161	5.00	161.00	151.00	3.50
626105-0515-162	5.00	162.00	152.00	3.50
626105-0515-163	5.00	163.00	153.00	3.50
626105-0515-164	5.00	164.00	154.00	3.50
626105-0515-165	5.00	165.00	155.00	3.50
626105-0515-166	5.00	166.00	156.00	3.50
626105-0515-167	5.00	167.00	157.00	3.50
626105-0515-168	5.00	168.00	158.00	3.50
626105-0515-169	5.00	169.00	159.00	3.50
626105-0515-170	5.00	170.00	160.00	3.50
626105-0515-171	5.00	171.00	161.00	3.50
626105-0515-172	5.00	172.00	162.00	3.50
626105-0515-173	5.00	173.00	163.00	3.50
626105-0515-174	5.00	174.00	164.00	3.50
626105-0515-175	5.00	175.00	165.00	3.50
626115-0501-175	5.00	175.00	155.00	3.50
626105-0515-176	5.00	176.00	166.00	3.50
626105-0515-177	5.00	177.00	167.00	3.50
626115-0500-178	5.00	177.50	167.50	3.50
626105-0515-178	5.00	178.00	168.00	3.50
626105-0515-179	5.00	179.00	169.00	3.50
626105-0515-180	5.00	180.00	170.00	3.50
626105-0515-181	5.00	181.00	171.00	3.50
626105-0515-182	5.00	182.00	172.00	3.50
626105-0515-183	5.00	183.00	173.00	3.50
626105-0515-184	5.00	184.00	174.00	3.50
626105-0515-185	5.00	185.00	175.00	3.50
626105-0515-186	5.00	186.00	176.00	3.50
626105-0515-187	5.00	187.00	177.00	3.50
626105-0515-188	5.00	188.00	178.00	3.50
626105-0515-189	5.00	189.00	179.00	3.50
626115-0601-025	6.00	25.00	15.00	2.00
626115-0601-030	6.00	30.00	20.00	2.00
626105-0615-035	6.00	35.00	25.00	3.50
626105-0615-036	6.00	36.00	26.00	3.50
626105-0615-037	6.00	37.00	27.00	3.50
626105-0615-038	6.00	38.00	28.00	3.50
626105-0615-039	6.00	39.00	29.00	3.50
626105-0615-040	6.00	40.00	30.00	3.50
626105-0615-041	6.00	41.00	31.00	3.50
626105-0615-042	6.00	42.00	32.00	3.50
626105-0615-043	6.00	43.00	33.00	3.50
626105-0615-044	6.00	44.00	34.00	3.50
626105-0615-045	6.00	45.00	35.00	3.50



Article-No.	DK	L	ML	DS
626105-0615-046	6.00	46.00	36.00	3.50
626105-0615-047	6.00	47.00	37.00	3.50
626105-0615-048	6.00	48.00	38.00	3.50
626105-0615-049	6.00	49.00	39.00	3.50
626105-0615-050	6.00	50.00	40.00	3.50
626115-0603-050	6.00	50.00	40.00	4.00
626105-0615-051	6.00	51.00	41.00	3.50
626105-0615-052	6.00	52.00	42.00	3.50
626105-0615-053	6.00	53.00	43.00	3.50
626105-0615-054	6.00	54.00	44.00	3.50
626105-0615-055	6.00	55.00	45.00	3.50
626105-0615-056	6.00	56.00	46.00	3.50
626105-0615-057	6.00	57.00	47.00	3.50
626105-0615-058	6.00	58.00	48.00	3.50
626105-0615-059	6.00	59.00	49.00	3.50
626105-0615-060	6.00	60.00	50.00	3.50
626105-0615-061	6.00	61.00	51.00	3.50
626105-0615-062	6.00	62.00	52.00	3.50
626105-0615-063	6.00	63.00	53.00	3.50
626105-0615-064	6.00	64.00	54.00	3.50
626105-0615-065	6.00	65.00	55.00	3.50
626105-0615-066	6.00	66.00	56.00	3.50
626105-0615-067	6.00	67.00	57.00	3.50
626115-0601-068	6.00	68.00	58.00	3.50
626105-0615-069	6.00	69.00	59.00	3.50
626105-0615-070	6.00	70.00	60.00	3.50
626105-0615-071	6.00	71.00	61.00	3.50
626105-0615-072	6.00	72.00	62.00	3.50
626105-0615-073	6.00	73.00	63.00	3.50
626105-0615-074	6.00	74.00	64.00	3.50
626105-0615-075	6.00	75.00	65.00	3.50
626105-0615-076	6.00	76.00	66.00	3.50
626105-0615-077	6.00	77.00	67.00	3.50
626105-0615-078	6.00	78.00	68.00	3.50
626105-0615-079	6.00	79.00	69.00	3.50
626105-0615-080	6.00	80.00	70.00	3.50
626105-0615-081	6.00	81.00	71.00	3.50
626105-0615-082	6.00	82.00	72.00	3.50
626105-0615-083	6.00	83.00	73.00	3.50
626105-0615-084	6.00	84.00	74.00	3.50
626105-0615-085	6.00	85.00	75.00	3.50
626115-0600-085	6.00	85.00	75.00	4.00
626105-0615-086	6.00	86.00	76.00	3.50
626105-0615-087	6.00	87.00	77.00	3.50
626105-0615-088	6.00	88.00	78.00	3.50
626105-0615-089	6.00	89.00	79.00	3.50
626105-0615-090	6.00	90.00	80.00	3.50
626105-0615-091	6.00	91.00	81.00	3.50
626105-0615-092	6.00	92.00	82.00	3.50
626105-0615-093	6.00	93.00	83.00	3.50
626105-0615-094	6.00	94.00	84.00	3.50





Article-No.	DK	L	ML	DS
626105-0615-095	6.00	95.00	85.00	3.50
626105-0615-096	6.00	96.00	86.00	3.50
626105-0615-097	6.00	97.00	87.00	3.50
626105-0615-098	6.00	98.00	88.00	3.50
626105-0615-099	6.00	99.00	89.00	3.50
626105-0615-100	6.00	100.00	90.00	3.50
626105-0615-101	6.00	101.00	91.00	3.50
626105-0615-102	6.00	102.00	92.00	3.50
626105-0615-103	6.00	103.00	93.00	3.50
626105-0615-104	6.00	104.00	94.00	3.50
626115-0600-105	6.00	105.00	92.00	5.00
626105-0615-105	6.00	105.00	95.00	3.50
626105-0615-106	6.00	106.00	96.00	3.50
626105-0615-107	6.00	107.00	97.00	3.50
626105-0615-108	6.00	108.00	98.00	3.50
626105-0615-109	6.00	109.00	99.00	3.50
626115-0602-110	6.00	110.00	100.00	3.50
626105-0615-111	6.00	111.00	101.00	3.50
626105-0615-112	6.00	112.00	102.00	3.50
626105-0615-113	6.00	113.00	103.00	3.50
626105-0615-114	6.00	114.00	104.00	3.50
626105-0615-115	6.00	115.00	105.00	3.50
626105-0615-116	6.00	116.00	106.00	3.50
626105-0615-117	6.00	117.00	107.00	3.50
626105-0615-118	6.00	118.00	108.00	3.50
626105-0615-119	6.00	119.00	109.00	3.50
626105-0615-120	6.00	120.00	110.00	3.50
626105-0615-121	6.00	121.00	111.00	3.50
626105-0615-122	6.00	122.00	112.00	3.50
626105-0615-123	6.00	123.00	113.00	3.50
626105-0615-124	6.00	124.00	114.00	3.50
626105-0615-125	6.00	125.00	115.00	3.50
626105-0615-126	6.00	126.00	116.00	3.50
626105-0615-127	6.00	127.00	117.00	3.50
626115-0601-128	6.00	128.00	118.00	3.50
626105-0615-128	6.00	128.00	118.00	3.50
626105-0615-129	6.00	129.00	119.00	3.50
626105-0615-130	6.00	130.00	120.00	3.50
626105-0615-131	6.00	131.00	121.00	3.50
626105-0615-132	6.00	132.00	122.00	3.50
626105-0615-133	6.00	133.00	123.00	3.50
626105-0615-134	6.00	134.00	124.00	3.50
626105-0615-135	6.00	135.00	125.00	3.50
626105-0615-136	6.00	136.00	126.00	3.50
626105-0615-137	6.00	137.00	127.00	3.50
626105-0615-138	6.00	138.00	128.00	3.50
626105-0615-139	6.00	139.00	129.00	3.50
626105-0615-140	6.00	140.00	130.00	3.50
626105-0615-141	6.00	141.00	131.00	3.50
626105-0615-142	6.00	142.00	132.00	3.50
626105-0615-143	6.00	143.00	133.00	3.50
626105-0615-144	6.00	144.00	134.00	3.50
626115-0601-145	6.00	145.00	135.00	3.50
626105-0615-146	6.00	146.00	136.00	3.50



Article-No.	DK	L	ML	DS
626105-0615-147	6.00	147.00	137.00	3.50
626105-0615-148	6.00	148.00	138.00	3.50
626105-0615-149	6.00	149.00	139.00	3.50
626115-0601-150	6.00	150.00	140.00	3.50
626105-0615-151	6.00	151.00	141.00	3.50
626105-0615-152	6.00	152.00	142.00	3.50
626105-0615-153	6.00	153.00	143.00	3.50
626105-0615-154	6.00	154.00	144.00	3.50
626105-0615-155	6.00	155.00	145.00	3.50
626105-0615-156	6.00	156.00	146.00	3.50
626105-0615-157	6.00	157.00	147.00	3.50
626105-0615-158	6.00	158.00	148.00	3.50
626105-0615-159	6.00	159.00	149.00	3.50
626105-0615-160	6.00	160.00	150.00	3.50
626105-0615-161	6.00	161.00	151.00	3.50
626105-0615-162	6.00	162.00	152.00	3.50
626105-0615-163	6.00	163.00	153.00	3.50
626105-0615-164	6.00	164.00	154.00	3.50
626105-0615-165	6.00	165.00	155.00	3.50
626105-0615-166	6.00	166.00	156.00	3.50
626105-0615-167	6.00	167.00	157.00	3.50
626105-0615-168	6.00	168.00	158.00	3.50
626105-0615-169	6.00	169.00	159.00	3.50
626105-0615-170	6.00	170.00	160.00	3.50
626105-0615-171	6.00	171.00	161.00	3.50
626105-0615-172	6.00	172.00	162.00	3.50
626105-0615-173	6.00	173.00	163.00	3.50
626105-0615-174	6.00	174.00	164.00	3.50
626115-0602-175	6.00	175.00	155.00	3.50
626105-0615-175	6.00	175.00	165.00	3.50
626105-0615-176	6.00	176.00	166.00	3.50
626105-0615-177	6.00	177.00	167.00	3.50
626105-0615-178	6.00	178.00	168.00	3.50
626105-0615-179	6.00	179.00	169.00	3.50
626105-0615-180	6.00	180.00	170.00	3.50
626105-0615-181	6.00	181.00	171.00	3.50
626105-0615-182	6.00	182.00	172.00	3.50
626105-0615-183	6.00	183.00	173.00	3.50
626105-0615-184	6.00	184.00	174.00	3.50
626105-0615-185	6.00	185.00	175.00	3.50
626105-0615-186	6.00	186.00	176.00	3.50
626105-0615-187	6.00	187.00	177.00	3.50
626105-0615-188	6.00	188.00	178.00	3.50
626105-0615-189	6.00	189.00	179.00	3.50
626115-0701-025	7.00	25.00	15.00	2.00
626115-0702-055	7.00	55.00	45.00	3.50
626115-0702-120	7.00	120.00	110.00	3.50
626105-0825-035	8.00	35.00	22.00	6.00
626105-0825-036	8.00	36.00	23.00	6.00
626105-0825-037	8.00	37.00	24.00	6.00
626105-0825-038	8.00	38.00	25.00	6.00



Article-No.	DK	L	ML	DS
626115-0801-038	8.00	38.00	28.00	3.00
626105-0825-039	8.00	39.00	26.00	6.00
626105-0825-040	8.00	40.00	27.00	6.00
626105-0825-041	8.00	41.00	28.00	6.00
626105-0825-042	8.00	42.00	29.00	6.00
626105-0825-043	8.00	43.00	30.00	6.00
626105-0825-044	8.00	44.00	31.00	6.00
626105-0825-045	8.00	45.00	32.00	6.00
626105-0825-046	8.00	46.00	33.00	6.00
626105-0825-047	8.00	47.00	34.00	6.00
626105-0825-048	8.00	48.00	35.00	6.00
626105-0825-049	8.00	49.00	36.00	6.00
626105-0825-050	8.00	50.00	37.00	6.00
626105-0825-051	8.00	51.00	38.00	6.00
626105-0825-052	8.00	52.00	39.00	6.00
626105-0825-053	8.00	53.00	40.00	6.00
626105-0825-054	8.00	54.00	41.00	6.00
626105-0825-055	8.00	55.00	42.00	6.00
626115-0800-055	8.00	55.00	45.00	3.50
626105-0825-056	8.00	56.00	43.00	6.00
626105-0825-057	8.00	57.00	44.00	6.00
626105-0825-058	8.00	58.00	45.00	6.00
626105-0825-059	8.00	59.00	46.00	6.00
626105-0825-060	8.00	60.00	47.00	6.00
626105-0825-061	8.00	61.00	48.00	6.00
626105-0825-062	8.00	62.00	49.00	6.00
626105-0825-063	8.00	63.00	50.00	6.00
626115-0800-064	8.00	63.50	50.50	6.00
626105-0825-064	8.00	64.00	51.00	6.00
626105-0825-065	8.00	65.00	52.00	6.00
626105-0825-066	8.00	66.00	53.00	6.00
626105-0825-067	8.00	67.00	54.00	6.00
626105-0825-068	8.00	68.00	55.00	6.00
626105-0825-069	8.00	69.00	56.00	6.00
626105-0825-070	8.00	70.00	57.00	6.00
626105-0825-071	8.00	71.00	58.00	6.00
626105-0825-072	8.00	72.00	59.00	6.00
626105-0825-073	8.00	73.00	60.00	6.00
626105-0825-074	8.00	74.00	61.00	6.00
626105-0825-075	8.00	75.00	62.00	6.00
626105-0825-076	8.00	76.00	63.00	6.00
626105-0825-077	8.00	77.00	64.00	6.00
626105-0825-078	8.00	78.00	65.00	6.00
626105-0825-079	8.00	79.00	66.00	6.00
626105-0825-080	8.00	80.00	67.00	6.00
626105-0825-081	8.00	81.00	68.00	6.00
626105-0825-082	8.00	82.00	69.00	6.00
626105-0825-083	8.00	83.00	70.00	6.00
626105-0825-084	8.00	84.00	71.00	6.00
626105-0825-085	8.00	85.00	72.00	6.00
626105-0825-086	8.00	86.00	73.00	6.00
626105-0825-087	8.00	87.00	74.00	6.00
626105-0825-088	8.00	88.00	75.00	6.00
626105-0825-089	8.00	89.00	76.00	6.00



Article-No.	DK	L	ML	DS
626105-0825-090	8.00	90.00	77.00	6.00
626105-0825-091	8.00	91.00	78.00	6.00
626105-0825-092	8.00	92.00	79.00	6.00
626105-0825-093	8.00	93.00	80.00	6.00
626105-0825-094	8.00	94.00	81.00	6.00
626105-0825-095	8.00	95.00	82.00	6.00
626105-0825-096	8.00	96.00	83.00	6.00
626105-0825-097	8.00	97.00	84.00	6.00
626105-0825-098	8.00	98.00	85.00	6.00
626105-0825-099	8.00	99.00	86.00	6.00
626105-0825-100	8.00	100.00	87.00	6.00
626115-0801-100	8.00	100.00	88.00	5.00
626105-0825-101	8.00	101.00	88.00	6.00
626105-0825-102	8.00	102.00	89.00	6.00
626105-0825-103	8.00	103.00	90.00	6.00
626105-0825-104	8.00	104.00	91.00	6.00
626105-0825-105	8.00	105.00	92.00	6.00
626105-0825-106	8.00	106.00	93.00	6.00
626105-0825-107	8.00	107.00	94.00	6.00
626105-0825-108	8.00	108.00	95.00	6.00
626105-0825-109	8.00	109.00	96.00	6.00
626105-0825-110	8.00	110.00	97.00	6.00
626105-0825-111	8.00	111.00	98.00	6.00
626105-0825-112	8.00	112.00	99.00	6.00
626105-0825-113	8.00	113.00	100.00	6.00
626105-0825-114	8.00	114.00	101.00	6.00
626115-0800-115	8.00	114.50	101.50	6.00
626105-0825-115	8.00	115.00	102.00	6.00
626105-0825-116	8.00	116.00	103.00	6.00
626105-0825-117	8.00	117.00	104.00	6.00
626105-0825-118	8.00	118.00	105.00	6.00
626105-0825-119	8.00	119.00	106.00	6.00
626105-0825-120	8.00	120.00	107.00	6.00
626105-0825-121	8.00	121.00	108.00	6.00
626105-0825-122	8.00	122.00	109.00	6.00
626105-0825-123	8.00	123.00	110.00	6.00
626105-0825-124	8.00	124.00	111.00	6.00
626105-0825-125	8.00	125.00	112.00	6.00
626115-0801-125	8.00	125.00	112.00	5.00
626105-0825-126	8.00	126.00	113.00	6.00
626105-0825-127	8.00	127.00	114.00	6.00
626105-0825-128	8.00	128.00	115.00	6.00
626105-0825-129	8.00	129.00	116.00	6.00
626105-0825-130	8.00	130.00	117.00	6.00
626105-0825-131	8.00	131.00	118.00	6.00
626105-0825-132	8.00	132.00	119.00	6.00
626105-0825-133	8.00	133.00	120.00	6.00
626105-0825-134	8.00	134.00	121.00	6.00
626105-0825-135	8.00	135.00	122.00	6.00
626105-0825-136	8.00	136.00	123.00	6.00
626105-0825-137	8.00	137.00	124.00	6.00



Article-No.	DK	L	ML	DS
626105-0825-138	8.00	138.00	125.00	6.00
626105-0825-139	8.00	139.00	126.00	6.00
626105-0825-140	8.00	140.00	127.00	6.00
626105-0825-141	8.00	141.00	128.00	6.00
626105-0825-142	8.00	142.00	129.00	6.00
626105-0825-143	8.00	143.00	130.00	6.00
626105-0825-144	8.00	144.00	131.00	6.00
626105-0825-145	8.00	145.00	132.00	6.00
626105-0825-146	8.00	146.00	133.00	6.00
626105-0825-147	8.00	147.00	134.00	6.00
626105-0825-148	8.00	148.00	135.00	6.00
626105-0825-149	8.00	149.00	136.00	6.00
626105-0825-150	8.00	150.00	137.00	6.00
626115-0800-150	8.00	150.00	130.00	6.00
626105-0825-151	8.00	151.00	138.00	6.00
626105-0825-152	8.00	152.00	139.00	6.00
626105-0825-153	8.00	153.00	140.00	6.00
626105-0825-154	8.00	154.00	141.00	6.00
626105-0825-155	8.00	155.00	142.00	6.00
626105-0825-156	8.00	156.00	143.00	6.00
626105-0825-157	8.00	157.00	144.00	6.00
626105-0825-158	8.00	158.00	145.00	6.00
626105-0825-159	8.00	159.00	146.00	6.00
626105-0825-160	8.00	160.00	147.00	6.00
626105-0825-161	8.00	161.00	148.00	6.00
626105-0825-162	8.00	162.00	149.00	6.00
626105-0825-163	8.00	163.00	150.00	6.00
626105-0825-164	8.00	164.00	151.00	6.00
626105-0825-165	8.00	165.00	152.00	6.00
626115-0801-165	8.00	165.00	152.00	5.00
626105-0825-166	8.00	166.00	153.00	6.00
626105-0825-167	8.00	167.00	154.00	6.00
626105-0825-168	8.00	168.00	155.00	6.00
626105-0825-169	8.00	169.00	156.00	6.00
626105-0825-170	8.00	170.00	157.00	6.00
626105-0825-171	8.00	171.00	158.00	6.00
626105-0825-172	8.00	172.00	159.00	6.00
626105-0825-173	8.00	173.00	160.00	6.00
626105-0825-174	8.00	174.00	161.00	6.00
626105-0825-175	8.00	175.00	162.00	6.00
626115-0802-175	8.00	175.00	155.00	6.00
626105-0825-176	8.00	176.00	163.00	6.00
626105-0825-177	8.00	177.00	164.00	6.00
626105-0825-178	8.00	178.00	165.00	6.00
626105-0825-179	8.00	179.00	166.00	6.00
626105-0825-180	8.00	180.00	167.00	6.00
626105-0825-181	8.00	181.00	168.00	6.00
626105-0825-182	8.00	182.00	169.00	6.00
626105-0825-183	8.00	183.00	170.00	6.00
626105-0825-184	8.00	184.00	171.00	6.00
626105-0825-185	8.00	185.00	172.00	6.00
626105-0825-186	8.00	186.00	173.00	6.00
626105-0825-187	8.00	187.00	174.00	6.00
626105-0825-188	8.00	188.00	175.00	6.00



Article-No.	DK	L	ML	DS
626105-0825-189	8.00	189.00	176.00	6.00
626115-0803-200	8.00	200.00	187.00	6.00
626115-0806-200	8.00	200.00	190.00	4.00
626115-0800-225	8.00	225.00	210.00	6.00
626115-0801-240	8.00	240.00	228.00	6.00
626115-0800-250	8.00	250.00	230.00	6.00
626105-1025-035	10.00	35.00	22.00	6.00
626105-1025-036	10.00	36.00	23.00	6.00
626105-1025-037	10.00	37.00	24.00	6.00
626105-1025-038	10.00	38.00	25.00	6.00
626105-1025-039	10.00	39.00	26.00	6.00
626105-1025-040	10.00	40.00	27.00	6.00
626105-1025-041	10.00	41.00	28.00	6.00
626105-1025-042	10.00	42.00	29.00	6.00
626105-1025-043	10.00	43.00	30.00	6.00
626105-1025-044	10.00	44.00	31.00	6.00
626105-1025-045	10.00	45.00	32.00	6.00
626105-1025-046	10.00	46.00	33.00	6.00
626105-1025-047	10.00	47.00	34.00	6.00
626105-1025-048	10.00	48.00	35.00	6.00
626105-1025-049	10.00	49.00	36.00	6.00
626105-1025-050	10.00	50.00	37.00	6.00
626105-1025-051	10.00	51.00	38.00	6.00
626105-1025-052	10.00	52.00	39.00	6.00
626105-1025-053	10.00	53.00	40.00	6.00
626105-1025-054	10.00	54.00	41.00	6.00
626105-1025-055	10.00	55.00	42.00	6.00
626105-1025-056	10.00	56.00	43.00	6.00
626105-1025-057	10.00	57.00	44.00	6.00
626105-1025-058	10.00	58.00	45.00	6.00
626105-1025-059	10.00	59.00	46.00	6.00
626105-1025-060	10.00	60.00	47.00	6.00
626105-1025-061	10.00	61.00	48.00	6.00
626105-1025-062	10.00	62.00	49.00	6.00
626105-1025-063	10.00	63.00	50.00	6.00
626105-1025-064	10.00	64.00	51.00	6.00
626105-1025-065	10.00	65.00	52.00	6.00
626105-1025-066	10.00	66.00	53.00	6.00
626105-1025-067	10.00	67.00	54.00	6.00
626105-1025-068	10.00	68.00	55.00	6.00
626105-1025-069	10.00	69.00	56.00	6.00
626105-1025-070	10.00	70.00	57.00	6.00
626105-1025-071	10.00	71.00	58.00	6.00
626105-1025-072	10.00	72.00	59.00	6.00
626105-1025-073	10.00	73.00	60.00	6.00
626105-1025-074	10.00	74.00	61.00	6.00
626105-1025-075	10.00	75.00	62.00	6.00
626105-1025-076	10.00	76.00	63.00	6.00
626105-1025-077	10.00	77.00	64.00	6.00
626105-1025-078	10.00	78.00	65.00	6.00
626105-1025-079	10.00	79.00	66.00	6.00



Article-No.	DK	L	ML	DS
626105-1025-080	10.00	80.00	67.00	6.00
626105-1025-081	10.00	81.00	68.00	6.00
626105-1025-082	10.00	82.00	69.00	6.00
626105-1025-083	10.00	83.00	70.00	6.00
626105-1025-084	10.00	84.00	71.00	6.00
626105-1025-085	10.00	85.00	72.00	6.00
626105-1025-086	10.00	86.00	73.00	6.00
626105-1025-087	10.00	87.00	74.00	6.00
626105-1025-088	10.00	88.00	75.00	6.00
626105-1025-089	10.00	89.00	76.00	6.00
626105-1025-090	10.00	90.00	77.00	6.00
626105-1025-091	10.00	91.00	78.00	6.00
626105-1025-092	10.00	92.00	79.00	6.00
626105-1025-093	10.00	93.00	80.00	6.00
626105-1025-094	10.00	94.00	81.00	6.00
626105-1025-095	10.00	95.00	82.00	6.00
626105-1025-096	10.00	96.00	83.00	6.00
626105-1025-097	10.00	97.00	84.00	6.00
626105-1025-098	10.00	98.00	85.00	6.00
626105-1025-099	10.00	99.00	86.00	6.00
626105-1025-100	10.00	100.00	87.00	6.00
626105-1025-101	10.00	101.00	88.00	6.00
626105-1025-102	10.00	102.00	89.00	6.00
626105-1025-103	10.00	103.00	90.00	6.00
626105-1025-104	10.00	104.00	91.00	6.00
626105-1025-105	10.00	105.00	92.00	6.00
626105-1025-106	10.00	106.00	93.00	6.00
626105-1025-107	10.00	107.00	94.00	6.00
626105-1025-108	10.00	108.00	95.00	6.00
626105-1025-109	10.00	109.00	96.00	6.00
626105-1025-110	10.00	110.00	97.00	6.00
626105-1025-111	10.00	111.00	98.00	6.00
626105-1025-112	10.00	112.00	99.00	6.00
626105-1025-113	10.00	113.00	100.00	6.00
626105-1025-114	10.00	114.00	101.00	6.00
626105-1025-115	10.00	115.00	102.00	6.00
626105-1025-116	10.00	116.00	103.00	6.00
626105-1025-117	10.00	117.00	104.00	6.00
626105-1025-118	10.00	118.00	105.00	6.00
626105-1025-119	10.00	119.00	106.00	6.00
626105-1025-120	10.00	120.00	107.00	6.00
626105-1025-121	10.00	121.00	108.00	6.00
626105-1025-122	10.00	122.00	109.00	6.00
626105-1025-123	10.00	123.00	110.00	6.00
626105-1025-124	10.00	124.00	111.00	6.00
626115-1000-125	10.00	125.00	115.00	6.00
626105-1025-125	10.00	125.00	112.00	6.00
626105-1025-126	10.00	126.00	113.00	6.00
626105-1025-127	10.00	127.00	114.00	6.00
626105-1025-128	10.00	128.00	115.00	6.00
626105-1025-129	10.00	129.00	116.00	6.00
626105-1025-130	10.00	130.00	117.00	6.00
626105-1025-131	10.00	131.00	118.00	6.00
626105-1025-132	10.00	132.00	119.00	6.00



Article-No.	DK	L	ML	DS
626105-1025-133	10.00	133.00	120.00	6.00
626105-1025-134	10.00	134.00	121.00	6.00
626105-1025-135	10.00	135.00	122.00	6.00
626105-1025-136	10.00	136.00	123.00	6.00
626105-1025-137	10.00	137.00	124.00	6.00
626105-1025-138	10.00	138.00	125.00	6.00
626105-1025-139	10.00	139.00	126.00	6.00
626105-1025-140	10.00	140.00	127.00	6.00
626105-1025-141	10.00	141.00	128.00	6.00
626105-1025-142	10.00	142.00	129.00	6.00
626105-1025-143	10.00	143.00	130.00	6.00
626105-1025-144	10.00	144.00	131.00	6.00
626105-1025-145	10.00	145.00	132.00	6.00
626105-1025-146	10.00	146.00	133.00	6.00
626105-1025-147	10.00	147.00	134.00	6.00
626105-1025-148	10.00	148.00	135.00	6.00
626105-1025-149	10.00	149.00	136.00	6.00
626115-1000-150	10.00	150.00	140.00	6.00
626105-1025-150	10.00	150.00	137.00	6.00
626105-1025-151	10.00	151.00	138.00	6.00
626105-1025-152	10.00	152.00	139.00	6.00
626105-1025-153	10.00	153.00	140.00	6.00
626105-1025-154	10.00	154.00	141.00	6.00
626105-1025-155	10.00	155.00	142.00	6.00
626105-1025-156	10.00	156.00	143.00	6.00
626105-1025-157	10.00	157.00	144.00	6.00
626105-1025-158	10.00	158.00	145.00	6.00
626105-1025-159	10.00	159.00	146.00	6.00
626105-1025-160	10.00	160.00	147.00	6.00
626105-1025-161	10.00	161.00	148.00	6.00
626105-1025-162	10.00	162.00	149.00	6.00
626105-1025-163	10.00	163.00	150.00	6.00
626105-1025-164	10.00	164.00	151.00	6.00
626115-1000-165	10.00	165.00	150.00	6.00
626105-1025-165	10.00	165.00	152.00	6.00
626105-1025-166	10.00	166.00	153.00	6.00
626105-1025-167	10.00	167.00	154.00	6.00
626105-1025-168	10.00	168.00	155.00	6.00
626105-1025-169	10.00	169.00	156.00	6.00
626105-1025-170	10.00	170.00	157.00	6.00
626105-1025-171	10.00	171.00	158.00	6.00
626105-1025-172	10.00	172.00	159.00	6.00
626105-1025-173	10.00	173.00	160.00	6.00
626105-1025-174	10.00	174.00	161.00	6.00
626105-1025-175	10.00	175.00	162.00	6.00
626105-1025-176	10.00	176.00	163.00	6.00
626105-1025-177	10.00	177.00	164.00	6.00
626105-1025-178	10.00	178.00	165.00	6.00
626105-1025-179	10.00	179.00	166.00	6.00
626105-1025-180	10.00	180.00	167.00	6.00
626105-1025-181	10.00	181.00	168.00	6.00





Article-No.	DK	L	ML	DS
626105-1025-182	10.00	182.00	169.00	6.00
626105-1025-183	10.00	183.00	170.00	6.00
626105-1025-184	10.00	184.00	171.00	6.00
626105-1025-185	10.00	185.00	172.00	6.00
626105-1025-186	10.00	186.00	173.00	6.00
626105-1025-187	10.00	187.00	174.00	6.00
626105-1025-188	10.00	188.00	175.00	6.00
626105-1025-189	10.00	189.00	176.00	6.00
626115-1000-200	10.00	200.00	187.00	6.00
626105-1225-035	12.00	35.00	22.00	6.00
626105-1225-036	12.00	36.00	23.00	6.00
626105-1225-037	12.00	37.00	24.00	6.00
626105-1225-038	12.00	38.00	25.00	6.00
626105-1225-039	12.00	39.00	26.00	6.00
626115-1201-040	12.00	40.00	27.00	5.00
626105-1225-040	12.00	40.00	27.00	6.00
626105-1225-041	12.00	41.00	28.00	6.00
626105-1225-042	12.00	42.00	29.00	6.00
626105-1225-043	12.00	43.00	30.00	6.00
626105-1225-044	12.00	44.00	31.00	6.00
626105-1225-045	12.00	45.00	32.00	6.00
626105-1225-046	12.00	46.00	33.00	6.00
626105-1225-047	12.00	47.00	34.00	6.00
626105-1225-048	12.00	48.00	35.00	6.00
626105-1225-049	12.00	49.00	36.00	6.00
626105-1225-050	12.00	50.00	37.00	6.00
626105-1225-051	12.00	51.00	38.00	6.00
626105-1225-052	12.00	52.00	39.00	6.00
626105-1225-053	12.00	53.00	40.00	6.00
626105-1225-054	12.00	54.00	41.00	6.00
626105-1225-055	12.00	55.00	42.00	6.00
626105-1225-056	12.00	56.00	43.00	6.00
626105-1225-057	12.00	57.00	44.00	6.00
626105-1225-058	12.00	58.00	45.00	6.00
626105-1225-059	12.00	59.00	46.00	6.00
626105-1225-060	12.00	60.00	47.00	6.00
626105-1225-061	12.00	61.00	48.00	6.00
626105-1225-062	12.00	62.00	49.00	6.00
626105-1225-063	12.00	63.00	50.00	6.00
626105-1225-064	12.00	64.00	51.00	6.00
626105-1225-065	12.00	65.00	52.00	6.00
626105-1225-066	12.00	66.00	53.00	6.00
626105-1225-067	12.00	67.00	54.00	6.00
626105-1225-068	12.00	68.00	55.00	6.00
626105-1225-069	12.00	69.00	56.00	6.00
626105-1225-070	12.00	70.00	57.00	6.00
626105-1225-071	12.00	71.00	58.00	6.00
626105-1225-072	12.00	72.00	59.00	6.00
626105-1225-073	12.00	73.00	60.00	6.00
626105-1225-074	12.00	74.00	61.00	6.00
626105-1225-075	12.00	75.00	62.00	6.00
626105-1225-076	12.00	76.00	63.00	6.00
626105-1225-077	12.00	77.00	64.00	6.00
626105-1225-078	12.00	78.00	65.00	6.00



Article-No.	DK	L	ML	DS
626105-1225-079	12.00	79.00	66.00	6.00
626105-1225-080	12.00	80.00	67.00	6.00
626105-1225-081	12.00	81.00	68.00	6.00
626105-1225-082	12.00	82.00	69.00	6.00
626105-1225-083	12.00	83.00	70.00	6.00
626105-1225-084	12.00	84.00	71.00	6.00
626105-1225-085	12.00	85.00	72.00	6.00
626105-1225-086	12.00	86.00	73.00	6.00
626105-1225-087	12.00	87.00	74.00	6.00
626105-1225-088	12.00	88.00	75.00	6.00
626105-1225-089	12.00	89.00	76.00	6.00
626105-1225-090	12.00	90.00	77.00	6.00
626105-1225-091	12.00	91.00	78.00	6.00
626105-1225-092	12.00	92.00	79.00	6.00
626105-1225-093	12.00	93.00	80.00	6.00
626105-1225-094	12.00	94.00	81.00	6.00
626105-1225-095	12.00	95.00	82.00	6.00
626105-1225-096	12.00	96.00	83.00	6.00
626105-1225-097	12.00	97.00	84.00	6.00
626105-1225-098	12.00	98.00	85.00	6.00
626105-1225-099	12.00	99.00	86.00	6.00
626105-1225-100	12.00	100.00	87.00	6.00
626105-1225-101	12.00	101.00	88.00	6.00
626105-1225-102	12.00	102.00	89.00	6.00
626105-1225-103	12.00	103.00	90.00	6.00
626105-1225-104	12.00	104.00	91.00	6.00
626105-1225-105	12.00	105.00	92.00	6.00
626105-1225-106	12.00	106.00	93.00	6.00
626105-1225-107	12.00	107.00	94.00	6.00
626105-1225-108	12.00	108.00	95.00	6.00
626105-1225-109	12.00	109.00	96.00	6.00
626105-1225-110	12.00	110.00	97.00	6.00
626105-1225-111	12.00	111.00	98.00	6.00
626105-1225-112	12.00	112.00	99.00	6.00
626105-1225-113	12.00	113.00	100.00	6.00
626105-1225-114	12.00	114.00	101.00	6.00
626105-1225-115	12.00	115.00	102.00	6.00
626105-1225-116	12.00	116.00	103.00	6.00
626105-1225-117	12.00	117.00	104.00	6.00
626105-1225-118	12.00	118.00	105.00	6.00
626105-1225-119	12.00	119.00	106.00	6.00
626105-1225-120	12.00	120.00	107.00	6.00
626105-1225-121	12.00	121.00	108.00	6.00
626105-1225-122	12.00	122.00	109.00	6.00
626105-1225-123	12.00	123.00	110.00	6.00
626105-1225-124	12.00	124.00	111.00	6.00
626105-1225-125	12.00	125.00	112.00	6.00
626105-1225-126	12.00	126.00	113.00	6.00
626105-1225-127	12.00	127.00	114.00	6.00
626105-1225-128	12.00	128.00	115.00	6.00
626105-1225-129	12.00	129.00	116.00	6.00



Article-No.	DK	L	ML	DS
626105-1225-130	12.00	130.00	117.00	6.00
626105-1225-131	12.00	131.00	118.00	6.00
626105-1225-132	12.00	132.00	119.00	6.00
626105-1225-133	12.00	133.00	120.00	6.00
626105-1225-134	12.00	134.00	121.00	6.00
626105-1225-135	12.00	135.00	122.00	6.00
626105-1225-136	12.00	136.00	123.00	6.00
626105-1225-137	12.00	137.00	124.00	6.00
626105-1225-138	12.00	138.00	125.00	6.00
626105-1225-139	12.00	139.00	126.00	6.00
626105-1225-140	12.00	140.00	127.00	6.00
626105-1225-141	12.00	141.00	128.00	6.00
626105-1225-142	12.00	142.00	129.00	6.00
626105-1225-143	12.00	143.00	130.00	6.00
626105-1225-144	12.00	144.00	131.00	6.00
626105-1225-145	12.00	145.00	132.00	6.00
626105-1225-146	12.00	146.00	133.00	6.00
626105-1225-147	12.00	147.00	134.00	6.00
626105-1225-148	12.00	148.00	135.00	6.00
626105-1225-149	12.00	149.00	136.00	6.00
626105-1225-150	12.00	150.00	137.00	6.00
626105-1225-151	12.00	151.00	138.00	6.00
626105-1225-152	12.00	152.00	139.00	6.00
626105-1225-153	12.00	153.00	140.00	6.00
626105-1225-154	12.00	154.00	141.00	6.00
626105-1225-155	12.00	155.00	142.00	6.00
626105-1225-156	12.00	156.00	143.00	6.00
626105-1225-157	12.00	157.00	144.00	6.00
626105-1225-158	12.00	158.00	145.00	6.00
626105-1225-159	12.00	159.00	146.00	6.00
626105-1225-160	12.00	160.00	147.00	6.00
626115-1201-160	12.00	160.00	150.00	4.50
626105-1225-161	12.00	161.00	148.00	6.00
626105-1225-162	12.00	162.00	149.00	6.00
626105-1225-163	12.00	163.00	150.00	6.00
626105-1225-164	12.00	164.00	151.00	6.00
626105-1225-165	12.00	165.00	152.00	6.00
626105-1225-166	12.00	166.00	153.00	6.00
626105-1225-167	12.00	167.00	154.00	6.00
626105-1225-168	12.00	168.00	155.00	6.00
626105-1225-169	12.00	169.00	156.00	6.00
626105-1225-170	12.00	170.00	157.00	6.00
626105-1225-171	12.00	171.00	158.00	6.00
626105-1225-172	12.00	172.00	159.00	6.00
626105-1225-173	12.00	173.00	160.00	6.00
626105-1225-174	12.00	174.00	161.00	6.00
626105-1225-175	12.00	175.00	162.00	6.00
626105-1225-176	12.00	176.00	163.00	6.00
626105-1225-177	12.00	177.00	164.00	6.00
626105-1225-178	12.00	178.00	165.00	6.00
626105-1225-179	12.00	179.00	166.00	6.00
626105-1225-180	12.00	180.00	167.00	6.00
626105-1225-181	12.00	181.00	168.00	6.00
626105-1225-182	12.00	182.00	169.00	6.00



Article-No.	DK	L	ML	DS
626105-1225-183	12.00	183.00	170.00	6.00
626105-1225-184	12.00	184.00	171.00	6.00
626105-1225-185	12.00	185.00	172.00	6.00
626105-1225-186	12.00	186.00	173.00	6.00
626105-1225-187	12.00	187.00	174.00	6.00
626105-1225-188	12.00	188.00	175.00	6.00
626105-1225-189	12.00	189.00	176.00	6.00
626115-1201-235	12.00	235.00	215.00	10.00
626115-1401-065	14.00	65.00	52.00	6.00
626115-1400-118	14.00	118.00	105.00	6.00
626115-1500-035	15.00	35.00	25.00	6.00
626115-1501-095	15.00	95.00	70.00	5.00
626115-1500-113	15.00	113.00	100.00	6.00
626115-1500-118	15.00	118.00	105.00	6.00
626115-1502-160	15.00	160.00	145.00	4.00
626115-1500-213	15.00	213.00	200.00	6.00
626115-1590-032	15.88	31.50	21.50	5.00

### M5, Styli straight, silicon nitride sphere, carbon fibre shaft

Standard Styli suitable for all common measuring tasks. M5 thread for VAST active scanning sensors.

Connection Type: M5  
 Shaft Material: Carbon Fiber  
 Stylus Tip Geometry: Sphere  
 Stylus Tip Material: Si. Nitride  
 Ø Body (DG): 11

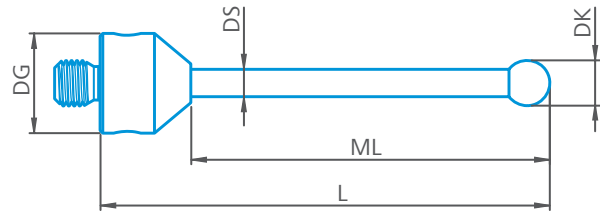

Article-No.	DK	L	ML	DS
626105-0301-025	3.00	25.00	15.00	2.00
626105-0301-033	3.00	33.00	23.00	2.00
626105-0301-050	3.00	50.00	40.00	2.00
626105-0301-058	3.00	58.00	48.00	2.00
626105-0301-064	3.00	64.00	54.00	2.00
626105-0351-075	3.50	75.00	65.00	2.00
626105-0401-033	4.00	33.00	23.00	2.00
626105-0401-040	4.00	40.00	30.00	2.00
626105-0401-064	4.00	64.00	54.00	2.00
626105-0401-075	4.00	75.00	65.00	2.00
626105-0511-050	5.00	50.00	40.00	3.50
626105-0511-075	5.00	75.00	65.00	3.50
626105-0511-080	5.00	80.00	70.00	3.50
626105-0511-100	5.00	100.00	90.00	3.50
626105-0511-105	5.00	105.00	95.00	3.50
626105-0511-120	5.00	120.00	110.00	3.50
626105-0511-135	5.00	135.00	125.00	3.50
626105-0511-150	5.00	150.00	140.00	3.50
626105-0511-180	5.00	180.00	160.00	3.50



Article-No.	DK	L	ML	DS
626105-0511-200	5.00	200.00	180.00	3.50
626115-0602-105	6.00	105.00	92.00	5.00
626105-0611-135	6.00	135.00	125.00	3.50
626115-0700-250	7.00	250.00	230.00	5.00
626105-0721-275	7.00	275.00	250.00	6.00
626105-0821-063	8.00	63.00	50.00	6.00
626105-0821-075	8.00	75.00	62.00	6.00
626105-0821-100	8.00	100.00	87.00	6.00
626105-0821-114	8.00	114.00	101.00	6.00
626105-0821-150	8.00	150.00	137.00	6.00
626105-0821-175	8.00	175.00	162.00	6.00
626105-0821-200	8.00	200.00	187.00	6.00
626105-0800-253	8.00	253.00	228.00	6.00
626105-0821-265	8.00	265.00	240.00	6.00
626105-0821-300	8.00	300.00	275.00	6.00
626105-0821-400	8.00	400.00	375.00	6.00
626105-1021-025	10.00	25.00	12.00	6.00
626105-1021-035	10.00	35.00	22.00	6.00
626105-1021-050	10.00	50.00	37.00	6.00
626105-1021-065	10.00	65.00	52.00	6.00
626115-1002-090	10.00	90.00	80.00	4.00
626105-1021-118	10.00	118.00	105.00	6.00
626105-1021-150	10.00	150.00	137.00	6.00
626105-1021-200	10.00	200.00	187.00	6.00
626115-1000-260	10.00	260.00	247.00	5.00
626105-1021-315	10.00	315.00	290.00	6.00
626105-1021-350	10.00	350.00	325.00	6.00
626105-1021-500	10.00	500.00	475.00	6.00

## M5, Styli stepped, ruby sphere, tungsten carbide shaft

Standard Styli suitable for all common measuring tasks. M5 thread for VAST active scanning sensors.

Connection Type: M5  
 Shaft Material: Tung. Carb.  
 Stylus Tip Geometry: Sphere  
 Stylus Tip Material: Ruby  
 Ø Body (DG): 11

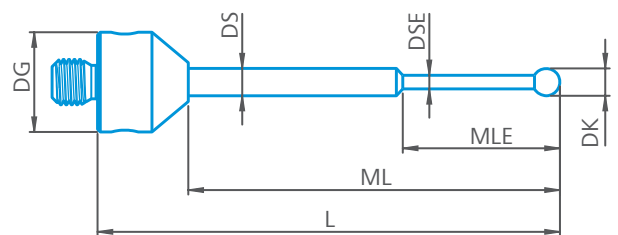

Article-No.	DK	L	ML	DS	MLE	DSE
626115-0020-018	0.20	17.50	7.50	2.00	2.50	0.10
626115-0021-025	0.20	25.00	14.00	1.00	1.30	0.10
626105-5244-013	0.30	13.00	3.00	1.00	2.30	0.20
626105-5244-014	0.30	14.00	4.00	1.00	2.30	0.20
626115-0030-015	0.30	15.00	5.00	1.00	2.30	0.20
626105-5244-016	0.30	16.00	6.00	1.00	2.30	0.20
626105-5244-017	0.30	17.00	7.00	1.00	2.30	0.20
626105-5244-018	0.30	18.00	8.00	1.00	2.30	0.20
626105-5244-019	0.30	19.00	9.00	1.00	2.30	0.20
626105-5244-020	0.30	20.00	10.00	1.00	2.30	0.20
626105-5244-021	0.30	21.00	11.00	1.00	2.30	0.20



Article-No.	DK	L	ML	DS	MLE	DSE
626115-0030-022	0.30	21.80	12.80	1.00	2.30	0.20
626115-0034-022	0.30	21.80	11.80	1.00	3.30	0.20
626105-5244-022	0.30	22.00	12.00	1.00	2.30	0.20
626115-0030-026	0.30	26.00	16.00	0.80	2.30	0.20
626115-0030-033	0.30	33.00	23.00	1.00	5.00	0.25
626115-0030-035	0.30	35.00	25.00	1.00	2.30	0.20
626105-5444-013	0.50	13.00	3.00	1.00	2.50	0.30
626105-5444-014	0.50	14.00	4.00	1.00	2.50	0.30
626115-0050-015	0.50	15.00	5.00	1.50	2.50	0.30
626105-5444-015	0.50	15.00	5.00	1.00	2.50	0.30
626105-5444-016	0.50	16.00	6.00	1.00	2.50	0.30
626105-5444-017	0.50	17.00	7.00	1.00	2.50	0.30
626105-5444-018	0.50	18.00	8.00	1.00	2.50	0.30
626105-5444-019	0.50	19.00	9.00	1.00	2.50	0.30
626105-5444-020	0.50	20.00	10.00	1.00	2.50	0.30
626105-5444-021	0.50	21.00	11.00	1.00	2.50	0.30
626115-0050-022	0.50	22.00	13.00	1.00	2.50	0.30
626105-5444-022	0.50	22.00	12.00	1.00	2.50	0.30
626115-0052-025	0.50	25.00	15.00	1.00	7.00	0.30
626105-0050-029	0.50	29.00	19.00	1.00	2.50	0.30
626115-0051-030	0.50	30.00	20.00	1.00	2.50	0.30
626115-0051-032	0.50	32.00	22.00	1.00	5.00	0.30
626115-0052-032	0.50	32.00	22.00	1.00	0.60	0.30
626115-0052-035	0.50	35.00	25.00	1.50	3.00	0.30
626115-0051-035	0.50	35.00	25.00	3.00	2.60	0.30
626115-0051-040	0.50	40.00	30.00	1.00	2.50	0.30
626115-0051-050	0.50	50.00	40.00	1.30	4.00	0.35
626115-0050-050	0.50	50.00	40.00	2.00	4.00	0.35
626115-0050-055	0.50	55.00	45.00	2.00	2.50	0.30
626115-0050-060	0.50	60.00	50.00	1.00	5.00	0.35
626105-5544-014	0.60	14.00	4.00	1.00	4.00	0.40
626105-5544-015	0.60	15.00	5.00	1.00	4.60	0.40
626105-5544-016	0.60	16.00	6.00	1.00	4.60	0.40
626105-5544-017	0.60	17.00	7.00	1.00	4.60	0.40
626105-5544-018	0.60	18.00	8.00	1.00	4.60	0.40
626105-5544-019	0.60	19.00	9.00	1.00	4.60	0.40
626105-5544-020	0.60	20.00	10.00	1.00	4.60	0.40
626105-5544-021	0.60	21.00	11.00	1.00	4.60	0.40
626115-0061-022	0.60	22.00	12.00	1.00	2.50	0.40
626105-5544-022	0.60	22.00	12.00	1.00	4.60	0.40
626115-0060-022	0.60	22.10	13.10	1.00	4.60	0.40
626115-0061-021	0.60	22.10	13.10	1.00	6.00	0.40
626115-0062-022	0.60	22.10	12.10	1.00	4.60	0.40
626115-0060-025	0.60	25.00	14.50	1.00	4.00	0.40
626115-0062-025	0.60	25.00	15.00	1.50	8.00	0.40
626115-0060-035	0.60	35.00	25.00	1.50	5.00	0.40
626115-5000-376	0.60	40.00	30.00	2.00	5.00	0.40
626115-0060-060	0.60	60.00	35.00	2.00	7.00	0.43
626115-0063-022	0.62	22.10	13.10	1.00	4.60	0.40
626115-0070-022	0.70	22.00	12.00	1.00	4.60	0.40
626115-0070-031	0.70	31.00	21.00	2.00	7.00	0.60



Article-No.	DK	L	ML	DS	MLE	DSE
626105-5644-015	0.80	15.00	5.00	1.00	4.80	0.60
626105-5644-016	0.80	16.00	6.00	1.00	4.80	0.60
626105-5644-017	0.80	17.00	7.00	1.00	4.80	0.60
626105-5644-018	0.80	18.00	8.00	1.00	4.80	0.60
626105-5644-019	0.80	19.00	9.00	1.00	4.80	0.60
626105-5644-020	0.80	20.00	10.00	1.00	4.80	0.60
626105-5644-021	0.80	21.00	11.00	1.00	4.80	0.60
626105-5644-022	0.80	22.00	12.00	1.00	4.80	0.60
626115-0080-022	0.80	22.30	13.30	1.00	4.80	0.60
626105-5644-023	0.80	23.00	13.00	1.00	4.80	0.60
626105-5644-024	0.80	24.00	14.00	1.00	4.80	0.60
626115-0080-025	0.80	25.00	14.00	1.00	4.60	0.50
626105-5644-025	0.80	25.00	15.00	1.00	4.80	0.60
626115-0084-025	0.80	25.00	15.00	2.00	8.00	0.60
626115-0081-025	0.80	25.00	15.00	1.00	6.00	0.35
626105-5644-026	0.80	26.00	16.00	1.00	4.80	0.60
626105-5644-027	0.80	27.00	17.00	1.00	4.80	0.60
626105-5644-028	0.80	28.00	18.00	1.00	4.80	0.60
626105-5644-029	0.80	29.00	19.00	1.00	4.80	0.60
626105-5644-030	0.80	30.00	20.00	1.00	4.80	0.60
626105-5644-031	0.80	31.00	21.00	1.00	4.80	0.60
626105-5644-032	0.80	32.00	22.00	1.00	4.80	0.60
626115-0080-033	0.80	33.00	23.00	1.00	5.00	0.50
626105-5644-033	0.80	33.00	23.00	1.00	4.80	0.60
626105-5644-034	0.80	34.00	24.00	1.00	4.80	0.60
626115-0080-035	0.80	35.00	25.00	3.00	7.00	0.50
626115-0083-035	0.80	35.00	24.00	1.00	4.60	0.50
626105-5644-035	0.80	35.00	25.00	1.00	4.80	0.60
000000-0577-239	0.80	35.00	25.00	1.00	10.00	0.60
626115-0082-035	0.80	35.00	25.00	1.00	15.00	0.60
626115-0080-036	0.80	35.50	24.00	1.00	5.00	0.50
626115-0081-036	0.80	36.00	26.00	1.00	5.00	0.50
626105-5644-036	0.80	36.00	26.00	1.00	4.80	0.60
626105-5644-037	0.80	37.00	27.00	1.00	4.80	0.60
626115-0080-040	0.80	40.00	30.00	1.00	4.80	0.60
626115-0083-040	0.80	40.00	30.00	4.00	20.00	0.60
626115-0080-045	0.80	45.00	35.00	1.00	8.00	0.60
626115-0090-030	0.90	30.00	20.00	1.00	4.80	0.60
626105-0044-015	1.00	15.00	5.00	1.00	5.00	0.80
626105-0044-016	1.00	16.00	6.00	1.00	5.00	0.80
626105-0044-017	1.00	17.00	7.00	1.00	5.00	0.80
626105-0044-018	1.00	18.00	8.00	1.00	5.00	0.80
626105-0044-019	1.00	19.00	9.00	1.00	5.00	0.80
626105-0044-020	1.00	20.00	10.00	1.00	5.00	0.80
626115-0100-020	1.00	20.00	9.00	1.00	5.00	0.70
626105-0044-021	1.00	21.00	11.00	1.00	5.00	0.80
626115-0105-022	1.00	22.00	12.00	1.00	5.00	0.80
626115-0100-022	1.00	22.50	12.50	1.00	5.00	0.80
626105-0044-023	1.00	23.00	13.00	1.00	5.00	0.80
626105-0044-024	1.00	24.00	14.00	1.00	5.00	0.80
626105-0044-025	1.00	25.00	15.00	1.00	5.00	0.80
626115-0100-025	1.00	25.00	15.00	1.00	8.00	0.70
626105-0044-026	1.00	26.00	16.00	1.00	5.00	0.80
626105-0044-027	1.00	27.00	17.00	1.00	5.00	0.80



Article-No.	DK	L	ML	DS	MLE	DSE
626105-0044-028	1.00	28.00	18.00	1.00	5.00	0.80
626105-0044-029	1.00	29.00	19.00	1.00	5.00	0.80
626115-0101-030	1.00	30.00	20.00	1.50	5.00	0.70
626115-0106-030	1.00	30.00	20.00	1.00	5.00	0.80
626115-0102-030	1.00	30.00	20.00	2.00	10.00	0.80
626105-0044-031	1.00	31.00	21.00	1.00	5.00	0.80
626115-0101-032	1.00	32.00	22.00	1.00	5.00	0.80
626115-0107-032	1.00	32.00	22.00	2.00	12.00	0.80
626105-0044-033	1.00	33.00	23.00	1.00	5.00	0.80
626115-0100-034	1.00	33.50	23.50	1.00	7.00	0.80
626105-0044-034	1.00	34.00	24.00	1.00	5.00	0.80
626105-0044-035	1.00	35.00	25.00	1.00	5.00	0.80
626105-0044-036	1.00	36.00	26.00	1.00	5.00	0.80
626115-0100-036	1.00	36.00	26.00	2.00	6.00	0.80
626105-0044-037	1.00	37.00	27.00	1.00	5.00	0.80
626105-0044-038	1.00	38.00	28.00	1.00	5.00	0.80
626105-0044-039	1.00	39.00	29.00	1.00	5.00	0.80
626105-0044-040	1.00	40.00	30.00	1.00	5.00	0.80
626115-0100-040	1.00	40.00	30.00	1.00	15.00	0.80
626105-0044-041	1.00	41.00	31.00	1.00	5.00	0.80
626105-0044-042	1.00	42.00	32.00	1.00	5.00	0.80
626115-0100-042	1.00	42.00	32.00	3.00	12.00	0.80
626115-0101-045	1.00	45.00	35.00	2.00	17.00	0.74
626115-0102-046	1.00	46.00	35.00	1.50	20.00	0.70
626115-0100-046	1.00	46.00	36.00	1.50	15.00	0.70
626115-0101-046	1.00	46.00	35.00	1.50	10.00	0.70
626115-0102-050	1.00	50.00	40.00	3.00	15.00	0.75
626115-0100-050	1.00	50.00	40.00	2.00	15.00	0.80
626115-0103-055	1.00	55.00	40.00	4.00	30.00	0.70
612030-9327-000	1.00	60.00	45.00	1.00	5.00	0.70
626115-0104-060	1.00	60.00	50.00	1.00	10.00	0.70
626115-0101-065	1.00	65.00	55.00	4.00	13.00	0.80
626115-0103-065	1.00	65.00	55.00	3.00	22.00	0.80
626115-0100-075	1.00	75.00	65.00	1.50	5.50	0.70
626115-0110-032	1.10	32.00	22.00	1.00	5.00	0.80
626115-0121-022	1.20	22.00	12.00	1.00	5.50	0.60
626115-0130-170	1.30	170.00	160.00	3.00	50.00	1.00
602030-8062-000	1.35	32.00	22.00	4.00	12.00	1.00
602030-8063-000	1.35	44.00	34.00	4.00	19.00	1.00
626115-0135-044	1.35	44.00	34.00	4.00	22.00	1.00
626115-0141-046	1.35	46.00	36.00	2.00	10.00	1.00
626115-0140-050	1.35	50.00	40.00	4.00	25.00	1.00
626115-0140-054	1.35	54.00	44.00	2.00	17.00	1.00
626115-0141-065	1.35	65.00	55.00	4.00	13.00	0.90
626115-0150-030	1.50	30.00	19.00	1.50	8.00	1.00
626115-0154-030	1.50	30.00	20.00	4.00	5.00	1.00
602030-8064-000	1.50	32.00	22.00	4.00	12.00	1.00
602030-8065-000	1.50	44.00	34.00	4.00	19.00	1.00
626115-0155-044	1.50	44.00	34.00	4.00	20.00	1.00
626115-0151-045	1.50	45.00	34.00	3.00	20.00	1.00
626115-0152-050	1.50	50.00	40.00	4.00	30.00	1.00





Article-No.	DK	L	ML	DS	MLE	DSE
626115-0152-055	1.50	55.00	45.00	2.00	27.00	1.00
626115-0154-055	1.50	55.00	45.00	4.00	29.00	1.00
626115-0150-055	1.50	55.00	45.00	4.00	30.00	1.00
626115-0151-058	1.50	58.00	48.00	4.00	33.00	1.00
626115-0150-061	1.50	61.00	48.00	1.50	33.00	1.00
626115-0151-075	1.50	75.00	65.00	2.00	20.00	1.00
626115-0150-095	1.50	95.00	80.00	4.00	25.00	1.00
626115-0150-100	1.50	100.00	90.00	3.50	52.00	1.00
626115-0150-104	1.50	104.00	95.00	1.50	40.00	1.00
626115-0151-110	1.50	110.00	100.00	3.00	35.00	1.00
626115-0150-145	1.50	145.00	135.00	3.00	5.00	1.00
626115-0161-050	1.60	50.00	40.00	4.00	10.00	1.00
626115-0183-060	1.75	60.00	45.00	4.00	10.00	1.30
626115-0190-170	1.90	170.00	160.00	3.00	50.00	1.60
602030-8066-000	2.00	32.00	22.00	4.00	12.00	1.50
626115-0210-040	2.00	40.00	30.00	4.00	20.00	1.00
602030-8067-000	2.00	44.00	34.00	4.00	19.00	1.50
626115-0200-045	2.00	45.00	35.00	3.00	20.00	1.50
626115-0203-045	2.00	45.00	35.00	4.00	25.00	1.00
626115-0206-050	2.00	50.00	40.00	4.00	30.00	1.00
626115-0210-050	2.00	50.00	40.00	4.00	25.00	1.50
626115-0200-053	2.00	53.00	43.00	4.00	33.00	1.50
626115-0204-055	2.00	55.00	45.00	2.50	10.00	1.50
602030-8068-000	2.00	58.00	48.00	4.00	33.00	1.50
626115-0207-058	2.00	58.00	48.00	4.00	33.00	1.00
626115-0201-060	2.00	60.00	49.00	4.00	40.00	1.50
626115-0208-060	2.00	60.00	50.00	4.00	40.00	1.50
626115-0209-060	2.00	60.00	50.00	4.00	40.00	1.00
626115-0202-065	2.00	64.50	54.50	3.50	17.00	1.50
626115-5000-011	2.00	65.00	55.00	4.00	45.00	1.50
626115-0200-065	2.00	65.00	54.00	4.00	45.00	1.50
626115-0200-070	2.00	70.00	60.00	2.00	40.00	1.50
626115-0201-072	2.00	72.00	62.00	4.00	17.00	1.50
626115-0201-080	2.00	80.00	70.00	3.00	32.00	1.50
626115-0200-080	2.00	80.00	70.00	4.00	60.00	1.50
626115-0200-085	2.00	85.00	75.00	3.00	60.00	1.50
626115-0200-095	2.00	95.00	85.00	4.00	33.00	1.50
626115-0201-110	2.00	110.00	100.00	3.00	40.00	1.50
626115-0201-115	2.00	115.00	105.00	4.00	22.00	1.00
626115-0200-145	2.00	145.00	135.00	4.00	25.00	1.50
626115-0200-160	2.00	160.00	147.00	6.00	30.00	1.50
626115-0200-180	2.00	180.00	167.00	6.00	30.00	1.50
626115-0204-033	2.03	33.25	23.25	4.00	10.00	1.50
626115-0202-059	2.03	59.00	49.00	4.00	34.00	1.50
626115-0210-065	2.10	65.00	55.00	4.00	45.00	1.50
602030-8069-000	2.50	32.00	22.00	4.00	12.00	1.50
602030-8070-000	2.50	44.00	34.00	4.00	19.00	1.50
626115-0252-050	2.50	50.00	40.00	2.00	25.00	1.00
602030-8071-000	2.50	58.00	48.00	4.00	33.00	1.50
626115-0250-075	2.50	75.00	60.00	5.00	30.00	2.00
626115-0250-093	2.50	93.00	83.00	3.00	33.00	1.50
626115-0260-044	2.60	44.00	34.00	4.00	19.00	1.50
626115-0300-044	3.00	44.00	32.00	4.00	19.00	1.50
626115-0305-058	3.00	58.00	48.00	4.00	40.00	1.50



Article-No.	DK	L	ML	DS	MLE	DSE
626115-0301-065	3.00	65.00	55.00	6.00	45.00	2.00
626115-0301-068	3.00	68.00	58.00	4.00	45.00	1.00
626115-0302-068	3.00	68.00	58.00	4.00	45.00	2.00
626115-0301-070	3.00	70.00	57.00	4.00	40.00	2.00
626115-0301-080	3.00	80.00	70.00	4.00	60.00	2.00
626115-0301-090	3.00	90.00	80.00	3.00	50.00	2.00
626115-0300-092	3.00	92.00	79.00	7.00	50.00	2.00
626115-0302-095	3.00	95.00	80.00	4.00	60.00	2.00
626115-0303-100	3.00	100.00	90.00	4.00	60.00	2.00
626115-0304-100	3.00	100.00	90.00	4.00	65.00	2.00
626115-0300-105	3.00	105.00	94.00	4.00	40.00	2.00
626115-0303-105	3.00	105.00	95.00	4.00	50.00	2.00
626115-0300-110	3.00	110.00	100.00	4.00	45.00	2.00
626115-0305-110	3.00	110.00	100.00	4.00	60.00	2.00
626115-0303-112	3.00	112.00	99.00	5.00	71.00	2.00
626115-0302-115	3.00	115.00	99.00	3.00	24.00	2.00
626115-0301-115	3.00	115.00	100.00	5.00	50.00	2.00
626115-0304-120	3.00	120.00	110.00	2.50	10.00	2.00
626115-0306-120	3.00	120.00	110.00	2.50	25.00	2.00
626115-0300-130	3.00	130.00	120.00	3.50	30.00	2.00
626115-0300-145	3.00	145.00	130.00	4.00	15.00	2.00
626115-0300-180	3.00	180.00	167.00	6.00	50.00	2.20
626115-0402-032	4.00	32.00	22.00	4.00	16.00	1.00
626115-0402-092	4.00	92.00	82.00	3.00	16.00	2.00
626115-0403-135	4.00	135.00	125.00	4.00	77.00	2.00
626115-0400-135	4.00	135.00	123.00	4.00	77.00	3.00
626115-0400-174	4.00	174.00	160.00	6.00	100.00	3.00
626115-0502-100	5.00	100.00	90.00	3.50	63.00	2.50
626115-0500-104	5.00	104.00	90.00	5.00	20.00	3.50
626115-0500-134	5.00	134.00	120.00	6.00	50.00	3.00
626115-0501-240	5.00	240.00	225.00	5.00	50.00	3.50
626115-0603-060	6.00	60.00	47.00	3.00	25.00	2.00

### M5, Styli stepped, silicon nitride sphere, tungsten carbide shaft

Standard Styli suitable for all common measuring tasks. M5 thread for VAST active scanning sensors.

Connection Type: M5  
 Shaft Material: Tung. Carb.  
 Stylus Tip Geometry: Sphere  
 Stylus Tip Material: Si. Nitride  
 Ø Body (DG): 11

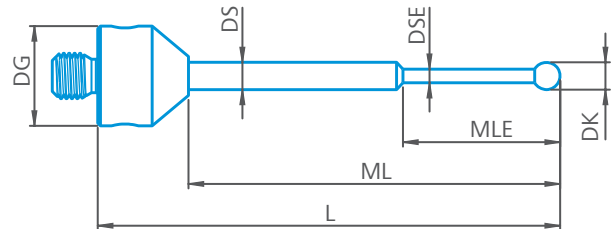

Article-No.	DK	L	ML	DS	MLE	DSE
626105-5245-013	0.30	13.00	3.00	1.00	2.30	0.20
626105-5245-014	0.30	14.00	4.00	1.00	2.30	0.20
626105-5245-015	0.30	15.00	5.00	1.00	2.30	0.20
626105-5245-016	0.30	16.00	6.00	1.00	2.30	0.20



Article-No.	DK	L	ML	DS	MLE	DSE
626105-5245-017	0.30	17.00	7.00	1.00	2.30	0.20
626105-5245-018	0.30	18.00	8.00	1.00	2.30	0.20
626105-5245-019	0.30	19.00	9.00	1.00	2.30	0.20
626105-5245-020	0.30	20.00	10.00	1.00	2.30	0.20
626105-5245-021	0.30	21.00	11.00	1.00	2.30	0.20
626105-5245-022	0.30	22.00	12.00	1.00	2.30	0.20
626115-0032-022	0.30	22.00	13.00	1.00	2.30	0.20
626105-5445-013	0.50	13.00	3.00	1.00	2.50	0.30
626105-5445-014	0.50	14.00	4.00	1.00	2.50	0.30
626105-5445-015	0.50	15.00	5.00	1.00	2.50	0.30
626105-5445-016	0.50	16.00	6.00	1.00	2.50	0.30
626105-5445-017	0.50	17.00	7.00	1.00	2.50	0.30
626105-5445-018	0.50	18.00	8.00	1.00	2.50	0.30
626105-5445-019	0.50	19.00	9.00	1.00	2.50	0.30
626105-5445-020	0.50	20.00	10.00	1.00	2.50	0.30
626115-0051-020	0.50	20.00	13.00	3.00	4.00	0.40
626105-5445-021	0.50	21.00	11.00	1.00	2.50	0.30
626105-5445-022	0.50	22.00	12.00	1.00	2.50	0.30
626115-0052-022	0.50	22.30	13.30	1.00	4.80	0.30
626105-5545-014	0.60	14.00	4.00	1.00	4.00	0.40
626105-5545-015	0.60	15.00	5.00	1.00	4.60	0.40
626105-5545-016	0.60	16.00	6.00	1.00	4.60	0.40
626105-5545-017	0.60	17.00	7.00	1.00	4.60	0.40
626105-5545-018	0.60	18.00	8.00	1.00	4.60	0.40
626105-5545-019	0.60	19.00	9.00	1.00	4.60	0.40
626105-5545-020	0.60	20.00	10.00	1.00	4.60	0.40
626105-5545-021	0.60	21.00	11.00	1.00	4.60	0.40
626105-5545-022	0.60	22.00	12.00	1.00	4.60	0.40
626105-5645-015	0.80	15.00	5.00	1.00	4.80	0.60
626105-5645-016	0.80	16.00	6.00	1.00	4.80	0.60
626105-5645-017	0.80	17.00	7.00	1.00	4.80	0.60
626105-5645-018	0.80	18.00	8.00	1.00	4.80	0.60
626105-5645-019	0.80	19.00	9.00	1.00	4.80	0.60
626105-5645-020	0.80	20.00	10.00	1.00	4.80	0.60
626105-5645-021	0.80	21.00	11.00	1.00	4.80	0.60
626105-5645-022	0.80	22.00	12.00	1.00	4.80	0.60
626115-0082-022	0.80	22.30	12.30	1.00	4.80	0.60
626105-5645-023	0.80	23.00	13.00	1.00	4.80	0.60
626105-5645-024	0.80	24.00	14.00	1.00	4.80	0.60
626105-5645-025	0.80	25.00	15.00	1.00	4.80	0.60
626105-5645-026	0.80	26.00	16.00	1.00	4.80	0.60
626105-5645-027	0.80	27.00	17.00	1.00	4.80	0.60
626105-5645-028	0.80	28.00	18.00	1.00	4.80	0.60
626105-5645-029	0.80	29.00	19.00	1.00	4.80	0.60
626105-5645-030	0.80	30.00	20.00	1.00	4.80	0.60
626105-5645-031	0.80	31.00	21.00	1.00	4.80	0.60
626105-5645-032	0.80	32.00	22.00	1.00	4.80	0.60
626105-5645-033	0.80	33.00	23.00	1.00	4.80	0.60
626105-5645-034	0.80	34.00	24.00	1.00	4.80	0.60
626105-5645-035	0.80	35.00	25.00	1.00	4.80	0.60
626115-0085-035	0.80	35.00	25.00	1.00	15.00	0.60
626105-5645-036	0.80	36.00	26.00	1.00	4.80	0.60
626105-5645-037	0.80	37.00	27.00	1.00	4.80	0.60
626105-0045-015	1.00	15.00	5.00	0.80	5.00	0.80



Article-No.	DK	L	ML	DS	MLE	DSE
626105-0045-016	1.00	16.00	6.00	1.00	5.00	0.80
626105-0045-017	1.00	17.00	7.00	1.00	5.00	0.80
626105-0045-018	1.00	18.00	8.00	1.00	5.00	0.80
626105-0045-019	1.00	19.00	9.00	1.00	5.00	0.80
626105-0045-020	1.00	20.00	10.00	1.00	5.00	0.80
626115-0103-020	1.00	20.00	10.00	1.00	5.00	0.70
626105-0045-021	1.00	21.00	11.00	1.00	5.00	0.80
626105-0045-022	1.00	22.00	12.00	1.00	5.00	0.80
626115-0103-022	1.00	22.00	13.00	1.00	5.00	0.80
626115-0104-022	1.00	22.50	12.50	1.00	5.00	0.80
626105-0045-023	1.00	23.00	13.00	1.00	5.00	0.80
626105-0045-024	1.00	24.00	14.00	1.00	5.00	0.80
626105-0045-025	1.00	25.00	15.00	1.00	5.00	0.80
626105-0045-026	1.00	26.00	16.00	1.00	5.00	0.80
626105-0045-027	1.00	27.00	17.00	1.00	5.00	0.80
626105-0045-028	1.00	28.00	18.00	1.00	5.00	0.80
626105-0045-029	1.00	29.00	19.00	1.00	5.00	0.80
626105-0045-030	1.00	30.00	20.00	1.00	5.00	0.80
626115-0103-030	1.00	30.00	20.00	2.00	10.00	0.80
626105-0045-031	1.00	31.00	21.00	1.00	5.00	0.80
626105-0045-032	1.00	32.00	22.00	1.00	5.00	0.80
626105-0045-033	1.00	33.00	23.00	1.00	5.00	0.80
626105-0045-034	1.00	34.00	24.00	1.00	5.00	0.80
626105-0045-035	1.00	35.00	25.00	1.00	5.00	0.80
626115-0105-035	1.00	35.00	25.00	1.00	5.00	0.70
626105-0045-036	1.00	36.00	26.00	1.00	5.00	0.80
626105-0045-037	1.00	37.00	27.00	1.00	5.00	0.80
626105-0045-038	1.00	38.00	28.00	1.00	5.00	0.80
626105-0045-039	1.00	39.00	29.00	1.00	5.00	0.80
626105-0045-040	1.00	40.00	30.00	1.00	5.00	0.80
626115-0101-040	1.00	40.00	30.00	2.00	20.00	0.80
626115-0103-040	1.00	40.00	30.00	1.00	15.00	0.80
626105-0045-041	1.00	41.00	31.00	1.00	5.00	0.80
626105-0045-042	1.00	42.00	32.00	1.00	5.00	0.80
626115-0142-032	1.35	32.00	22.00	4.00	12.00	1.00
626115-0140-044	1.35	44.00	34.00	4.00	19.00	1.00
626115-0151-030	1.50	30.00	19.00	1.50	8.00	1.00
626115-0154-032	1.50	32.00	22.00	4.00	12.00	1.00
626115-0150-032	1.50	32.00	22.00	4.00	12.00	1.00
626115-0154-044	1.50	44.00	34.00	4.00	24.00	1.00
626115-0151-044	1.50	44.00	34.00	4.00	19.00	1.00
626115-0154-060	1.50	60.00	46.00	3.00	35.00	1.00
626115-0152-075	1.50	75.00	65.00	2.00	20.00	1.00
626115-0200-032	2.00	32.00	22.00	4.00	12.00	1.50
626115-0203-044	2.00	44.00	34.00	4.00	19.00	1.50
626115-0204-058	2.00	58.00	48.00	4.00	33.00	1.00
626115-0205-058	2.00	58.00	48.00	4.00	33.00	1.50
626115-0203-065	2.00	65.00	55.00	4.00	45.00	1.50
626115-0200-072	2.00	72.00	62.00	4.00	47.00	1.50
626115-0202-110	2.00	110.00	100.00	3.00	40.00	1.50
626115-0200-120	2.00	120.00	110.00	4.00	50.00	1.50



<b>Article-No.</b>	<b>DK</b>	<b>L</b>	<b>ML</b>	<b>DS</b>	<b>MLE</b>	<b>DSE</b>
626115-0201-180	2.00	180.00	167.00	6.00	10.00	1.50
626115-0250-032	2.50	32.00	22.00	4.00	12.00	1.50
626115-0251-032	2.50	32.00	22.00	4.00	12.00	1.00
626115-0250-044	2.50	44.00	34.00	4.00	19.00	1.50
626115-0252-044	2.50	44.00	34.00	4.00	19.00	1.00
626115-0250-058	2.50	58.00	48.00	4.00	33.00	1.50
626115-0252-093	2.50	93.00	83.00	3.00	33.00	1.50
626115-0303-068	3.00	68.00	58.00	4.00	45.00	2.00
626115-0312-100	3.00	100.00	90.00	4.00	60.00	2.00
626115-0300-103	3.00	103.00	93.00	4.00	68.00	2.00
626115-0304-105	3.00	105.00	95.00	4.00	40.00	2.00
626115-0303-110	3.00	110.00	100.00	4.00	60.00	2.00
626115-0304-112	3.00	112.00	99.00	5.00	71.00	2.00
626115-0304-115	3.00	115.00	102.00	5.00	60.00	2.00
626115-0305-115	3.00	115.00	99.00	3.00	24.00	2.00
626115-0303-130	3.00	130.00	120.00	2.50	70.00	1.50
626115-0305-130	3.00	130.00	120.00	2.50	40.00	1.50
626115-0301-163	3.00	163.00	150.00	5.00	30.00	2.00
626115-0353-115	3.50	115.00	102.00	5.00	75.00	2.50
626115-0501-075	5.00	75.00	65.00	3.50	25.00	1.50

# Diamond!Scan®

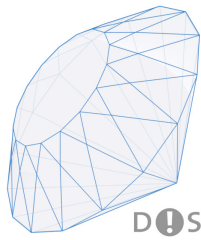

The ZEISS Diamond!Scan® portfolio has been specially developed for scanning ultra-hard ceramic surfaces or ultra-soft aluminum alloys. It is comprised of diamond or diamond-coated ball elements. ZEISS Diamond!Scan spheres are free from material and wear, so these styli can be used reliably in continuous operation without the need for time-consuming inspection and cleaning. The higher purchase price can thus be amortized quickly by the resulting time savings. ZEISS Diamond!Scan styli are available in 3 different versions, pure, carbo and mono. This ensures that you always have the right stylus available for your specific application.

## M5, Styli straight, diamond coated sphere, tungsten carbide shaft

Diamond coated styli with sphere and shaft made of one piece for the highest stability and accuracy. M5 thread for VAST active scanning sensors.

Connection Type: M5  
 Shaft Material: Tung. Carb.  
 Stylus Tip Geometry: Sphere-Segment  
 Stylus Tip Material: Diamond Coated  
 Ø Body (DG): 11

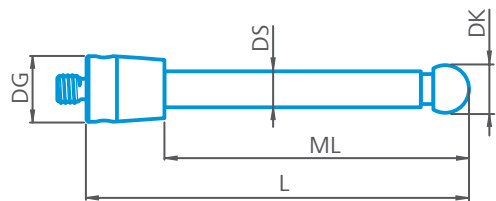

Article-No.	DK	L	ML	DS
626115-0129-015	1.00	15.00	5.00	0.80
626115-0029-029	1.00	29.00	20.00	0.70
626115-0529-032	1.35	32.00	22.00	1.00
626115-0029-017	1.50	17.00	7.00	1.00
626115-0529-022	1.50	22.00	12.00	1.00
626115-0629-030	1.50	30.00	20.00	1.00
626115-0629-032	1.50	32.00	22.00	1.00
626115-0329-040	1.50	40.00	30.00	1.00
626115-0129-070	1.50	70.00	60.00	1.00
626115-0029-034	2.00	34.00	24.00	1.50
626115-0229-040	2.00	40.00	30.00	1.50
626115-0129-043	2.00	43.00	33.00	1.50
626115-0329-050	2.00	50.00	40.00	1.50
626115-0529-058	2.00	58.00	48.00	1.50
626115-0029-060	2.00	60.00	50.00	1.50
626115-0829-075	2.00	75.00	65.00	1.50
626115-0129-033	2.50	33.00	23.00	1.50
626115-0129-017	3.00	17.00	7.00	2.00
626115-0029-022	3.00	22.00	12.00	2.00
626115-0129-025	3.00	25.00	15.00	2.00
626115-0029-026	3.00	26.00	16.00	2.00
626115-0129-029	3.00	29.00	19.00	2.00
626115-1129-032	3.00	32.00	22.00	2.00
626115-0029-033	3.00	33.00	23.00	2.00



Article-No.	DK	L	ML	DS
626115-0729-033	3.00	33.00	23.00	2.00
626115-0129-034	3.00	33.50	23.50	2.00
626115-0429-040	3.00	40.00	30.00	2.00
626115-0329-045	3.00	45.00	35.00	2.00
626115-0229-050	3.00	50.00	40.00	2.00
626115-0029-055	3.00	55.00	45.00	2.00
626115-0429-058	3.00	58.00	48.00	2.00
626115-0029-062	3.00	62.00	52.00	2.00
626115-0229-064	3.00	64.00	54.00	2.00
626115-0429-075	3.00	75.00	65.00	2.00
626115-0029-085	3.00	85.00	75.00	2.00
626115-0429-100	3.00	100.00	90.00	2.00
626115-0629-058	3.50	58.00	48.00	2.00
626115-0229-033	4.00	33.00	23.00	3.00
626115-0429-033	4.00	33.00	23.00	2.00
626115-0129-040	4.00	40.00	30.00	3.00
626115-0929-040	4.00	40.00	30.00	2.00
626115-0129-050	4.00	50.00	40.00	3.00
626115-0429-050	4.00	50.00	40.00	2.00
626115-0229-058	4.00	58.00	48.00	3.00
626115-0129-062	4.00	62.00	52.00	2.00
626115-0129-075	4.00	75.00	65.00	3.00
626115-0629-075	4.00	75.00	65.00	2.00
626115-0129-100	4.00	100.00	90.00	3.00
626115-0429-150	4.00	150.00	140.00	3.00
626115-0229-065	4.50	65.00	55.00	3.00
626115-0029-025	5.00	25.00	15.00	3.50
626115-0729-040	5.00	40.00	30.00	3.50
626115-0029-050	5.00	50.00	40.00	3.50
626115-0129-053	5.00	53.00	43.00	3.50
626115-0329-065	5.00	65.00	55.00	3.50
626115-0029-071	5.00	71.00	61.00	3.50
626115-0529-075	5.00	75.00	65.00	3.50
626115-0029-090	5.00	90.00	80.00	3.50
626115-0029-100	5.00	100.00	90.00	3.50
626115-0029-140	5.00	140.00	130.00	3.50
626115-0529-040	6.00	40.00	30.00	3.50
626115-0029-054	6.00	54.00	44.00	3.50
626115-0329-058	6.00	58.00	48.00	3.50
626115-0229-100	6.00	100.00	90.00	3.50
626115-0229-120	6.00	120.00	105.00	3.50
626115-0129-160	6.00	160.00	145.00	3.50
626115-0229-200	6.00	200.00	190.00	3.50
626115-0829-040	8.00	40.00	30.00	3.00
626115-0029-064	8.00	63.50	50.50	6.00
626115-0029-067	8.00	67.00	54.00	6.00
626115-0729-075	8.00	75.00	62.00	6.00
626115-0029-078	8.00	78.00	65.00	6.00
626115-0029-115	8.00	114.50	101.50	6.00
626115-0129-138	8.00	138.00	125.00	6.00
626115-0929-030	10.00	30.00	17.00	5.00
626115-0029-063	10.00	63.00	50.00	5.00
626115-0029-065	10.00	65.00	53.00	3.00
626115-0329-100	10.00	100.00	87.00	6.00



Article-No.	DK	L	ML	DS
626115-0129-150	10.00	150.00	125.00	6.00
626115-0029-165	10.00	165.00	152.00	6.00
626115-0129-200	10.00	200.00	175.00	6.00

### M5, Styli stepped, diamond coated sphere, tungsten carbide shaft

Diamond coated styli with sphere and shaft made of one piece for the highest stability and accuracy. M5 thread for VAST active scanning sensors.

Connection Type: M5  
 Shaft Material: Tung. Carb.  
 Stylus Tip Geometry: Sphere-Segment  
 Stylus Tip Material: Diamond Coated  
 Ø Body (DG): 11

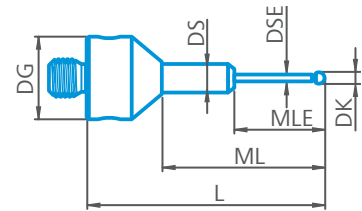

Article-No.	DK	L	ML	DS	MLE	DSE
626115-0129-020	0.50	20.00	9.65	1.00	3.60	0.40
626115-0229-022	0.50	22.00	12.00	1.00	2.50	0.30
626115-0129-024	0.50	24.00	14.00	1.00	2.50	0.30
626115-0329-032	0.50	32.00	22.00	1.00	2.50	0.30
626115-0329-022	0.80	22.00	12.00	1.00	4.80	0.50
626115-0429-032	0.80	32.00	22.00	1.00	4.80	0.50
626115-0129-035	0.80	35.00	25.00	1.00	10.00	0.70
626115-0729-022	1.00	22.00	12.00	1.00	5.00	0.80
626115-0129-044	1.35	44.00	34.00	4.00	19.00	1.00
626115-0029-032	1.50	32.00	22.00	4.00	12.00	1.00
626115-0229-044	1.50	44.00	34.00	4.00	19.00	1.00
626115-0429-045	1.50	45.00	35.00	4.00	20.00	1.00
626115-1029-032	2.00	32.00	22.00	4.00	12.00	1.50
626115-0629-044	2.00	44.00	34.00	4.00	19.00	1.50
626115-0029-058	2.00	58.00	48.00	4.00	33.00	1.50
626115-0829-032	2.50	32.00	22.00	4.00	12.00	1.50
626115-0129-058	2.50	58.00	48.00	4.00	33.00	1.50
626115-0729-058	3.00	58.00	48.00	4.00	33.00	2.00



## M5, Styli straight, diamond sphere, tungsten carbide shaft

Styli with a full diamond sphere for scanning applications were one side of the sphere is commonly used. M5 thread for VAST active scanning sensors.

Connection Type: M5  
 Shaft Material: Tung. Carb.  
 Stylus Tip Geometry: Sphere  
 Stylus Tip Material: Diamond  
 Ø Body (DG): 11

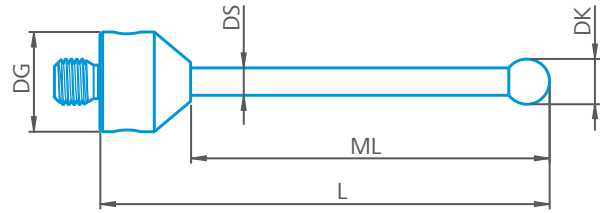

Article-No.	DK	L	ML	DS
626115-0209-020	2.00	20.00	10.00	1.50
626115-0209-034	2.00	34.00	24.00	1.50
626115-0209-050	2.00	50.00	40.00	1.50
626115-0309-020	3.00	20.00	10.00	2.00
626115-0309-025	3.00	25.00	15.00	2.00
626115-0309-033	3.00	33.00	23.00	2.00
626115-0309-036	3.00	36.00	26.00	2.00
626115-0309-040	3.00	40.00	30.00	2.00
626115-0309-050	3.00	50.00	40.00	2.00
626115-0319-058	3.00	58.00	48.00	2.50
626115-0309-058	3.00	58.00	48.00	2.00
626115-0309-064	3.00	64.00	54.00	2.00
626115-0309-075	3.00	75.00	65.00	2.00
626115-0309-090	3.00	90.00	80.00	2.50
626115-0309-100	3.00	100.00	90.00	2.00

## M5, Styli stepped, diamond sphere, tungsten carbide shaft

Styli with a full diamond sphere for scanning applications were one side of the sphere is commonly used. M5 thread for VAST active scanning sensors.

Connection Type: M5  
 Shaft Material: Tung. Carb.  
 Stylus Tip Geometry: Sphere  
 Stylus Tip Material: Diamond  
 Ø Body (DG): 11

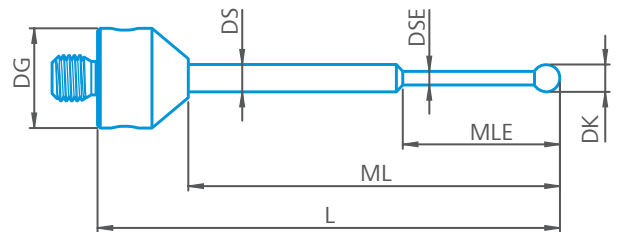

Article-No.	DK	L	ML	DS	MLE	DSE
626115-0109-022	1.00	22.00	12.00	1.00	5.00	0.80
626115-0109-024	1.00	24.00	14.00	1.00	5.00	0.80
626115-0229-032	2.00	32.00	22.00	4.00	12.00	1.50
626115-0209-032	2.00	32.00	22.00	4.00	12.00	1.50
626115-0209-044	2.00	44.00	34.00	4.00	19.00	1.50
626115-0209-058	2.00	58.00	48.00	4.00	33.00	1.50

## L-styli and -elements

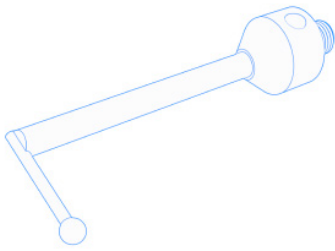

With L styli, by default the stylus tip is at a 90° angle to the stylus shaft. Due to their L shape, the styli are particularly well-suited for measuring undercuts in bores. Furthermore, an L stylus can also be used to measure difficult-to-reach points (e.g. on the underside of the workpiece). In addition to the 90° angle, other angular positions are also possible

### M5, L-styli straight, ruby sphere, tungsten carbide shaft

L-styli for measuring undercuts and horizontal bores. M5 thread for VAST active scanning sensors.

Connection Type: M5  
 Shaft Material: Tung. Carb.  
 Stylus Tip Geometry: Sphere  
 Stylus Tip Material: Ruby  
 Ø Body (DG): 11

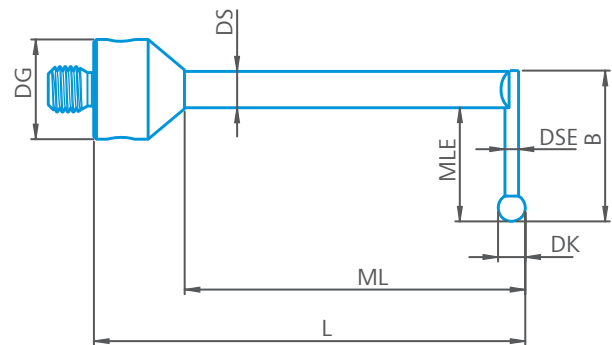

Article-No.	DK	L	ML	DS	MLE	DSE	B
626115-5000-864	0.30	35.15	25.15	2.00	2.00	0.20	4.00
626115-5000-383	0.50	30.00	20.00	1.00	1.50	0.40	2.50
626115-5000-665	0.50	30.00	20.00	1.00	1.00	0.40	2.00
626115-5000-710	0.50	39.45	29.45	2.00	3.50	0.40	5.50
626115-5000-655	0.50	40.00	30.00	4.00	4.00	0.30	8.00
626115-5000-399	0.50	80.00	70.00	2.00	4.25	0.30	6.25
626115-5000-499	0.60	40.00	30.00	3.00	3.50	0.40	6.50
626115-5000-763	0.80	45.00	35.00	4.00	8.80	0.60	12.80
626115-5000-882	0.80	49.00	39.00	4.00	4.50	0.50	8.50
626115-5000-419	0.80	90.00	80.00	3.00	6.00	0.50	9.00
626115-5000-356	1.00	30.00	20.00	2.50	1.50	0.80	2.50
626115-5000-425	1.00	30.00	20.00	1.00	2.00	0.80	3.00
626115-5000-318	1.00	50.00	40.00	2.00	6.00	0.50	8.00
626115-5000-831	1.00	50.00	40.00	1.00	1.50	0.80	2.50
626115-5000-690	1.00	60.00	50.00	6.00	5.00	0.80	11.00
626115-5000-379	1.00	70.50	60.50	3.00	3.25	0.50	6.25
626115-5000-940	1.00	80.00	70.00	2.00	5.00	0.80	7.00
626115-5000-873	1.50	26.75	16.75	2.00	6.30	0.80	8.30
626115-5000-467	1.50	27.00	17.00	3.00	4.00	1.00	7.00
626115-5000-706	1.50	35.70	25.70	3.00	13.00	1.20	16.00
626115-5000-476	1.50	40.75	30.75	3.00	7.00	1.00	10.00
626115-5000-532	1.50	41.15	31.15	3.00	10.50	1.20	13.50
626115-5000-681	1.50	60.00	50.00	4.00	10.50	1.00	14.50



<b>Article-No.</b>	<b>DK</b>	<b>L</b>	<b>ML</b>	<b>DS</b>	<b>MLE</b>	<b>DSE</b>	<b>B</b>
626115-5000-639	1.50	103.25	90.25	5.00	5.05	1.00	10.05
626115-5000-857	1.50	135.00	122.00	5.00	4.50	1.00	9.50
626115-5000-683	1.60	80.00	67.00	8.00	7.20	1.00	16.00
626115-5000-819	2.00	41.00	31.00	2.00	4.00	1.50	6.00
626115-5000-624	2.00	41.50	31.50	4.00	15.00	1.50	19.00
626115-5000-904	2.00	45.00	35.00	2.00	8.00	1.00	10.00
626115-5000-540	2.00	45.25	35.25	4.00	19.00	1.50	23.00
626115-5000-609	2.00	50.00	40.00	4.00	27.00	1.50	31.00
626115-5000-546	2.00	51.00	41.00	3.00	7.50	1.50	10.50
626115-5000-614	2.00	51.00	41.00	3.00	9.00	1.00	12.00
626115-5000-455	2.00	80.50	71.00	2.00	5.00	1.00	7.00
626115-5000-603	2.50	52.25	42.25	4.00	14.50	1.50	18.50
626115-5000-611	3.00	31.50	21.20	4.00	18.00	2.00	22.00
626115-5000-610	3.00	31.50	21.50	6.00	41.00	2.50	47.00
626115-5000-612	3.00	37.50	27.50	4.00	18.00	2.00	22.00
626115-5000-156	3.00	41.50	28.50	6.00	35.50	2.00	41.50
626115-5000-623	3.00	43.00	33.00	4.00	9.00	2.00	13.00
626115-5000-347	3.00	50.00	37.00	6.00	9.00	1.50	15.00
626115-0300-050	3.00	50.00	50.00	11.00	28.00	2.00	39.00
626115-5000-625	3.00	51.50	38.50	5.00	23.00	2.00	28.00
626115-5000-533	3.00	51.50	41.50	4.00	10.00	2.00	14.00
626115-5000-876	3.00	52.50	42.50	4.00	14.00	2.00	18.00
626115-5000-642	3.00	60.00	50.00	4.00	26.20	2.00	29.85
626115-5000-935	3.00	66.50	53.50	5.00	17.00	2.00	22.00
626115-5000-061	3.00	67.00	60.00	2.50	12.00	2.00	14.50
626115-5000-478	3.00	81.50	71.50	4.00	31.00	2.00	35.00
626115-5000-963	3.50	80.00	70.00	4.00	13.00	2.00	17.00
626115-5000-981	3.50	119.75	109.75	4.00	13.00	2.00	17.00
626115-5000-959	3.97	61.00	51.00	5.00	9.00	2.00	14.00
626115-5000-875	4.00	79.50	69.50	6.00	37.00	3.00	43.00
626115-5000-953	5.00	25.00	15.00	3.00	22.00	2.00	25.00
626115-5000-456	5.00	82.50	72.50	4.00	6.00	3.00	10.00
626115-5000-883	6.00	74.25	61.25	6.00	9.00	3.50	15.00
626115-5000-835	6.00	103.00	93.00	4.00	17.00	3.00	21.00
626115-5000-808	6.00	105.00	95.00	4.00	22.00	2.50	26.00
626115-5000-809	6.00	115.00	105.00	4.00	22.00	2.50	26.00
626115-5000-836	6.00	118.00	108.00	4.00	17.00	3.00	21.00
626115-5000-468	7.00	63.00	50.00	6.00	10.00	4.00	16.00
626115-5000-748	7.00	71.50	61.50	6.00	12.00	4.00	18.00
626115-5000-099	8.00	15.00	15.00	11.00	11.00	6.00	22.00
626115-5000-470	8.00	63.00	50.00	6.00	10.00	4.00	16.00
626115-5000-749	8.00	72.00	62.00	6.00	16.00	4.00	22.00
626115-5000-914	10.00	65.00	55.00	4.00	18.00	4.00	22.00

### M5, L-styli stepped, ruby sphere, tungsten carbide shaft

L-styli for measuring undercuts and horizontal bores. M5 thread for VAST active scanning sensors.

Connection Type: M5  
 Shaft Material: Tung. Carb.  
 Stylus Tip Geometry: Sphere  
 Stylus Tip Material: Ruby  
 Ø Body (DG): 11

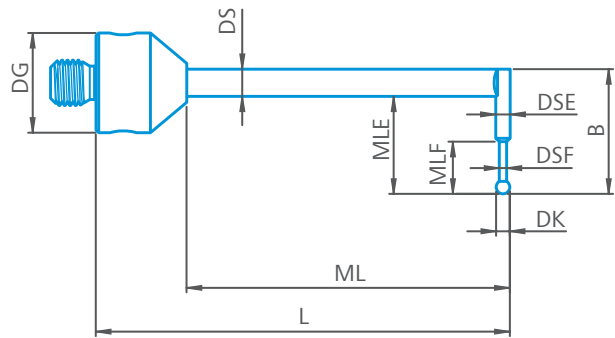

Article-No.	DK	L	ML	DS	MLE	MLF	DSE	B
626115-5000-869	0.30	39.00	29.00	1.50	3.50	1.25	0.50	5.00
626115-5000-851	0.50	48.25	38.25	4.00	10.40	2.4	1.50	14.40
626115-5000-818	0.60	51.80	41.80	2.00	7.80	1.3	1.50	2.80
626115-5000-923	0.60	54.80	44.80	2.00	19.85	1.27	1.50	2.77
626115-5000-868	0.70	39.35	29.35	1.50	10.85	3.6	0.80	12.35

### M5, L-styli straight, silicon nitride sphere, tungsten carbide shaft

L-styli for measuring undercuts and horizontal bores. M5 thread for VAST active scanning sensors.

Connection Type: M5  
 Shaft Material: Tung. Carb.  
 Stylus Tip Geometry: Sphere  
 Stylus Tip Material: Si. Nitride  
 Ø Body (DG): 11

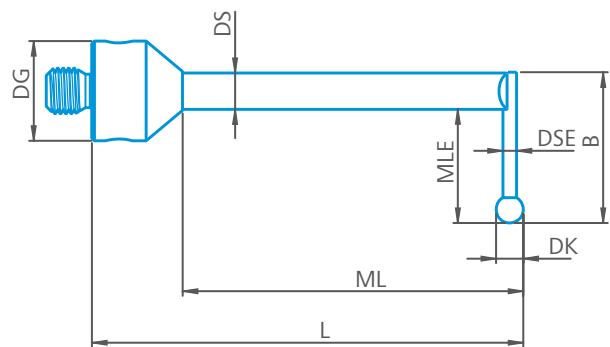

Article-No.	DK	L	ML	DS	MLE	DSE	B
626115-5000-538	2.00	70.00	60.00	4.00	17.00	1.00	21.00
626115-5000-490	2.50	52.25	42.25	4.00	14.50	1.50	18.50
626115-5000-488	3.00	71.50	61.50	5.00	19.00	2.00	24.00
626115-5000-969	6.00	53.00	43.00	4.00	28.00	4.00	32.00

## M5, L-styli angled straight, ruby sphere, tungsten carbide shaft

Angled L-styli for measuring undercuts and angled bores. M5 thread for VAST active scanning sensors.

Connection Type: M5  
 Shaft Material: Tung. Carb.  
 Stylus Tip Geometry: Sphere  
 Stylus Tip Material: Ruby  
 Ø Body (DG): 11

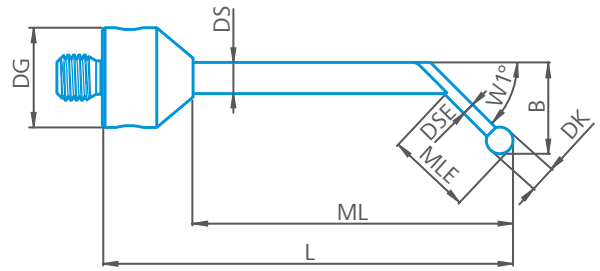

Article-No.	DK	L	ML	DS	MLE	DSE	B	W1
626115-5000-893	0.50	40.00	30.00	3.00	4.00	0.40	7.00	10.00
626115-5000-833	0.80	40.00	30.00	4.00	5.00	0.60	9.00	45.00
626115-5000-359	0.80	40.40	30.40	2.00	2.60	0.60	3.90	45.00
626115-5000-682	1.50	50.75	40.75	3.50	12.25	1.00	15.60	75.00
626115-5000-662	1.50	50.75	40.75	3.50	12.25	1.00	6.74	15.00
626115-5000-569	2.00	51.70	41.70	4.00	7.00	1.50	7.33	30.00
626115-5000-837	2.50	69.25	59.25	4.00	11.25	1.50	15.25	24.00
626115-5000-849	2.50	69.75	59.75	4.00	11.75	1.50	15.75	30.00
626115-5000-896	3.00	52.20	42.20	2.00	13.10	2.00	15.00	87.00
626115-5000-428	3.00	58.00	48.00	2.50	13.50	2.00	16.00	82.20
626115-5000-708	3.00	58.00	48.00	3.50	13.60	2.00	16.60	45.00
626115-5000-897	3.00	60.70	50.70	2.00	14.00	2.00	12.50	50.80
626115-5000-547	3.00	65.00	44.00	4.00	12.50	2.00	16.50	85.00
626115-5000-509	3.00	75.00	62.00	5.00	8.50	2.00	20.00	45.00
626115-5000-948	3.00	88.80	78.80	3.00	12.00	2.00	12.90	59.00
626115-5000-909	3.00	90.70	80.70	3.00	13.30	2.00	13.00	51.00
626115-5000-520	3.00	119.50	109.50	4.00	17.29	2.00	17.80	55.00
626115-5000-521	3.00	175.50	165.50	4.00	19.20	2.00	17.30	45.00

## M5, L-styli angled stepped, ruby sphere, tungsten carbide shaft

Angled L-styli for measuring undercuts and angled bores. M5 thread for VAST active scanning sensors.

Connection Type: M5  
 Shaft Material: Tung. Carb.  
 Stylus Tip Geometry: Sphere  
 Stylus Tip Material: Ruby  
 Ø Body (DG): 11

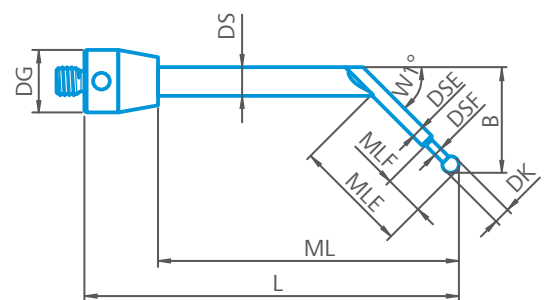

Article-No.	DK	L	ML	DS	MLE	MLF	DSE	B	W1
626115-5000-947	0.50	44.50	34.50	3.50	12.80	2.8	1.50	6.00	15.00
626115-5000-870	0.50	46.80	36.80	1.50	10.00	3.3	0.80	9.50	55.00

## T-styli and -elements

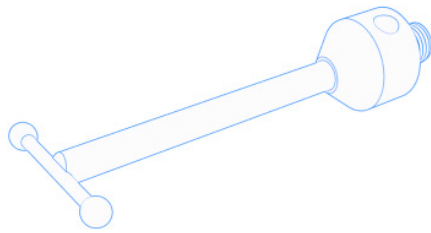

T-styli consist of two opposing measuring probe spheres mounted at 90° to the shaft. These styli are particularly suitable for measuring opposing holes and undercuts, such as grooves. In addition, T-styli can also be used for measuring points that are difficult to access (e.g. on the underside of the workpiece).

### M5, T-styli straight, ruby sphere, tungsten carbide shaft

T-styli for measuring opposing bores, grooves, undercuts, cylinder and bore diameters. M5 thread for VAST active scanning sensors.

Connection Type: M5  
 Shaft Material: Tung. Carb.  
 Stylus Tip Geometry: Sphere  
 Stylus Tip Material: Ruby  
 Ø Body (DG): 11

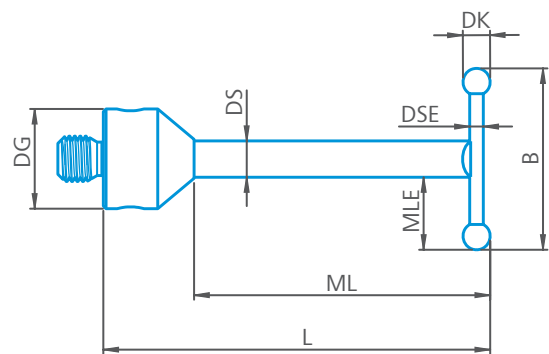

Article-No.	DK	L	ML	DS	MLE	DSE	B
626115-5000-865	0.30	28.40	15.40	8.00	3.50	0.20	15.00
626115-5000-518	0.50	25.25	15.25	1.50	3.00	0.30	4.50
626115-5000-845	0.50	40.00	30.00	3.00	4.00	0.40	11.00
626115-5000-426	0.50	70.00	60.00	2.00	2.50	0.40	7.00
626115-5000-562	0.60	15.60	5.60	2.00	1.40	0.40	4.80
626115-5000-394	0.60	32.50	22.00	2.00	1.65	0.40	5.30
626115-5000-978	0.80	20.40	10.40	2.00	2.40	0.60	6.80
626115-5000-044	1.00	44.50	30.50	5.00	6.00	0.80	17.00
626115-5000-952	1.00	49.50	39.50	2.00	2.50	0.40	7.00
626115-5000-817	1.35	32.20	22.20	3.00	3.00	1.00	9.00
626115-5000-188	1.35	35.41	35.41	2.20	3.57	0.80	9.35
626115-5000-469	1.35	50.00	40.00	2.00	4.00	1.00	10.00
626115-5000-422	1.50	45.75	35.75	3.50	7.25	1.00	18.00
626115-5000-667	1.50	50.00	40.00	4.00	14.00	1.00	32.00
626115-5000-335	1.50	60.00	49.00	5.00	8.75	1.00	22.50
626115-5000-834	2.00	31.00	21.00	5.00	4.50	1.50	14.00
626115-5000-568	2.00	50.00	40.00	3.00	5.50	1.00	14.00
626115-5000-354	2.00	61.00	51.00	4.00	9.00	1.50	22.00
626115-5000-111	2.00	61.00	46.00	5.00	9.50	1.50	24.00
626115-5000-056	2.30	51.15	41.15	4.00	6.00	1.00	16.00
626115-5000-583	2.50	92.00	82.00	4.00	3.75	1.50	11.10
626115-5000-268	3.00	23.00	13.50	4.00	28.00	1.50	60.00
626115-5000-613	3.00	39.50	29.50	4.00	38.00	2.00	80.00



Article-No.	DK	L	ML	DS	MLE	DSE	B
626115-5000-064	4.00	72.00	62.00	4.00	10.00	2.00	24.00
626115-5000-859	6.00	52.00	42.00	3.50	14.50	2.00	31.00

### M5, T-styli stepped, ruby sphere, tungsten carbide shaft

T-styli for measuring opposing bores, grooves, undercuts, cylinder and bore diameters. M5 thread for VAST active scanning sensors.

Connection Type: M5  
 Shaft Material: Tung. Carb.  
 Stylus Tip Geometry: Sphere  
 Stylus Tip Material: Ruby  
 Ø Body (DG): 11

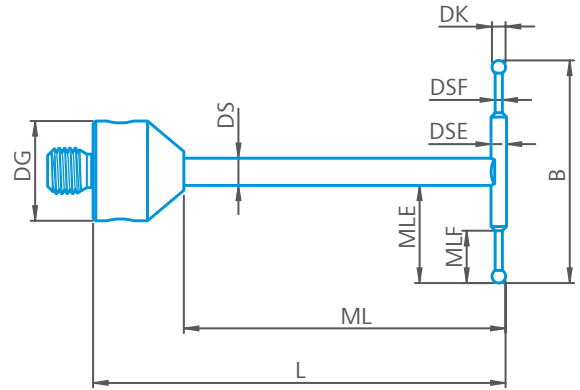

Article-No.	DK	L	ML	DS	MLE	MLF	DSE	B
626115-5000-723	0.50	25.25	15.25	3.00	8.00	3	1.00	19.00
626115-5000-903	3.00	64.50	54.50	5.00	9.75	14	2.00	28.75

### M5, T-styli straight, silicon nitride sphere, tungsten carbide shaft

T-styli for measuring opposing bores, grooves, undercuts, cylinder and bore diameters. M5 thread for VAST active scanning sensors.

Connection Type: M5  
 Shaft Material: Tung. Carb.  
 Stylus Tip Geometry: Sphere  
 Stylus Tip Material: Si. Nitride  
 Ø Body (DG): 11

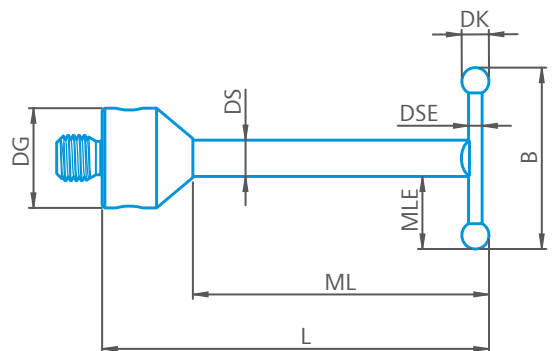

Article-No.	DK	L	ML	DS	MLE	DSE	B
626115-5000-411	2.50	46.25	33.25	6.00	7.00	1.50	20.00

## Star styli and -elements

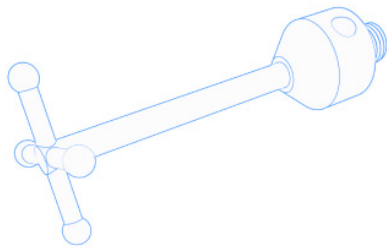

Star styli consist of spherical styli combined in a star shape and enable measurements in different coordinate directions. Where as probing with spherical styli from the side surfaces is only possible to a limited extent, with the star stylus you can select the stylus for probing that is orthogonal to the probed surface.

### M5, Star styli straight, ruby sphere, tungsten carbide shaft

Star styli for measuring bores, grooves, undercuts, cylinder and bore diameters instead of disc styli. M5 thread for VAST active scanning sensors.

Connection Type: M5  
 Shaft Material: Tung. Carb.  
 Stylus Tip Geometry: Sphere  
 Stylus Tip Material: Ruby  
 Ø Body (DG): 11

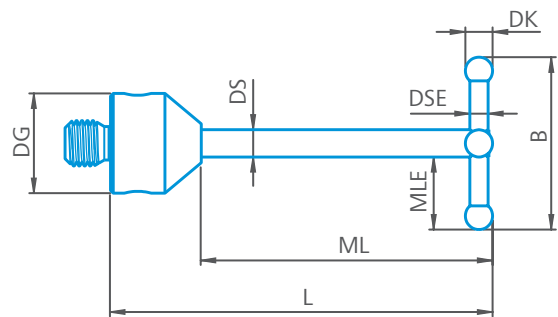

Article-No.	DK	L	ML	DS	MLE	DSE	B
626115-5000-034	0.50	25.00	15.00	4.00	2.00	0.30	8.00
626115-5000-503	0.50	40.25	30.25	4.00	2.00	0.30	8.00
626115-5000-592	0.50	50.00	40.00	4.00	2.00	0.40	8.00
626115-5000-591	0.50	90.25	80.25	4.00	4.25	0.40	12.50
626115-5000-395	0.60	25.00	15.00	4.00	2.00	0.50	8.00
626115-5000-910	1.00	43.00	30.00	5.00	4.00	0.70	13.00
626115-5000-752	1.35	60.00	50.00	4.00	8.00	1.00	20.00
626115-5000-886	1.75	64.88	51.88	6.00	7.00	1.00	20.00



## M5, Star styli straight, silicon nitride sphere, tungsten carbide shaft

Star styli for measuring bores, grooves, undercuts, cylinder and bore diameters instead of disc styli. M5 thread for VAST active scanning sensors.

Connection Type: M5  
 Shaft Material: Tung. Carb.  
 Stylus Tip Geometry: Sphere  
 Stylus Tip Material: Si. Nitride  
 Ø Body (DG): 11

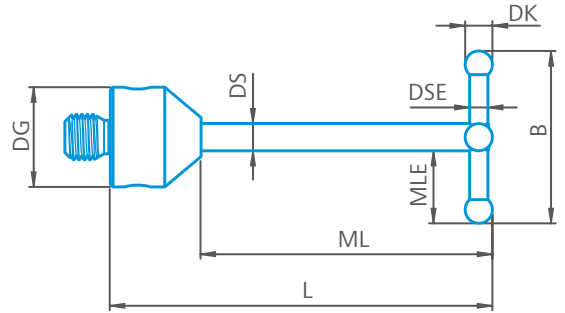

Article-No.	DK	L	ML	DS	MLE	DSE	B
626115-5000-462	1.00	48.00	38.00	4.00	3.75	0.50	11.50
626115-5000-484	1.00	140.00	130.00	4.00	4.00	0.50	12.00

## M5, Star styli straight, ruby sphere, steel shaft

Connection Type: M5  
 Shaft Material: Steel  
 Stylus Tip Geometry: Sphere  
 Stylus Tip Material: Ruby  
 Ø Body (DG): 11

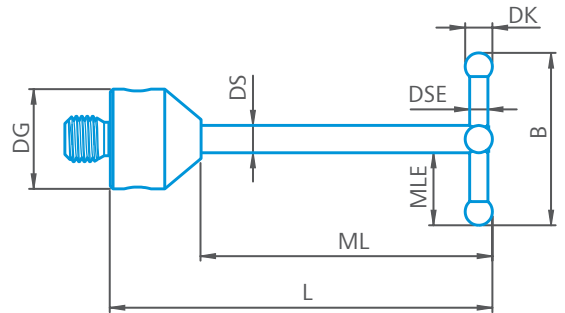

Article-No.	DK	L	ML	DS	MLE	DSE	B
626115-5000-919	0.50	50.00	40.00	4.00	2.00	0.30	8.00
626115-5000-010	0.60	25.00	15.00	4.00	2.00	0.40	8.00
626115-5000-916	0.60	50.00	40.00	4.00	2.00	0.40	8.00
626115-5000-926	1.00	50.00	40.00	4.00	4.00	0.60	12.00
626115-5000-942	1.20	50.00	40.00	4.00	2.00	0.80	8.00

### M5, Cube star styli straight, ruby sphere, tungsten carbide shaft

Cube star styli are standard elements to adapt directly to REACH extensions. Used for measuring bores, grooves, undercuts, cylinder and bore diameters instead of disc styli. Size 15 cube with M5 thread for VAST active scanning sensors.

Connection Type: M5  
 Shaft Material: Tung. Carb.  
 Stylus Tip Geometry: Sphere  
 Stylus Tip Material: Ruby

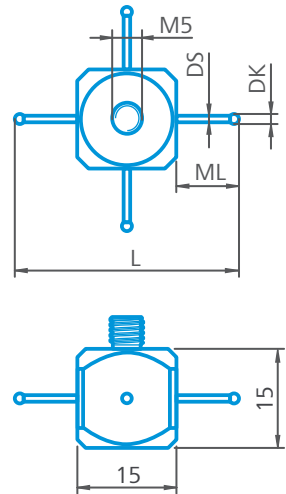

Article-No.	DK	L	ML	DS	B
626115-5000-564	1.50	32.00	8.50	1.00	15.00

### M5, Cube star styli stepped, ruby sphere, tungsten carbide shaft

Cube star styli are standard elements to adapt directly to REACH extensions. Used for measuring bores, grooves, undercuts, cylinder and bore diameters instead of disc styli. Size 15 cube with M5 thread for VAST active scanning sensors.

Connection Type: M5  
 Shaft Material: Tung. Carb.  
 Stylus Tip Geometry: Sphere  
 Stylus Tip Material: Ruby

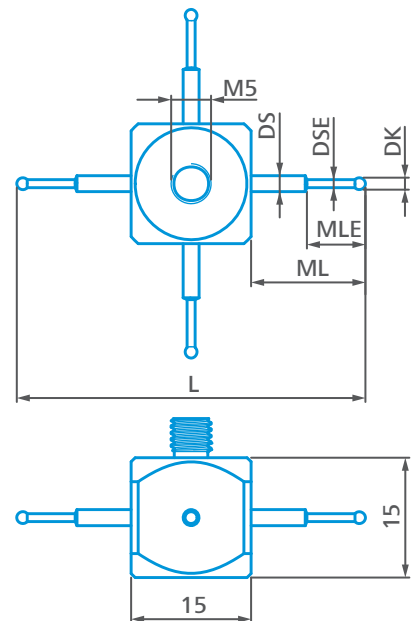

Article-No.	DK	L	ML	DS	MLE	DSE	B
602030-9024-000	1.00	45.00	15.00	2.00	7.00	0.80	15.00
626115-5000-327	1.00	45.00	15.00	8.00	11.00	0.80	15.00
626115-6110-009	1.00	45.00	15.00	4.00	8.00	0.70	15.00
602030-9025-000	1.50	45.00	15.00	2.00	6.50	1.00	15.00
602030-9026-000	2.00	45.00	15.00	2.00	7.00	1.50	15.00
602030-9027-000	2.50	45.00	15.00	2.00	8.00	1.50	15.00





<b>Article-No.</b>	<b>DK</b>	<b>L</b>	<b>ML</b>	<b>DS</b>	<b>MLE</b>	<b>DSE</b>	<b>B</b>
626115-6110-006	2.50	45.00	15.00	4.00	8.00	1.20	15.00
602030-9028-000	3.50	45.00	15.00	2.00	7.50	2.00	15.00

## Cylinder styli

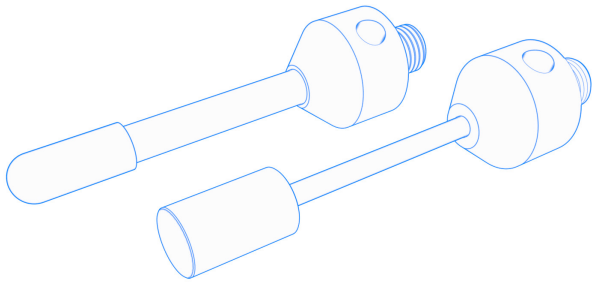

Cylindrical styli measure two-dimensionally and are particularly suitable for thin sheets. Narrow workpiece edges can also be measured well with cylindrical measuring probes. However, the probe axis must be mechanically aligned very precisely with the feature axis on the workpiece. As a special form, spherical cylindrical styli are available, which are also mostly used for sheet metal measurement and measurement at sheet metal edges. They have spherical end and can thus additionally determine the flatness of a surface, for example.

### M5, Cylinder styli, tungsten carbide cylinder, tungsten carbide shaft

Cylindrical styli for thin sheets and narrow workpiece edges. M5 thread for VAST active scanning sensors.

Connection Type: M5  
 Shaft Material: Tung. Carb.  
 Stylus Tip Geometry: Cylinder  
 Stylus Tip Material: Tung. Carb.  
 Ø Body (DG): 11

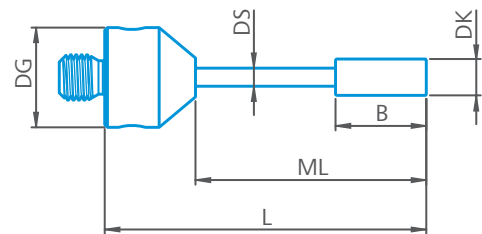

Article-No.	DK	L	ML	DS	B
626115-0020-012	0.20	12.00	2.00	0.30	1.00
626115-0153-025	1.50	25.00	15.00	1.00	1.50
626115-0201-020	2.00	20.00	9.00	1.00	7.00
626115-0203-025	2.00	25.00	15.00	1.50	5.00
626115-0200-031	2.00	31.00	20.00	1.00	7.20
626115-5000-020	2.00	50.00	40.00	1.50	15.00
626115-0205-050	2.00	50.00	40.00	1.50	8.50
626115-0204-050	2.00	50.00	40.00	1.50	35.00
626115-0251-034	2.50	34.00	23.00	1.50	3.00
626115-0305-025	3.00	25.00	11.00	2.00	6.00
626115-0302-040	3.00	40.00	30.00	1.50	8.00
626115-0300-045	3.00	45.00	34.00	2.00	8.00
626115-0305-050	3.00	50.00	40.00	2.00	5.00
626115-0303-060	3.00	60.00	50.00	2.00	6.00
626115-0300-062	3.00	62.00	52.00	2.50	10.00
626115-0301-073	3.00	73.00	63.00	2.50	10.00
626115-0300-073	3.00	73.00	60.00	2.40	10.00
626115-0310-080	3.00	80.00	70.00	2.00	6.00
626115-0370-050	3.75	50.00	40.00	2.00	10.00
626115-0400-053	4.00	53.00	43.00	3.50	6.00
626115-0404-060	4.00	60.00	50.00	3.00	10.00
626115-0500-035	5.00	35.00	25.00	3.50	5.00
626115-0503-040	5.00	40.00	30.00	2.00	2.00
626115-0507-040	5.00	40.00	30.00	2.50	5.00
626115-0509-050	5.00	50.00	40.00	3.00	10.00



Article-No.	DK	L	ML	DS	B
626115-0503-060	5.00	60.00	50.00	3.00	6.00
626115-0560-110	5.60	110.00	100.00	3.50	5.00
626115-0600-080	6.00	80.00	67.00	5.00	30.00
626115-0810-060	8.00	60.00	50.00	4.00	10.00
626115-0804-100	8.00	100.00	87.00	5.00	20.00

## M5, Cylinder styli, tungsten carbide cylinder, without shaft

Cylindrical styli for thin sheets and narrow workpiece edges. M5 thread for VAST active scanning sensors.

Connection Type: M5  
 Shaft Material: Tung. Carb.  
 Stylus Tip Geometry: Cylinder  
 Stylus Tip Material: Tung. Carb.  
 Ø Body (DG): 11

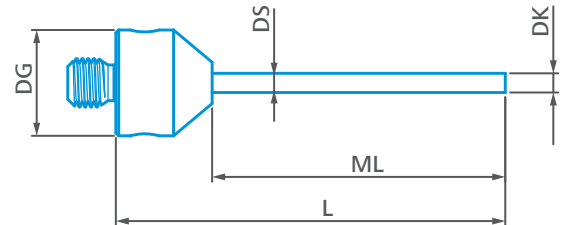

Article-No.	DK	L	ML	DS	B
626115-0102-025	1.00	25.00	14.00	1.00	14.00
626115-0107-035	1.00	35.00	25.00	1.00	25.00
626115-0104-050	1.00	50.00	40.00	1.00	40.00
626115-0151-020	1.50	20.00	10.00	1.50	10.00
626115-0151-033	1.50	33.00	23.00	1.50	23.00
626115-0150-050	1.50	50.00	40.00	1.50	40.00
626115-0201-025	2.00	25.00	15.00	2.00	15.00
626115-5000-374	2.00	45.00	35.00	2.00	35.00
626115-0201-045	2.00	45.00	35.00	2.00	45.00
626115-0201-085	2.00	85.00	75.00	2.00	75.00
626115-0300-013	3.00	13.00	4.00	3.00	4.00
626115-0304-050	3.00	50.00	40.00	3.00	40.00
626115-0301-060	3.00	60.00	50.00	3.00	50.00
626105-0300-077	3.00	77.00	67.00	3.00	67.00
626115-0351-080	3.50	80.00	70.00	3.50	70.00
626115-0402-020	4.00	20.00	10.00	4.00	10.00
626115-0501-040	5.00	40.00	30.00	5.00	30.00
626115-0603-055	6.00	55.40	42.40	6.00	42.40

### M5, Cylinder styli, ruby cylinder, tungsten carbide shaft

Cylindrical styli for thin sheets and narrow workpiece edges. M5 thread for VAST active scanning sensors.

Connection Type: M5  
 Shaft Material: Tung. Carb.  
 Stylus Tip Geometry: Cylinder  
 Stylus Tip Material: Ruby  
 Ø Body (DG): 11

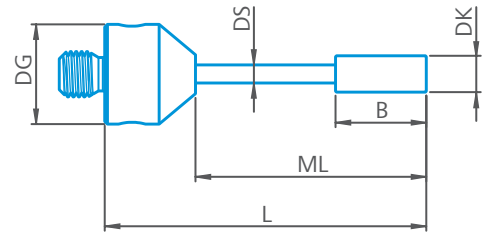

Article-No.	DK	L	ML	DS	B
626115-0303-034	3.00	33.75	23.75	1.00	1.50

### M5, Spherical cylinder styli, spherical ruby cylinder, tungsten carbide shaft

Cylindrical styli with sphere tip for thin sheets and narrow workpiece edges. In addition surface measurement with the spherical tip. M5 thread for VAST active scanning sensors.

Connection Type: M5  
 Shaft Material: Tung. Carb.  
 Stylus Tip Geometry: Spherical Cylinder  
 Stylus Tip Material: Ruby  
 Ø Body (DG): 11

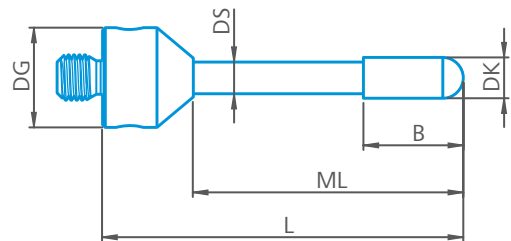

Article-No.	DK	L	ML	DS	B
626115-0203-020	2.00	20.00	10.00	1.00	7.50
626115-0202-030	2.00	30.00	20.00	1.50	7.20
626115-0205-060	2.00	60.00	50.00	1.00	7.50
626115-0302-058	3.00	58.00	37.00	2.00	10.00
626115-0403-025	4.00	25.00	15.00	2.00	10.00
626115-0406-030	4.00	30.00	21.00	2.00	10.00
626115-0500-058	5.00	58.00	37.00	3.00	10.00

## M5, Spherical cylinder styli, spherical tungsten carbide cylinder, tungsten carbide shaft

Cylindrical styli with sphere tip for thin sheets and narrow workpiece edges. In addition surface measurement with the spherical tip. M5 thread for VAST active scanning sensors.

Connection Type: M5  
 Shaft Material: Tung. Carb.  
 Stylus Tip Geometry: Spherical Cylinder  
 Stylus Tip Material: Tung. Carb.  
 Ø Body (DG): 11

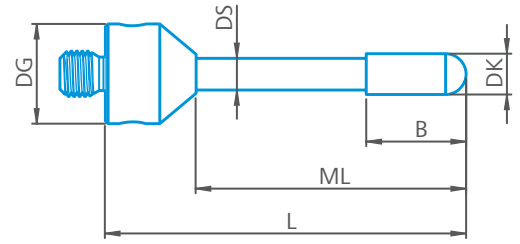

Article-No.	DK	L	ML	DS	B
626115-0303-050	3.00	50.00	40.00	1.50	10.00
626115-5000-921	5.00	80.00	70.00	4.00	15.00
626115-0780-110	7.78	110.00	97.00	5.00	6.00
626115-5000-922	8.00	105.00	92.00	5.00	15.00

## M5, Spherical cylinder styli, spherical tungsten carbide cylinder, without shaft

Cylindrical styli with sphere tip for thin sheets and narrow workpiece edges. In addition surface measurement with the spherical tip. M5 thread for VAST active scanning sensors.

Connection Type: M5  
 Shaft Material: Tung. Carb.  
 Stylus Tip Geometry: Spherical Cylinder  
 Stylus Tip Material: Tung. Carb.  
 Ø Body (DG): 11

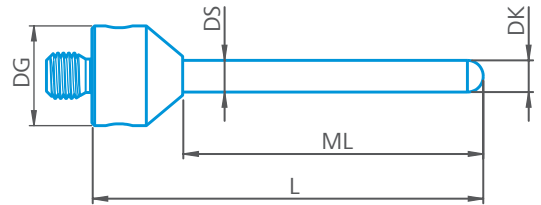

Article-No.	DK	L	ML	DS
626115-5000-812	1.00	40.00	30.00	1.00
626115-5000-140	2.00	22.00	12.00	2.00
626115-0302-060	3.00	60.00	50.00	3.00
626115-5000-863	4.00	35.00	25.00	4.00

## Disc styli

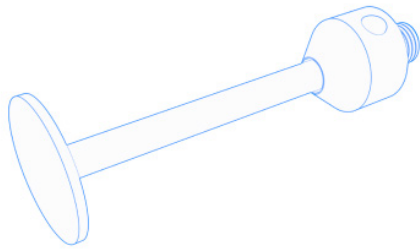

Disc styli are used, among other things, to measure rotationally symmetrical workpieces with undercuts or recesses and cylinders. However, a strong filtering of the surface roughness usually occurs. With the design of the spherical disk stylus, a higher accuracy is achieved compared to disk styli.

### M5, Disc styli, tungsten carbide disc, tungsten carbide shaft

Disc styli to measure rotationally symmetrical workpieces with undercuts or recesses and cylinders. M5 thread for VAST active scanning sensors.

Connection Type: M5  
 Shaft Material: Tung. Carb.  
 Stylus Tip Geometry: Disk  
 Stylus Tip Material: Tung. Carb.  
 Ø Body (DG): 11

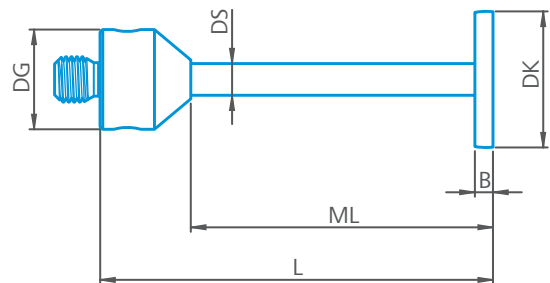

Article-No.	DK	L	ML	DS	B
626115-0158-030	1.50	30.00	20.00	1.00	0.30
626115-0221-030	2.20	30.00	20.00	1.00	0.40
626115-0252-030	2.50	30.00	20.00	1.00	0.30
626115-5000-964	3.00	30.75	20.75	1.00	0.75
626115-0402-030	4.00	30.00	20.00	2.50	0.80
626115-0406-075	4.00	75.00	65.00	1.00	0.50
626115-5000-705	6.00	40.00	30.00	2.00	1.00
626115-5000-860	6.00	50.00	40.00	3.00	3.00
626115-0600-050	6.00	50.00	40.00	2.00	1.00
626115-0700-030	7.00	30.00	20.00	2.50	0.80
626115-0702-040	7.00	40.00	30.00	2.50	0.80
626115-0700-085	7.00	85.00	75.00	3.00	1.00
626115-0800-033	8.00	33.00	23.00	3.00	2.00
626115-0802-040	8.00	40.00	30.00	3.00	0.80
626115-0801-057	8.00	57.00	47.00	2.50	1.00
626115-0800-065	8.00	65.00	54.00	3.00	0.80
626115-1000-030	10.00	30.00	20.00	6.00	0.70
626115-5000-858	10.00	65.00	52.00	5.00	2.00
626115-1001-070	10.00	70.00	60.00	3.50	1.10
626115-1201-053	12.00	52.50	42.50	4.00	0.75
626115-1403-065	14.00	65.00	55.00	3.50	2.00
626115-1500-051	15.00	51.00	40.00	2.00	1.00
626115-1506-065	15.00	65.00	55.00	3.50	1.00
626115-1500-073	15.00	72.50	62.50	4.00	1.00
626115-1500-088	15.00	88.00	75.00	5.00	1.00





Article-No.	DK	L	ML	DS	B
626115-1504-100	15.00	100.00	87.00	5.00	1.50
626115-1502-120	15.00	120.00	107.00	5.00	2.00
626115-5000-938	16.00	100.00	87.00	6.00	1.00
626115-1700-135	17.00	135.00	122.00	5.00	1.00
626115-1802-050	18.00	50.00	40.00	4.00	1.25
626115-1803-060	18.00	60.00	50.00	2.00	1.00
626115-2002-100	20.00	100.00	87.00	6.00	3.00

### M5, Disc styli, ceramic disc, tungsten carbide shaft

Disc styli to measure rotationally symmetrical workpieces with undercuts or recesses and cylinders. M5 thread for VAST active scanning sensors.

Connection Type: M5  
 Shaft Material: Tung. Carb.  
 Stylus Tip Geometry: Disk  
 Stylus Tip Material: Ceramic  
 Ø Body (DG): 11

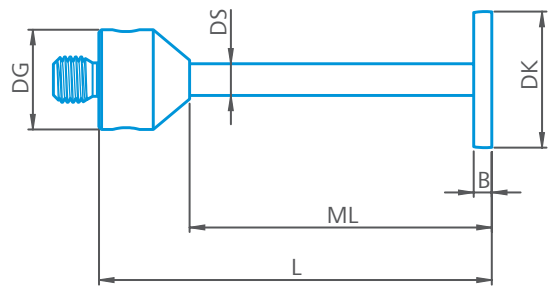

Article-No.	DK	L	ML	DS	B
626115-5000-820	20.00	66.00	56.00	6.00	1.00
626115-2501-065	25.00	65.00	52.00	5.50	1.20
626115-5000-822	25.00	95.00	82.00	6.00	1.00
626115-2600-071	26.00	71.00	58.00	5.00	8.00
626115-3004-120	30.00	120.00	107.00	8.00	1.00
626115-3000-170	30.00	170.00	160.00	5.00	1.00

### M5, Disc styli, stainless steel disc, aluminium shaft

Disc styli to measure rotationally symmetrical workpieces with undercuts or recesses and cylinders. M5 thread for VAST active scanning sensors.

Connection Type: M5  
 Shaft Material: Aluminium  
 Stylus Tip Geometry: Spherical Disk  
 Stylus Tip Material: Steel  
 Ø Body (DG): 7

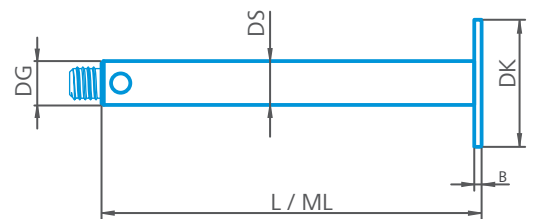

Article-No.	DK	L	ML	DS	B
600341-8090-000	10.00	21.50	21.50	7.00	1.50
000000-1165-629	15.00	40.00	40.00	7.00	1.00
602030-8091-000	20.00	60.00	60.00	7.00	1.00

# Discs



Discs are used, among other things, to measure rotationally symmetrical workpieces with undercuts or recesses and bores. However, a strong filtering of the surface roughness usually occurs. With the design of the spherical disc stylus, a higher accuracy is achieved compared to disc styli. Discs are screwed directly to extensions or special shafts using clamping disks. Normally, fastening material is not included in the delivery package

## M5, spherical disc, ceramic disc

Single disc to measure rotationally symmetrical workpieces with undercuts or recesses and cylinders. Stylus disks are primarily adapted to standard extensions.

Connection Type: M5  
 Stylus Tip Geometry: Spherical Disk  
 Stylus Tip Material: Ceramic

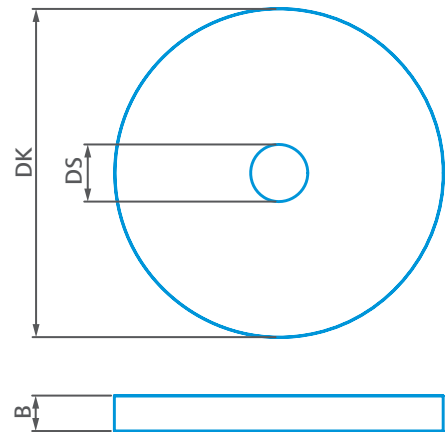

Article-No.	DK	DS	B
626101-3000-002	30.00	8.00	2.00
626101-6000-004	60.00	8.00	4.00

## M5, spherical disc, steel disc

Single disc to measure rotationally symmetrical workpieces with undercuts or recesses and cylinders. Stylus disks are primarily adapted to standard extensions.

Connection Type: M5  
 Stylus Tip Geometry: Disk  
 Stylus Tip Material: Steel

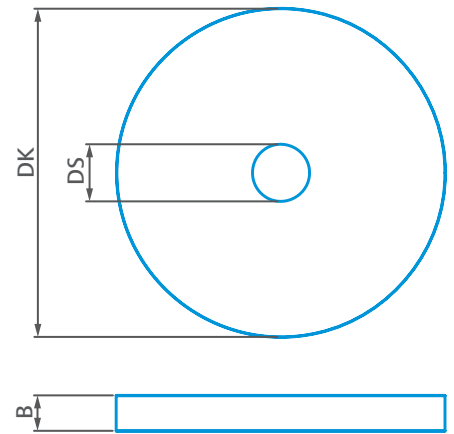

Article-No.	DK	DS	B
602030-0003-000	10.00	5.00	4.00
602030-0010-000	15.00	8.00	4.00
602030-0011-000	20.00	8.00	4.00
602030-0005-000	20.00	5.00	4.00
600341-0200-000	20.00	8.00	2.00
602030-0006-000	30.00	5.00	4.00
600341-0203-000	30.00	8.00	4.00
626115-5000-406	30.00	8.00	3.00
602030-0007-000	40.00	5.00	5.00
600341-0204-000	40.00	8.00	4.00
602030-0008-000	50.00	5.00	5.00
600341-0205-000	50.00	8.00	5.00
602030-0009-000	60.00	5.00	5.00
600341-0206-000	60.00	8.00	6.00

## Hemisphere styli

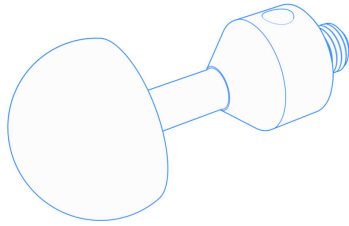

Hemisphere styli are suitable for measuring undercuts as well as for those applications that require a large diameter of the stylus tip with low weight. To enhance this effect, there is a distinction made between hemispherical and hollow hemispherical styli. Hollow hemispheres are produced using a complex manufacturing process in order to achieve maximum weight savings.

### M5, Hemisphere styli, ceramic

Hemisphere styli for applications that require a large diameter and a low weight. M5 thread for VAST active scanning sensors.

Connection Type: M5  
 Shaft Material: Tung. Carb.  
 Stylus Tip Geometry: Hemisphere  
 Stylus Tip Material: Ceramic  
 Ø Body (DG): 11

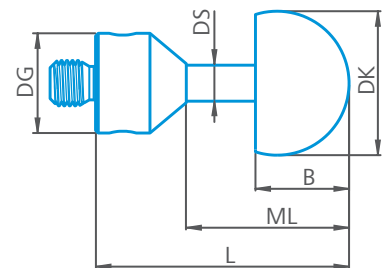

Article-No.	DK	L	ML	DS	B
626115-5000-871	13.50	53.00	40.00	6.00	7.50
626115-5000-842	23.00	70.00	57.00	6.00	13.50

### M5, Hollow-hemisphere styli, ceramic

Hollow hemisphere styli for applications that require a large diameter and a lowest weight. M5 thread for VAST active scanning sensors.

Connection Type: M5  
 Shaft Material: Steel  
 Stylus Tip Geometry: Hollow-Hemisphere  
 Stylus Tip Material: Ceramic  
 Ø Body (DG): 11

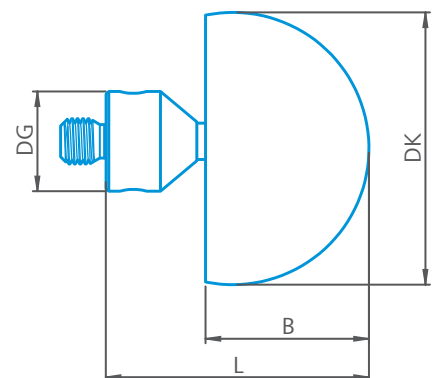

Article-No.	DK	L	B
626105-1696-020	16.00	20.00	10.00
626105-2296-020	22.00	20.00	14.50
626105-2296-025	22.00	23.00	14.50
626105-3096-025	30.00	25.00	18.00
626105-3696-026	36.00	26.00	21.00
626105-5000-032	50.00	32.00	27.00

# Cone shaft styli

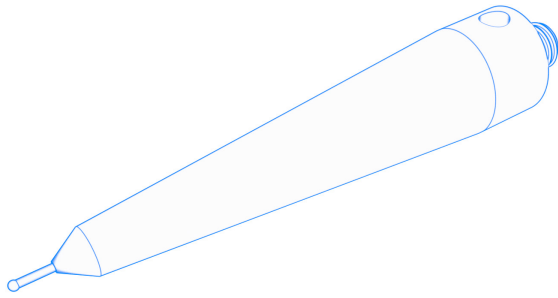

Cone shaft styli have an enlarged adapter that tapers only just before the stylus tip. This results in significantly better stiffness values for the entire stylus. Conversely, the usable length is reduced to the actual measuring length, since the conical contour subsequently provides a disturbing contour.

## M5, Cone shaft styli, ruby sphere, tungsten carbide shaft

Cone shaft styli for significantly better stiffness but reduced measuring length. M5 thread for VAST active scanning sensors.

Connection Type: M5  
 Shaft Material: Tung. Carb.  
 Stylus Tip Geometry: Sphere  
 Stylus Tip Material: Ruby  
 Ø Body (DG): 11

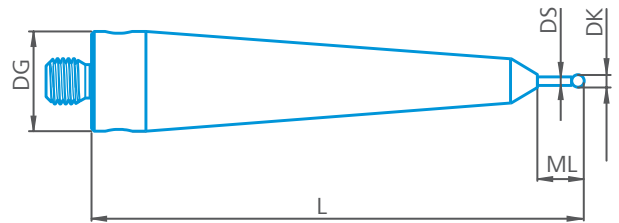

Article-No.	DK	L	ML	DS
602030-9019-000	1.00	55.00	4.00	0.80
602030-9020-000	1.50	55.00	5.00	1.00
626115-0150-070	1.50	70.00	20.00	1.00
602030-9021-000	2.00	55.00	5.00	1.50
626115-0201-055	2.00	55.00	10.00	1.50
602030-9022-000	2.50	55.00	5.00	2.00
602030-9023-000	3.50	55.00	10.00	2.50

## Long threaded styli

Long threaded styli enable the assembly of discs and star styli with groove and clamping disc. The remaining dimensions of the styli are identical to the short-thread version.

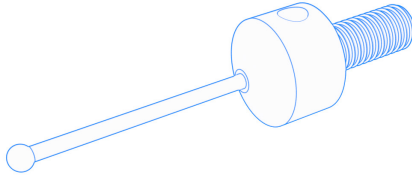

### M5, long threaded styli straight, ruby sphere, tungsten carbide shaft

Long threaded styli enable the assembly of discs and star elements with groove and clamping disc. M5 thread for VAST active scanning sensors.

Connection Type: M5x12,5  
 Shaft Material: Tung. Carb.  
 Stylus Tip Geometry: Sphere  
 Stylus Tip Material: Ruby  
 Ø Body (DG): 11

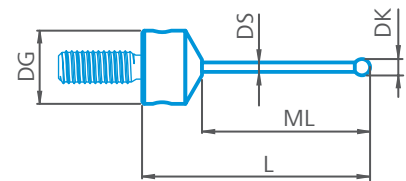

Article-No.	DK	L	ML	DS
626115-0140-032	1.35	32.00	23.00	1.00
600342-8200-000	1.35	32.85	23.85	1.00
600342-8201-000	1.50	33.00	24.00	1.00
600342-8202-000	2.00	33.50	24.50	1.50
600342-8203-000	2.50	34.00	25.00	1.50
626115-0305-080	3.00	80.00	71.00	2.00

### M5, long threaded styli stepped, ruby sphere, tungsten carbide shaft

Long threaded styli enable the assembly of discs and star elements with groove and clamping disc. M5 thread for VAST active scanning sensors.

Connection Type: M5x12,5  
 Shaft Material: Tung. Carb.  
 Stylus Tip Geometry: Sphere  
 Stylus Tip Material: Ruby  
 Ø Body (DG): 11

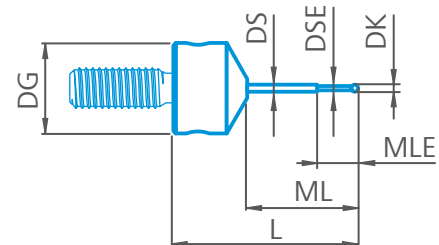

Article-No.	DK	L	ML	DS	MLE	DSE
600342-8250-000	0.30	21.80	12.80	1.00	2.30	0.20
600342-8251-000	0.50	22.00	13.00	1.00	2.50	0.30
600342-8252-000	0.60	22.10	13.10	1.00	4.60	0.40
600342-8253-000	0.80	22.30	13.30	1.00	4.80	0.60
600342-8254-000	1.00	22.50	13.50	1.00	5.00	0.80

# High precision



High precision styli are used in special measuring tasks, where low measuring uncertainties and stable results are needed. They are used for special applications and with high-end machines. High precision styli are delivered with a certificate.

## M5, Styli straight, sphere diameter tolerance $\pm 0,001$ , tungsten carbide shaft

High precision styli with tight diameter tolerances are used in special measuring tasks like self-centering scanning of gothic profiles. M5 thread for VAST active scanning sensors.

Connection Type: M5  
 Shaft Material: Tung. Carb.  
 Stylus Tip Geometry: Sphere  
 Stylus Tip Material: Ceramic  
 Ø Body (DG): 11

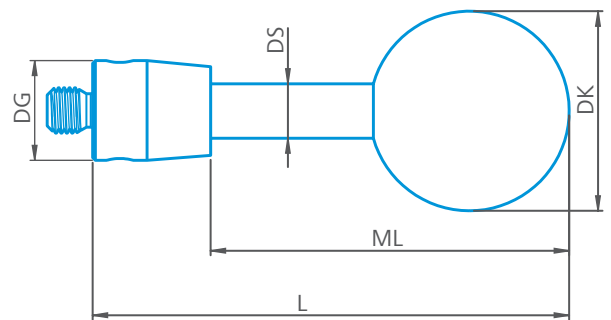

Article-No.	DK	L	ML	DS
626115-0790-133	7.94	133.00	120.00	3.00
626115-0791-150	7.94	150.00	137.00	5.00
626115-1100-063	11.00	63.00	50.00	3.00
626115-1100-083	11.00	83.00	70.00	3.00
626115-1190-073	11.91	73.00	60.00	3.00
626115-1340-093	13.49	93.00	80.00	5.00
626115-1401-083	14.00	83.00	70.00	6.00
626115-1421-083	14.29	83.00	70.00	6.00
626115-1460-083	14.60	83.00	70.00	6.00
626115-1480-083	14.80	83.00	70.00	6.00
626115-1500-083	15.08	83.00	70.00	6.00
626115-1560-083	15.60	83.00	70.00	6.00
626115-1581-083	15.88	83.00	70.00	6.00
626115-1600-093	16.00	93.00	80.00	6.00
626115-1611-070	16.10	70.00	57.00	6.00
626115-1610-083	16.10	83.00	70.00	6.00
626115-1640-083	16.40	83.00	70.00	6.00
626115-1662-083	16.67	83.00	70.00	6.00
626115-1680-083	16.90	83.00	70.00	6.00
626115-1701-083	17.00	83.00	70.00	6.00
626115-1721-083	17.20	83.00	70.00	6.00
626115-1741-083	17.46	83.00	70.00	6.00
626115-1741-100	17.46	100.00	87.00	6.00
626115-1762-070	17.69	70.00	57.00	6.00



Article-No.	DK	L	ML	DS
626115-1760-083	17.69	83.00	70.00	6.00
626115-1760-093	17.69	93.00	80.00	6.00
626115-1803-083	18.00	83.00	70.00	6.00
626115-1820-083	18.26	83.00	70.00	6.00
626115-1871-083	18.70	83.00	70.00	6.00
626115-1900-083	19.05	83.00	70.00	6.00
626115-1952-083	19.50	83.00	70.00	6.00
626115-1951-083	19.55	83.00	70.00	6.00
626115-1981-083	19.80	83.00	70.00	6.00
626115-1980-083	19.84	83.00	70.00	6.00
626115-1982-083	19.88	83.00	70.00	6.00
626115-2000-073	20.00	73.00	63.00	6.00
626115-2000-083	20.00	83.00	70.00	6.00
626115-2000-103	20.00	103.00	90.00	6.00
626115-2001-083	20.05	83.00	70.00	6.00
626115-2060-083	20.64	83.00	70.00	6.00
626115-2100-083	21.00	83.00	70.00	6.00
626115-2101-083	21.15	83.00	70.00	6.00
626115-2140-083	21.43	83.00	70.00	6.00
626115-2200-083	21.95	83.00	70.00	6.00
626115-2221-083	22.23	83.00	70.00	6.00
626115-2301-083	23.00	83.00	70.00	6.00
626115-2302-083	23.02	83.00	70.00	6.00
626115-2380-083	23.81	83.00	70.00	6.00
626115-2400-083	24.00	83.00	70.00	6.00
626115-2460-083	24.61	83.00	70.00	6.00

### M5, Styli straight, diamond coated sphere roundness <70nm, tungsten carbide shaft

High precision styli with a precise roundness are used in special measuring tasks like form measurement without a rotary table. M5 thread for VAST active scanning sensors.

Connection Type: M5  
 Shaft Material: Tung. Carb.  
 Stylus Tip Geometry: Sphere-Segment  
 Stylus Tip Material: Diamond Coated  
 Ø Body (DG): 11

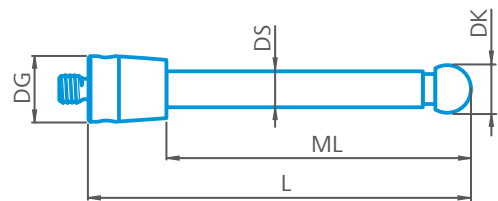

Article-No.	DK	L	ML	DS
626115-0139-034	2.00	33.50	20.50	1.50
626115-0339-034	2.00	34.00	24.00	1.50
626115-0139-037	2.00	37.00	24.00	1.50
626115-0239-050	2.00	50.00	40.00	1.50
626115-0039-053	2.00	53.00	40.00	1.50
626115-0239-034	3.00	33.50	23.50	2.00
626115-0039-034	3.00	33.50	20.50	2.00
626115-0039-037	3.00	36.50	23.50	2.00
626115-0039-050	3.00	50.00	37.00	2.00





<b>Article-No.</b>	<b>DK</b>	<b>L</b>	<b>ML</b>	<b>DS</b>
626115-0039-058	3.00	58.00	45.00	2.00
626115-0039-073	3.00	73.00	60.00	2.00
626115-0139-075	4.00	75.00	65.00	3.00
626115-0139-050	5.00	50.00	37.00	3.50
626115-0039-075	5.00	75.00	62.00	3.50
626115-0139-055	6.00	55.00	45.00	3.50
626115-0239-058	6.00	58.00	45.00	3.50
626115-0039-064	8.00	63.50	50.50	6.00

## Special diameter

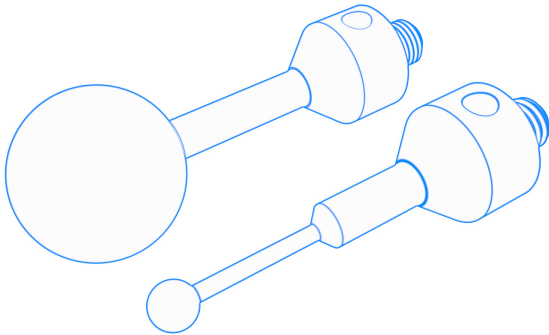

Styli with standard diameters are manufactured in batches with a large quantity of spheres and can thus be manufactured cost-effectively. Styli with special diameters are custom-made devices that can only be produced in special manufacturing processes. Therefore, they can only be offered at higher costs or in larger acceptance quantities. The most common spherical material in this category is tungsten carbide, which means that limitations in the spherical shape must be taken into account, while ceramic materials are used primarily for inch sizes.

### M5, Styli straight, tungsten carbide sphere, tungsten carbide shaft

Custom made styli with a special diameter for very special measuring tasks. M5 thread for VAST active scanning sensors.

Connection Type: M5  
 Shaft Material: Tung. Carb.  
 Stylus Tip Geometry: Sphere  
 Stylus Tip Material: Tung. Carb.  
 Ø Body (DG): 11

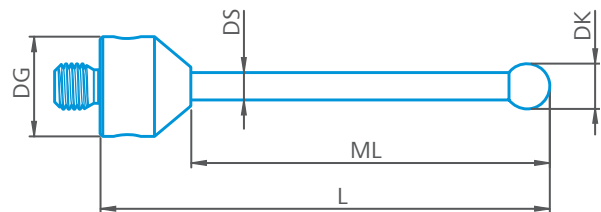

Article-No.	DK	L	ML	DS
626115-0101-022	1.00	22.00	12.50	0.70
626115-0105-030	1.02	30.00	20.00	0.80
626115-0121-032	1.27	32.00	22.00	0.80
626115-0130-035	1.27	35.00	25.00	0.80
626115-0120-035	1.27	35.00	25.00	1.00
626115-0145-024	1.45	23.50	13.50	1.00
626115-0152-034	1.50	33.50	22.50	1.30
626115-0156-020	1.55	20.00	10.00	1.00
626115-0150-026	1.57	26.00	16.00	1.00
626115-0160-028	1.59	28.00	18.00	1.00
626115-0170-040	1.73	40.00	30.00	1.00
626115-0171-100	1.75	100.00	90.00	1.00
626115-0182-030	1.80	30.00	20.00	1.50
626115-0180-026	1.82	26.00	16.00	1.00
626115-0200-022	2.00	22.50	13.50	1.50
626115-0204-045	2.03	45.00	35.00	1.00
626115-0205-100	2.03	100.00	90.00	1.50
626115-0207-034	2.05	33.50	23.50	1.50
626115-0206-034	2.06	33.50	23.50	1.50
626115-0212-040	2.12	40.00	30.00	1.50
626115-0210-034	2.15	33.50	23.50	1.50
626115-0220-030	2.20	30.00	19.00	1.50
626115-0221-040	2.20	40.00	30.00	1.50
626115-0222-040	2.24	40.00	30.00	1.00
626115-0221-050	2.24	50.00	40.00	1.00



Article-No.	DK	L	ML	DS
626115-0230-060	2.36	60.00	50.00	1.50
626115-0241-020	2.38	20.00	10.00	1.50
626115-0243-040	2.44	40.00	30.00	1.50
626115-0270-040	2.70	40.00	30.00	2.00
626115-0271-020	2.74	20.00	10.00	1.50
626115-0270-025	2.75	25.00	15.00	2.00
626115-0280-034	2.75	33.50	22.50	1.50
626115-0280-060	2.75	60.00	50.00	1.50
626115-0300-034	3.00	33.50	23.50	2.00
626115-0301-050	3.00	50.00	40.00	2.00
626115-0311-100	3.00	100.00	90.00	2.00
626115-0320-020	3.18	20.00	10.00	1.00
626115-0321-034	3.18	33.50	23.50	2.00
626115-0320-025	3.20	25.00	15.00	2.00
626115-0321-050	3.20	50.00	40.00	2.00
626115-0320-066	3.20	66.00	54.00	2.00
626115-0330-095	3.25	95.00	85.00	2.00
626115-0331-050	3.30	50.00	40.00	2.00
626115-0340-035	3.40	35.00	25.00	2.00
626115-0340-058	3.40	58.00	48.00	2.00
626115-0363-040	3.63	40.00	30.00	2.00
626115-0360-026	3.66	26.00	16.00	1.00
626115-0380-030	3.75	30.00	19.00	2.00
626115-0380-060	3.75	60.00	50.00	3.00
626115-0390-034	3.90	33.50	23.50	2.00
626115-0390-020	3.97	20.00	10.00	2.00
626115-0393-030	4.00	30.00	20.00	2.00
626115-0408-030	4.04	30.00	20.00	2.00
626115-0400-021	4.09	20.50	10.50	2.00
626115-0430-060	4.25	60.00	48.00	3.50
626115-0400-067	4.40	67.00	57.00	3.00
626115-0470-053	4.70	53.00	43.00	3.50
626115-0473-030	4.75	30.00	20.00	2.00
626115-0480-020	4.76	20.00	10.00	2.00
626115-0481-020	4.76	20.00	10.00	3.50
626115-0480-025	4.76	25.00	15.00	2.00
626115-0480-034	4.76	33.50	23.50	2.00
626115-0480-030	4.80	30.00	20.00	1.50
626115-0480-095	4.84	95.00	85.00	3.50
626115-0500-053	5.00	53.00	40.00	3.50
626115-0501-073	5.00	73.00	63.00	3.50
000000-1073-344	5.00	105.00	95.00	3.50
626115-0502-054	5.08	54.00	44.00	3.50
626115-0520-040	5.20	40.00	30.00	2.50
626115-0520-135	5.20	135.00	125.00	2.50
626115-0551-020	5.55	20.00	10.00	2.50
626115-0555-018	5.56	18.00	8.00	2.00
626115-0555-025	5.56	25.00	15.00	2.00
626115-0551-040	5.56	40.00	30.00	2.50
626115-0560-090	5.60	90.00	80.00	4.00
626115-0560-054	5.65	54.00	44.00	3.50
626115-0620-060	6.25	60.00	50.00	4.00
626115-0680-030	6.80	30.00	20.00	3.00
626115-0710-080	7.14	80.00	70.00	3.50



Article-No.	DK	L	ML	DS
626115-0710-085	7.14	85.00	75.00	2.00
626115-0730-030	7.30	30.00	20.00	3.50
626115-0791-040	7.90	40.00	30.00	2.50
612030-9649-000	8.00	63.50	50.50	6.00
626115-0950-092	9.53	92.00	79.00	6.00
626115-1030-070	10.32	70.00	57.00	5.00
626115-1190-070	11.91	70.00	57.00	5.00
626115-1250-093	12.50	93.00	80.00	6.00
626115-1272-040	12.70	40.00	27.00	5.00
626115-1270-100	12.70	100.00	87.00	5.00
626115-1340-100	13.49	100.00	87.00	5.00
626115-1341-100	13.49	100.00	87.00	5.00
626115-1350-075	13.50	75.00	60.00	6.00
626115-1360-030	13.68	30.00	17.00	4.00
626115-1390-093	13.90	93.00	80.00	6.00
626115-1430-080	14.29	80.00	66.00	6.00
626115-1430-100	14.29	100.00	86.00	6.00
626115-1460-054	14.68	54.00	41.00	5.00
626115-1470-060	14.70	60.00	47.00	6.00
626115-1470-063	14.70	63.00	50.00	5.00
626115-1471-063	14.78	63.00	50.00	5.00
626115-1480-054	14.80	54.00	41.00	5.00
626115-1510-080	15.08	80.00	67.00	6.00
626115-1510-100	15.08	100.00	87.00	6.00
626115-1530-050	15.30	60.00	47.00	6.00
626115-1530-063	15.30	63.00	50.00	5.00
626115-1560-054	15.60	54.00	41.00	5.00
626115-1590-100	15.88	100.00	86.00	6.00
626115-1600-063	16.00	63.00	50.00	5.00
626115-1600-075	16.00	75.00	62.00	6.00
626115-1630-077	16.37	77.00	64.00	6.00
626115-1660-040	16.67	40.00	27.00	5.00
626115-1670-100	16.67	100.00	87.00	6.00
626115-1673-100	16.67	100.00	90.00	4.50
626115-1740-040	17.46	40.00	27.00	5.00
626115-1750-065	17.46	65.00	52.00	6.00
626115-1750-090	17.46	90.00	77.00	6.00
626115-1750-100	17.46	100.00	87.00	6.00
626115-1780-075	17.80	75.00	60.00	6.00
626115-1801-054	18.00	54.00	41.00	5.00
626115-1820-060	18.26	60.00	47.00	6.00
626115-1830-068	18.26	68.00	55.00	6.00
626115-1826-100	18.26	100.00	87.00	6.00
626115-1850-070	18.50	70.00	57.00	5.00
626115-1860-100	18.55	100.00	87.00	6.00
626115-1880-054	18.80	54.00	41.00	5.00
626115-1900-060	19.05	60.00	47.00	6.00
626115-1910-100	19.05	100.00	87.00	6.00
626115-1940-040	19.45	40.00	27.00	6.00
626115-1940-060	19.45	60.00	47.00	6.00
626115-1960-054	19.60	54.00	41.00	5.00



Article-No.	DK	L	ML	DS
626115-1980-115	19.75	115.00	102.00	6.00
626115-1981-080	19.84	80.00	67.00	6.00
626115-1980-100	19.84	100.00	87.00	6.00
626115-1980-110	19.84	110.00	100.00	4.00
626115-2000-063	20.60	63.00	50.00	5.00
626115-2061-065	20.64	65.00	52.00	6.00
626115-2063-080	20.64	80.00	67.00	6.00
626115-2001-063	20.70	63.00	50.00	5.00
626115-2140-063	21.43	63.00	50.00	5.00
626115-2141-080	21.43	80.00	67.00	6.00
626115-2140-100	21.43	100.00	87.00	6.00
626115-2151-034	21.50	34.00	21.50	11.00
626115-2200-115	22.05	115.00	102.00	6.00
626115-2300-080	23.02	80.00	67.00	6.00
626115-2360-036	23.68	36.00	23.68	11.00
626115-2380-100	23.81	100.00	87.00	6.00
626115-2600-082	26.00	82.00	59.00	6.00
626115-2610-090	26.19	90.00	77.00	6.00
626115-2600-100	26.19	100.00	87.00	6.00
626115-2690-080	26.99	80.00	67.00	5.00

### M5, Styli stepped, ceramic sphere, tungsten carbide shaft

Custom made styli with a special diameter for very special measuring tasks. M5 thread for VAST active scanning sensors.

Connection Type: M5  
 Shaft Material: Tung. Carb.  
 Stylus Tip Geometry: Sphere  
 Stylus Tip Material: Ceramic  
 Ø Body (DG): 11

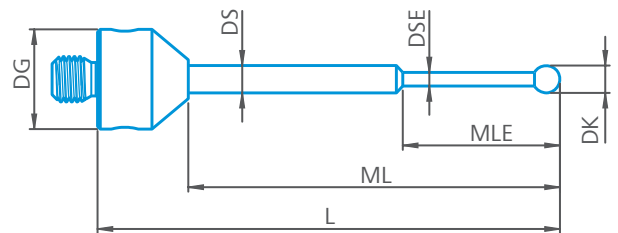

Article-No.	DK	L	ML	DS	MLE	DSE
626115-1200-135	12.00	135.00	125.00	6.00	65.00	3.00
626115-1400-053	14.00	53.00	43.00	4.00	22.00	3.00

### M5, Styli straight, ceramic sphere, tungsten carbide shaft

Custom made styli with a special diameter for very special measuring tasks. M5 thread for VAST active scanning sensors.

Connection Type: M5  
 Shaft Material: Tung. Carb.  
 Stylus Tip Geometry: Sphere  
 Stylus Tip Material: Ceramic  
 Ø Body (DG): 11

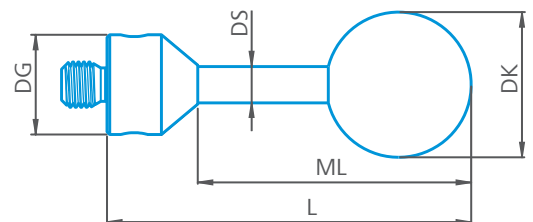

Article-No.	DK	L	ML	DS
626115-0800-120	8.00	120.00	105.00	6.00
626115-1002-118	10.00	118.00	105.00	6.00



Article-No.	DK	L	ML	DS
626115-1102-060	11.00	60.00	50.00	3.00
626115-1100-070	11.00	70.00	57.00	6.00
626115-1111-050	11.11	50.00	37.00	6.00
626115-1190-060	11.91	60.00	50.00	3.50
626115-1190-085	11.91	85.00	72.00	5.00
626115-1200-025	12.00	25.00	12.00	5.00
626115-1204-065	12.00	65.00	52.00	6.00
626115-1200-120	12.00	120.00	106.00	6.00
626115-1200-160	12.00	160.00	145.00	6.00
626115-1270-070	12.70	70.00	57.00	5.00
626115-1302-065	13.00	65.00	52.00	5.00
626115-1300-075	13.00	75.00	65.00	4.00
626115-1300-120	13.00	120.00	107.00	6.00
626115-1300-122	13.00	122.00	109.00	8.00
626115-1300-283	13.00	283.00	270.00	10.00
626115-1351-075	13.49	75.00	62.00	5.00
626115-1400-024	14.00	24.00	14.00	5.00
626115-1400-028	14.00	28.00	18.00	5.00
000000-1212-631	14.00	50.00	36.50	6.00
626115-1400-054	14.00	54.00	40.00	6.00
626115-1402-065	14.00	65.00	52.00	6.00
626115-1400-066	14.00	65.50	52.50	6.00
626115-1402-080	14.00	80.00	67.00	5.00
626115-1401-120	14.00	120.00	110.00	3.00
626115-1460-070	14.60	70.00	57.00	6.00
626115-1462-080	14.60	80.00	67.00	5.00
626115-1460-100	14.60	100.00	87.00	6.00
626115-1470-075	14.70	75.00	62.00	6.00
626115-1482-080	14.84	80.00	67.00	6.00
626115-1490-080	14.94	80.00	67.00	6.00
626115-1500-030	15.00	30.00	16.00	5.00
626115-1500-060	15.00	60.00	46.00	5.00
626115-1500-075	15.00	75.00	61.00	6.00
626115-1500-085	15.00	85.00	70.00	6.00
626115-1503-085	15.00	85.00	72.00	5.00
000000-1050-765	15.00	100.00	87.00	6.00
626115-1501-100	15.00	100.00	87.00	8.00
626115-1500-115	15.00	115.00	100.00	6.00
626115-1502-115	15.00	115.00	102.00	8.00
626115-1501-118	15.00	118.00	105.00	6.00
626115-1500-120	15.00	120.00	106.00	6.00
626115-1500-143	15.00	143.00	133.00	4.00
626115-1500-150	15.00	150.00	140.00	3.50
626115-1501-160	15.00	160.00	150.00	4.00
626115-1500-215	15.00	215.00	200.00	6.00
626115-1504-060	15.08	60.00	47.00	5.00
626115-1511-080	15.08	80.00	67.00	6.00
626115-1510-085	15.08	85.00	72.00	6.00
626115-1503-120	15.08	120.00	107.00	6.00
626115-1530-075	15.30	75.00	62.00	6.00
626115-1580-065	15.88	65.00	52.00	5.00



Article-No.	DK	L	ML	DS
626115-1591-080	15.88	80.00	67.00	6.00
626115-1580-085	15.88	85.00	72.00	6.00
626115-1600-028	16.00	28.00	28.00	5.00
612030-9609-000	16.00	28.00	16.00	5.00
626115-1600-050	16.00	50.00	40.00	5.00
626115-5000-850	16.00	50.00	40.00	5.00
626115-1600-065	16.00	65.00	51.00	5.00
626115-1600-076	16.00	76.00	62.00	6.00
626115-1600-080	16.00	80.00	67.00	6.00
626115-1600-119	16.00	119.00	105.00	6.00
626115-1600-120	16.00	120.00	107.00	6.00
626115-1662-070	16.67	70.00	57.00	6.00
626115-1670-085	16.67	85.00	72.00	6.00
626115-1671-100	16.67	100.00	87.00	6.00
626115-1681-070	16.90	70.00	57.00	6.00
626115-1700-057	17.00	57.00	44.00	6.00
626115-1700-066	17.00	65.50	52.50	6.00
626115-1700-077	17.00	77.00	63.00	6.00
626115-1700-095	17.00	95.00	81.00	6.00
626115-1700-103	17.00	103.00	90.00	8.00
626115-1751-060	17.46	60.00	47.00	6.00
626115-1740-070	17.46	70.00	57.00	6.00
626115-1750-081	17.46	81.00	68.00	6.00
626115-1800-054	18.00	54.00	40.00	5.00
626115-1800-100	18.00	100.00	85.00	6.00
626115-1801-100	18.00	100.00	87.00	5.00
626115-1801-120	18.00	120.00	107.00	5.00
626115-1800-200	18.00	200.00	190.00	4.50
626115-1831-066	18.26	66.00	53.00	6.00
626115-1830-100	18.26	100.00	87.00	6.00
626115-1900-066	19.00	65.50	52.50	6.00
626115-1901-050	19.05	50.00	37.00	5.00
626115-1910-067	19.05	67.00	54.00	6.00
626115-1900-080	19.05	80.00	66.00	8.00
626115-1950-080	19.50	80.00	67.00	5.00
626115-1980-050	19.84	50.00	37.00	5.00
626115-1980-080	19.84	80.00	67.00	6.00
626115-1980-085	19.84	85.00	72.00	6.00
626115-2000-033	20.00	33.00	33.00	5.00
626115-2003-050	20.00	50.00	37.00	6.00
626115-2000-060	20.00	60.00	45.00	6.00
626115-2000-075	20.00	75.00	62.00	5.00
626115-2000-080	20.00	80.00	66.00	6.00
626115-2000-090	20.00	90.00	77.00	4.00
000000-1198-321	20.00	100.00	87.00	6.00
626115-2000-100	20.00	100.00	87.00	5.00
626115-2001-120	20.00	120.00	105.00	6.00
626115-2060-065	20.64	65.00	52.00	6.00
626115-2060-110	20.64	110.00	97.00	8.00
626115-2100-085	21.00	85.00	72.00	6.00
626115-2101-085	21.43	85.00	72.00	6.00
626115-2200-050	22.00	50.00	37.00	6.00
626115-2200-060	22.00	60.00	47.00	6.00
626115-2220-060	22.23	60.00	47.00	6.00



<b>Article-No.</b>	<b>DK</b>	<b>L</b>	<b>ML</b>	<b>DS</b>
626115-2220-085	22.23	85.00	72.00	6.00
626115-2250-050	22.50	50.00	40.00	5.00
626115-2300-053	23.00	53.00	40.00	8.00
626115-2380-070	23.81	70.00	57.00	6.00
626115-2400-060	24.00	60.00	50.00	6.00
626115-2400-080	24.00	80.00	67.00	6.00
612030-9475-000	25.00	38.00	25.00	5.00
626115-2500-120	25.00	120.00	106.00	6.00
626115-2500-225	25.00	225.00	210.00	6.00
626115-2540-035	25.40	35.00	26.00	5.00
626115-2550-040	25.50	40.00	27.00	5.00
626115-2601-039	26.00	39.00	26.00	6.00
626115-2600-058	26.00	58.00	45.00	8.00
626115-2600-065	26.00	65.00	52.00	8.00
626115-2600-085	26.19	85.00	72.00	6.00
626115-2691-080	26.99	80.00	67.00	5.00
626115-2800-042	28.00	42.00	32.00	6.00
626115-2800-075	28.00	75.00	61.00	6.00
626115-3000-043	30.00	43.00	30.00	5.00
626115-3000-075	30.00	75.00	63.00	5.00
626115-3000-120	30.00	120.00	107.00	8.00
626115-3170-050	31.75	50.00	37.00	6.00
626115-4500-060	45.00	60.00	50.00	6.00
626115-4500-120	45.00	120.00	106.00	6.00



## M5, Styli stepped, tungsten carbide sphere, tungsten carbide shaft

Custom made styli with a special diameter for very special measuring tasks. M5 thread for VAST active scanning sensors.

Connection Type: M5  
 Shaft Material: Tung. Carb.  
 Stylus Tip Geometry: Sphere  
 Stylus Tip Material: Tung. Carb.  
 Ø Body (DG): 11

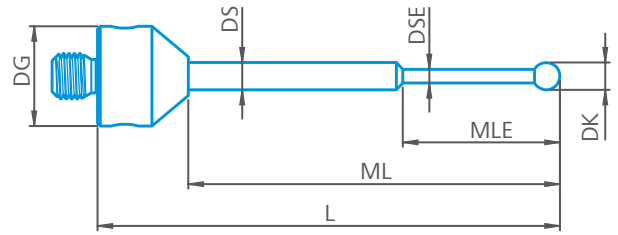

Article-No.	DK	L	ML	DS	MLE	DSE
626115-0021-018	0.20	18.00	8.00	0.60	1.35	0.17
626115-0030-020	0.30	20.00	10.00	1.00	2.30	0.20
626115-0030-040	0.30	40.00	30.00	2.00	3.00	0.20
626115-0060-023	0.62	23.00	13.00	1.00	10.00	0.50
626115-0109-030	1.02	30.00	20.00	1.00	5.00	0.70
626115-0141-044	1.42	44.00	34.00	4.00	19.00	1.00
626115-0206-044	2.03	44.00	34.00	4.00	19.00	1.50
626115-0212-058	2.03	58.00	48.00	4.00	33.00	1.50
626115-2801-082	28.00	82.00	59.00	6.00	44.00	4.00

## M3 XXT

Styli with M3 thread and an enlarged 5 mm base suitable for the ZEISS VAST XXT scanning sensors

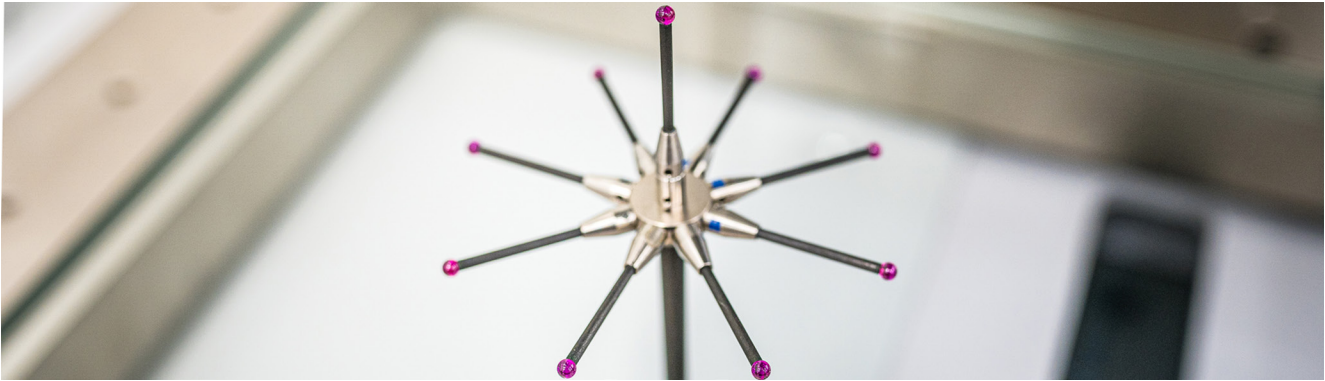

VAST XXT Styli with M3 thread were developed especially for ZEISS VAST XXT measuring probes. ZEISS M3 XXT styli have a much higher rigidity than conventional M3 styli. This stiffness is achieved through a 1 mm larger diameter of the XXT adapter with a titanium alloy base body. This alloy also makes the adapters significantly lighter than steel, non-magnetic and corrosion resistant. In the M3 XXT range, different stylus elements (sphere, ball cylinder etc.) made of different materials and different shaft designs (shape, material) are available.

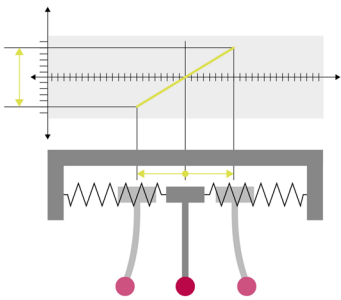

### Passive scanning VAST XXT

Passive “mechanical” springs are deflected and achieve a constantly changing, high probing force which is proportional to the deflection. The resulting stylus bending is not easy to correct. Probing in a limited range requires repeated readjustment of the main axis, which reduces the scanning speed and reduces the accuracy.

### ZEISS styli with a carbon fibre shaft

Due to the weight restrictions of the VAST XXT probes, it is necessary for all components of the stylus system to have the lowest possible weight. In the case of the M3 XXT stylus, this can be realized by styli with carbon fiber shaft. Carbon fiber shafts represent an optimum combination of stiffness, weight, and thermal linear expansion. This makes them particularly suitable for long styli and demanding measurement tasks, such as in production with constantly changing ambient temperatures. They are also ideal for magnetic applications.



# Reference styli

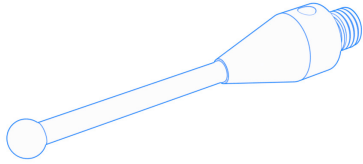

ZEISS reference styli are used to determine the position and geometry of the qualification test piece, usually a sphere. The software thus recognizes the ACTUAL data of the qualification test piece, which can then be compared with the calibrated NOMINAL data in order to detect machine errors. Afterwards, all following styli installed in stylus systems can be qualified in relation to them. Master styli are defined and labeled according to stability and accuracy in a readout procedure. Optimum results can be achieved during qualification. In the M3 XXT system there are 2 different kinds of reference styli. Standard with titanium adapter and for quick set-up with a knurled plastic adapter.

## M3 XXT, Reference styli straight, carbon fibre shaft

Reference Styli are used to determine the position of calibration reference spheres. M3 thread for ZEISS VAST XXT sensors.

Connection Type: M3 XXT  
 Shaft Material: Carbon Fiber  
 Stylus Tip Geometry: Sphere  
 Stylus Tip Material: Ruby  
 Ø Body (DG): 5

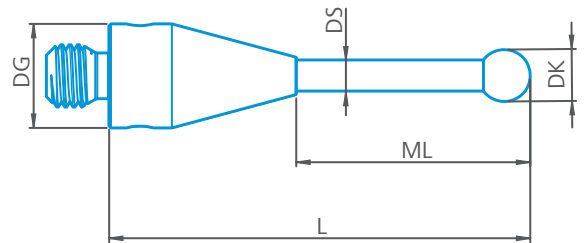

Article-No.	DK	L	ML	DS
626103-0501-030	5.00	30.00	21.00	3.50
626103-0501-050	5.00	50.00	41.00	3.50

## M3 XXT, Reference styli straight, carbon fibre shaft, knurled plastic adapter

Reference Styli to determine the exact position of the calibrated reference sphere. Knurled plastic adapter for assembly without tools. M3 thread for ZEISS VAST XXT sensors.

Connection Type: M3 XXT  
 Shaft Material: Carbon Fiber  
 Stylus Tip Geometry: Sphere  
 Stylus Tip Material: Ruby  
 Ø Body (DG): 5

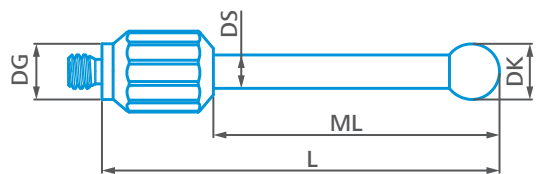

Article-No.	DK	L	ML	DS
626103-0527-030	5.00	30.00	20.00	3.00
626103-0527-050	5.00	50.00	40.00	3.00

## Standard styli

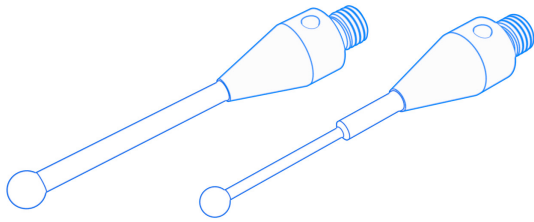

Spherical styli have the largest field of application because they have the same probing behavior in every direction. They are therefore suitable for all common measuring tasks such as measuring bores and surfaces. The larger the stylus sphere size, the larger the mechanical filter. This means that the profile of your workpiece is smoothed, which is often required in form measurement. The deviation from the ideal sphere shape is usually shown in Grade. ZEISS stylus tips come standard with Grade 5, but can also be offered with highly accurate roundness or diameters with a certificate for special requirements. Styli with a straight shaft are the most simple designed styli. The full shaft length can be used as measuring length. Stepped shaft has the advantage of a greater shaft thickness, which is reduced towards the measuring tip. This stepped shaft increases the stability of the shaft while maintaining the same length (depending on the sphere diameter). At the same time, however, the usable measuring length is reduced.

### M3 XXT, Styli straight, ruby sphere, tungsten carbide shaft

Standard Styli suitable for all common measuring tasks. M3 thread for ZEISS VAST XXT sensors.

Connection Type: M3 XXT  
 Shaft Material: Tung. Carb.  
 Stylus Tip Geometry: Sphere  
 Stylus Tip Material: Ruby  
 Ø Body (DG): 5

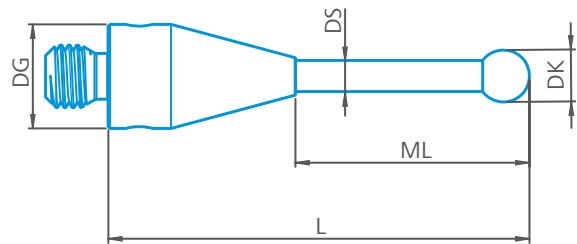

Article-No.	DK	L	ML	DS
626113-0060-012	0.60	12.00	3.00	0.50
626113-0061-019	0.60	19.00	10.00	0.40
626113-0065-020	0.60	20.00	11.00	0.40
626113-0070-021	0.70	21.00	12.00	0.50
626113-0070-022	0.70	22.00	13.00	0.50
626113-0080-010	0.80	10.00	1.00	0.60
626113-0080-014	0.80	14.00	5.00	0.60
626113-0081-017	0.80	17.00	8.00	0.60
626113-0080-018	0.80	18.00	9.00	0.45
626113-0080-021	0.80	21.00	12.00	0.60
626113-0082-025	0.80	25.00	16.00	0.60
626113-0080-029	0.80	29.00	20.00	0.60
626113-0083-035	0.80	35.00	26.00	0.60
626113-0090-016	0.90	16.00	7.00	0.60
626113-0100-010	1.00	10.00	1.00	0.80
626113-0101-013	1.00	12.50	3.50	0.70
626113-0102-013	1.00	13.00	4.00	0.70
626113-0100-014	1.00	14.00	5.00	0.80
626113-0101-015	1.00	15.00	6.00	0.80
626113-0100-017	1.00	17.00	8.00	0.80



Article-No.	DK	L	ML	DS
626113-0103-020	1.00	20.00	11.00	0.80
626113-0105-020	1.00	20.00	11.00	0.60
626113-0102-022	1.00	21.50	12.50	0.80
626113-0100-024	1.00	24.00	15.00	0.50
626113-0101-024	1.00	24.00	15.00	0.70
626113-0104-025	1.00	25.00	16.00	0.80
626113-0101-028	1.00	28.00	19.00	0.70
626113-0101-030	1.00	30.00	21.00	0.80
626113-0103-035	1.00	35.00	26.00	0.80
626113-0100-039	1.00	39.00	30.00	0.80
626113-0105-040	1.00	40.00	31.00	0.80
626113-0100-050	1.00	50.00	41.00	1.00
626113-0120-017	1.25	17.00	8.00	0.80
626113-0120-024	1.25	24.00	15.00	1.00
626113-0130-021	1.30	21.00	12.00	1.00
626113-0130-043	1.30	43.00	34.00	1.00
626103-5754-013	1.35	13.00	4.00	1.00
626103-5754-014	1.35	14.00	5.00	1.00
626103-5754-015	1.35	15.00	6.00	1.00
626103-5754-016	1.35	16.00	7.00	1.00
626103-5754-017	1.35	17.00	8.00	1.00
626103-5754-018	1.35	18.00	9.00	1.00
626103-5754-019	1.35	19.00	10.00	1.00
626103-5754-020	1.35	20.00	11.00	1.00
626103-5754-021	1.35	21.00	12.00	1.00
626103-5754-022	1.35	22.00	13.00	1.00
626103-5754-023	1.35	23.00	14.00	1.00
626113-0141-024	1.35	24.00	15.00	1.00
626103-5754-025	1.35	25.00	16.00	1.00
626103-5754-026	1.35	26.00	17.00	1.00
626103-5754-027	1.35	27.00	18.00	1.00
626103-5754-028	1.35	28.00	19.00	1.00
626103-5754-029	1.35	29.00	20.00	1.00
626103-5754-030	1.35	30.00	21.00	1.00
626113-0141-030	1.35	30.00	21.00	1.00
626103-5754-031	1.35	31.00	22.00	1.00
626103-5754-032	1.35	32.00	23.00	1.00
626103-5754-033	1.35	33.00	24.00	1.00
626103-5754-034	1.35	34.00	25.00	1.00
626103-5754-035	1.35	35.00	26.00	1.00
626103-5754-036	1.35	36.00	27.00	1.00
626103-5754-037	1.35	37.00	28.00	1.00
626103-5754-038	1.35	38.00	29.00	1.00
626103-5754-039	1.35	39.00	30.00	1.00
626103-5754-040	1.35	40.00	31.00	1.00
626103-5754-041	1.35	41.00	32.00	1.00
626103-5754-042	1.35	42.00	33.00	1.00
626103-5754-043	1.35	43.00	34.00	1.00
626103-5754-044	1.35	44.00	35.00	1.00
626103-5754-045	1.35	45.00	36.00	1.00
626113-0140-019	1.40	19.00	10.00	1.00
626103-0144-013	1.50	13.00	4.00	1.00
626113-0150-014	1.50	14.00	5.00	1.00
626103-0144-015	1.50	15.00	6.00	1.00



Article-No.	DK	L	ML	DS
626103-0144-016	1.50	16.00	7.00	1.00
626113-0150-017	1.50	17.00	8.00	1.00
626103-0144-018	1.50	18.00	9.00	1.00
626103-0144-019	1.50	19.00	10.00	1.00
626113-0150-020	1.50	20.00	11.00	1.00
626113-0155-020	1.50	20.00	11.00	0.60
626103-0144-021	1.50	21.00	12.00	1.00
626103-0144-022	1.50	22.00	13.00	1.00
626103-0144-023	1.50	23.00	14.00	1.00
626103-0144-024	1.50	24.00	15.00	1.00
626113-0151-025	1.50	25.00	16.00	1.00
626103-0144-026	1.50	26.00	17.00	1.00
626103-0144-027	1.50	27.00	18.00	1.00
626103-0144-028	1.50	28.00	19.00	1.00
626103-0144-029	1.50	29.00	20.00	1.00
626113-0151-030	1.50	30.00	21.00	1.00
626103-0144-031	1.50	31.00	22.00	1.00
626103-0144-032	1.50	32.00	23.00	1.00
626103-0144-033	1.50	33.00	24.00	1.00
626103-0144-034	1.50	34.00	25.00	1.00
626113-0150-035	1.50	35.00	26.00	1.00
626103-0144-036	1.50	36.00	27.00	1.00
626103-0144-037	1.50	37.00	28.00	1.00
626103-0144-038	1.50	38.00	29.00	1.00
626103-0144-039	1.50	39.00	30.00	1.00
626113-0151-040	1.50	40.00	31.00	1.00
626103-0144-041	1.50	41.00	32.00	1.00
626103-0144-042	1.50	42.00	33.00	1.00
626103-0144-043	1.50	43.00	34.00	1.00
626103-0144-044	1.50	44.00	35.00	1.00
626103-0144-045	1.50	45.00	36.00	1.00
626103-0144-046	1.50	46.00	37.00	1.00
626103-0144-047	1.50	47.00	38.00	1.00
626103-0144-048	1.50	48.00	39.00	1.00
626103-0144-049	1.50	49.00	40.00	1.00
626113-0150-050	1.50	50.00	41.00	1.00
626103-0144-051	1.50	51.00	42.00	1.00
626103-0144-052	1.50	52.00	43.00	1.00
626113-0151-052	1.50	52.00	43.00	1.00
626103-0144-053	1.50	53.00	44.00	1.00
626103-0144-054	1.50	54.00	45.00	1.00
626103-0144-055	1.50	55.00	46.00	1.00
626103-0144-056	1.50	56.00	47.00	1.00
626103-0144-057	1.50	57.00	48.00	1.00
626103-0144-058	1.50	58.00	49.00	1.00
626113-0150-059	1.50	59.00	50.00	1.00
626103-0144-060	1.50	60.00	51.00	1.00
626113-0150-064	1.50	64.00	55.00	1.00
626113-0150-070	1.50	70.00	61.00	1.00
626113-0150-080	1.50	80.00	71.00	1.00
626113-0161-035	1.60	35.00	26.00	1.00



Article-No.	DK	L	ML	DS
626113-0170-020	1.70	20.00	11.00	1.00
626113-0180-030	1.75	30.00	21.00	1.00
626113-0180-035	1.75	34.50	25.50	1.00
626113-5000-043	1.75	35.00	26.00	1.50
626113-0170-040	1.75	40.00	31.00	1.00
626113-0170-066	1.75	66.00	57.00	1.00
626113-0170-100	1.75	100.00	91.00	1.50
626113-0180-020	1.80	20.00	10.00	1.50
626113-0182-030	1.80	30.00	21.00	1.50
626113-0180-080	1.80	80.00	71.00	1.50
626113-0180-100	1.80	100.00	91.00	1.50
626113-0190-020	1.90	20.00	11.00	1.00
626103-0244-013	2.00	13.00	4.00	1.00
626113-0200-014	2.00	14.00	5.00	1.00
626113-5000-080	2.00	14.00	5.00	1.00
626103-0244-015	2.00	15.00	6.00	1.00
626103-0244-016	2.00	16.00	7.00	1.00
626113-0200-017	2.00	17.00	8.00	1.00
626103-0244-018	2.00	18.00	9.00	1.00
626103-0244-019	2.00	19.00	10.00	1.00
626113-0200-020	2.00	20.00	11.00	1.00
626103-0244-021	2.00	21.00	12.00	1.00
626103-0244-022	2.00	22.00	13.00	1.00
626103-0244-023	2.00	23.00	14.00	1.00
626103-0244-024	2.00	24.00	15.00	1.00
626113-0200-024	2.00	24.00	15.00	2.00
626113-0200-025	2.00	25.00	16.00	1.00
626103-0244-026	2.00	26.00	17.00	1.00
626103-0244-027	2.00	27.00	18.00	1.00
626103-0244-028	2.00	28.00	19.00	1.00
626103-0244-029	2.00	29.00	20.00	1.00
626113-0200-030	2.00	30.00	21.00	1.00
626103-0244-031	2.00	31.00	22.00	1.00
626103-0244-032	2.00	32.00	23.00	1.00
626103-0244-033	2.00	33.00	24.00	1.00
626103-0244-034	2.00	34.00	25.00	1.00
626113-0200-035	2.00	35.00	26.00	1.50
626113-0201-035	2.00	35.00	26.00	1.00
626113-0203-035	2.00	35.00	26.00	0.80
626103-0244-036	2.00	36.00	27.00	1.00
626103-0244-037	2.00	37.00	28.00	1.00
626113-0200-037	2.00	37.00	28.00	1.50
626103-0244-038	2.00	38.00	29.00	1.00
626103-0244-039	2.00	39.00	30.00	1.00
626113-0201-040	2.00	40.00	31.00	1.50
626113-0202-040	2.00	40.00	31.00	1.00
626103-0244-041	2.00	41.00	32.00	1.00
626103-0244-042	2.00	42.00	33.00	1.00
626103-0244-043	2.00	43.00	34.00	1.00
626103-0244-044	2.00	44.00	35.00	1.00
626103-0244-045	2.00	45.00	36.00	1.00
626113-0201-045	2.00	45.00	36.00	1.50
626103-0244-046	2.00	46.00	37.00	1.00
626103-0244-047	2.00	47.00	38.00	1.00



Article-No.	DK	L	ML	DS
626103-0244-048	2.00	48.00	39.00	1.00
626103-0244-049	2.00	49.00	40.00	1.00
626113-0200-050	2.00	50.00	41.00	1.00
626113-0203-050	2.00	50.00	41.00	1.50
626103-0244-051	2.00	51.00	42.00	1.00
626103-0244-052	2.00	52.00	43.00	1.00
626103-0244-053	2.00	53.00	44.00	1.00
626103-0244-054	2.00	54.00	45.00	1.00
626103-0200-054	2.00	54.00	45.00	1.50
626103-0244-055	2.00	55.00	46.00	1.00
626103-0244-056	2.00	56.00	47.00	1.00
626103-0244-057	2.00	57.00	48.00	1.00
626103-0244-058	2.00	58.00	49.00	1.00
626103-0244-059	2.00	59.00	50.00	1.00
626113-0201-059	2.00	59.00	50.00	1.50
626103-0244-060	2.00	60.00	51.00	1.00
626113-0203-060	2.00	60.00	51.00	1.50
626113-0201-063	2.00	63.00	54.00	1.50
626113-0200-065	2.00	65.00	56.00	1.50
626103-0200-066	2.00	66.00	57.00	1.00
626113-0200-069	2.00	69.00	60.00	1.50
626113-0200-070	2.00	70.00	61.00	1.50
626113-0200-075	2.00	75.00	66.00	1.50
626113-0201-080	2.00	80.00	71.00	1.00
626113-0200-094	2.00	94.00	85.00	1.00
626113-0206-030	2.03	30.00	21.00	1.00
626113-0230-049	2.25	49.00	40.00	1.50
626113-0250-012	2.50	12.00	3.00	1.50
626103-5854-013	2.50	13.00	4.00	1.50
626103-5854-014	2.50	14.00	5.00	1.50
626103-5854-015	2.50	15.00	6.00	1.50
626103-5854-016	2.50	16.00	7.00	1.50
626103-5854-017	2.50	17.00	8.00	1.50
626103-5854-018	2.50	18.00	9.00	1.50
626103-5854-019	2.50	19.00	10.00	1.50
626113-0250-020	2.50	20.00	11.00	1.50
626103-5854-021	2.50	21.00	12.00	1.50
626103-5854-022	2.50	22.00	13.00	1.50
626103-5854-023	2.50	23.00	14.00	1.50
626103-5854-024	2.50	24.00	15.00	1.50
626113-0250-025	2.50	25.00	16.00	1.50
626103-5854-026	2.50	26.00	17.00	1.50
626103-5854-027	2.50	27.00	18.00	1.50
626113-0250-027	2.50	27.00	18.00	1.00
626103-5854-028	2.50	28.00	19.00	1.50
626103-5854-029	2.50	29.00	20.00	1.50
626113-0250-030	2.50	30.00	21.00	1.50
626103-5854-031	2.50	31.00	22.00	1.50
626103-5854-032	2.50	32.00	23.00	1.50
626103-5854-033	2.50	33.00	24.00	1.50
626103-5854-034	2.50	34.00	25.00	1.50





Article-No.	DK	L	ML	DS
626113-0250-035	2.50	35.00	26.00	1.50
626103-5854-036	2.50	36.00	27.00	1.50
626103-5854-037	2.50	37.00	28.00	1.50
626103-5854-038	2.50	38.00	29.00	1.50
626103-5854-039	2.50	39.00	30.00	1.50
626113-0250-040	2.50	40.00	31.00	1.50
626103-5854-041	2.50	41.00	32.00	1.50
626103-5854-042	2.50	42.00	33.00	1.50
626103-5854-043	2.50	43.00	34.00	1.50
626113-0250-044	2.50	44.00	35.00	1.50
626103-5854-045	2.50	45.00	36.00	1.50
626103-5854-046	2.50	46.00	37.00	1.50
626103-5854-047	2.50	47.00	38.00	1.50
626103-5854-048	2.50	48.00	39.00	1.50
626103-5854-049	2.50	49.00	40.00	1.50
626103-5854-050	2.50	50.00	41.00	1.50
626103-5854-051	2.50	51.00	42.00	1.50
626103-5854-052	2.50	52.00	43.00	1.50
626103-5854-053	2.50	53.00	44.00	1.50
626103-5854-054	2.50	54.00	45.00	1.50
626103-5854-055	2.50	55.00	46.00	1.50
626113-0250-055	2.50	55.00	46.00	1.50
626103-5854-056	2.50	56.00	47.00	1.50
626103-5854-057	2.50	57.00	48.00	1.50
626103-5854-058	2.50	58.00	49.00	1.50
626103-5854-059	2.50	59.00	50.00	1.50
626103-5854-060	2.50	60.00	51.00	1.50
626113-0250-080	2.50	80.00	71.00	1.50
626113-0250-090	2.50	90.00	81.00	1.50
626113-0250-100	2.50	100.00	91.00	1.50
626113-0280-030	2.80	30.00	21.00	1.50
626113-0290-034	2.90	34.00	25.00	2.00
626103-0354-013	3.00	13.00	4.00	1.50
626103-0354-014	3.00	14.00	5.00	1.50
626103-0354-015	3.00	15.00	6.00	1.50
626103-0354-016	3.00	16.00	7.00	1.50
626103-0354-017	3.00	17.00	8.00	1.50
626103-0354-018	3.00	18.00	9.00	1.50
626103-0354-019	3.00	19.00	10.00	1.50
626103-0354-020	3.00	20.00	11.00	1.50
626103-0354-021	3.00	21.00	12.00	1.50
626103-0354-022	3.00	22.00	13.00	1.50
626103-0354-023	3.00	23.00	14.00	1.50
626103-0354-024	3.00	24.00	15.00	1.50
626103-0354-025	3.00	25.00	16.00	1.50
626103-0354-026	3.00	26.00	17.00	1.50
626103-0354-027	3.00	27.00	18.00	1.50
626103-0354-028	3.00	28.00	19.00	1.50
626113-0300-029	3.00	29.00	20.00	1.50
626103-0354-030	3.00	30.00	21.00	1.50
626103-0354-031	3.00	31.00	22.00	1.50
626103-0354-032	3.00	32.00	23.00	1.50
626103-0354-033	3.00	33.00	24.00	1.50
626103-0354-034	3.00	34.00	25.00	1.50



Article-No.	DK	L	ML	DS
626103-0354-035	3.00	35.00	26.00	1.50
626103-0300-035	3.00	35.00	26.00	2.00
626103-0354-036	3.00	36.00	27.00	1.50
626103-0354-037	3.00	37.00	28.00	1.50
626103-0354-038	3.00	38.00	29.00	1.50
626103-0354-039	3.00	39.00	30.00	1.50
626103-0354-040	3.00	40.00	31.00	1.50
626113-0305-040	3.00	40.00	31.00	2.00
626103-0354-041	3.00	41.00	32.00	1.50
626103-0354-042	3.00	42.00	33.00	1.50
626113-0301-042	3.00	42.00	33.00	1.50
626103-0354-043	3.00	43.00	34.00	1.50
626103-0354-044	3.00	44.00	35.00	1.50
626103-0354-045	3.00	45.00	36.00	1.50
626103-0354-046	3.00	46.00	37.00	1.50
626103-0354-047	3.00	47.00	38.00	1.50
626113-0301-047	3.00	47.00	38.00	2.00
626103-0354-048	3.00	48.00	39.00	1.50
626103-0354-049	3.00	49.00	40.00	1.50
626103-0354-050	3.00	50.00	41.00	1.50
626113-0305-050	3.00	50.00	41.00	2.00
626103-0354-051	3.00	51.00	42.00	1.50
626103-0354-052	3.00	52.00	43.00	1.50
626103-0354-053	3.00	53.00	44.00	1.50
626103-0354-054	3.00	54.00	45.00	1.50
626103-0354-055	3.00	55.00	46.00	1.50
626103-0354-056	3.00	56.00	47.00	1.50
626103-0354-057	3.00	57.00	48.00	1.50
626103-0354-058	3.00	58.00	49.00	1.50
626113-0300-059	3.00	59.00	50.00	1.50
626113-0301-059	3.00	59.00	50.00	2.00
626103-0354-060	3.00	60.00	51.00	1.50
626113-0300-069	3.00	69.00	60.00	1.50
626113-0300-084	3.00	84.00	75.00	1.50
626113-0300-085	3.00	85.00	76.00	1.50
626113-0301-100	3.00	100.00	91.00	1.50
626113-0350-042	3.50	42.00	33.00	1.50
626113-0350-054	3.50	54.00	45.00	1.50
626113-0350-070	3.50	70.00	61.00	2.00
626113-0350-080	3.50	80.00	71.00	2.00
626113-0401-034	4.00	34.00	25.00	1.50
626103-0401-035	4.00	35.00	26.00	2.00
626113-0401-040	4.00	40.00	31.00	2.00
626103-0404-050	4.00	50.00	41.00	2.00
626113-0403-050	4.00	50.00	41.00	1.50
626103-0401-059	4.00	59.00	50.00	2.00
626113-0401-060	4.00	60.00	51.00	2.00
626113-0400-075	4.00	75.00	66.00	2.00
626113-0450-050	4.50	50.00	41.00	2.00
626113-0450-069	4.50	69.00	60.00	2.00
626113-0450-074	4.50	74.00	65.00	2.00



Article-No.	DK	L	ML	DS
626113-0500-025	5.00	25.00	16.00	1.00
626113-0500-026	5.00	25.50	16.50	2.00
626103-0502-040	5.00	40.00	31.00	2.00
626103-0503-075	5.00	75.00	66.00	2.00
626113-0500-094	5.00	94.00	85.00	2.00
626113-0600-016	6.00	16.00	7.00	2.00
626113-0600-030	6.00	30.00	21.00	2.00
626113-0600-033	6.00	33.00	24.00	2.00
626113-0600-034	6.00	34.40	25.40	2.00
626113-0602-040	6.00	40.00	31.00	3.50
626103-0601-060	6.00	60.00	51.00	3.50
626113-0700-059	7.00	59.00	50.00	2.00
626113-0800-021	8.00	21.00	12.00	2.00
626113-0801-035	8.00	35.00	26.00	2.00
626113-0800-035	8.00	35.20	26.20	1.50
626113-0800-059	8.00	59.00	50.00	2.00
626113-0900-044	9.00	44.00	35.00	3.00

### M3 XXT, Styli straight, ruby sphere, carbon fibre shaft

Standard Styli suitable for all common measuring tasks. M3 thread for ZEISS VAST XXT sensors.

Connection Type: M3 XXT  
 Shaft Material: Carbon Fiber  
 Stylus Tip Geometry: Sphere  
 Stylus Tip Material: Ruby  
 Ø Body (DG): 5

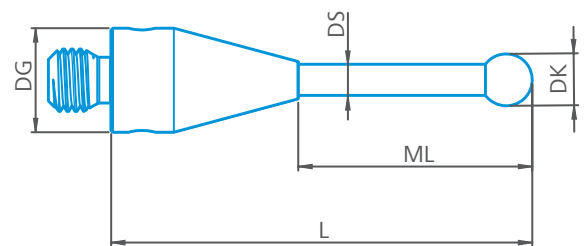

Article-No.	DK	L	ML	DS
626113-0205-030	2.00	30.00	21.00	1.50
626113-0200-046	2.00	46.00	37.00	1.50
626103-0200-058	2.00	58.00	51.00	1.00
626103-0250-075	2.50	75.00	66.00	2.00
626113-0281-050	2.80	50.00	41.00	2.00
626113-0280-125	2.80	125.00	116.00	2.00
626103-0300-022	3.00	21.50	12.50	2.00
626103-0300-025	3.00	25.00	16.00	2.00
626103-0300-033	3.00	33.00	24.00	2.00
626103-0300-040	3.00	40.00	31.00	2.00
626103-0300-042	3.00	42.00	33.00	2.00
626103-0300-050	3.00	50.00	41.00	2.00
626103-0300-053	3.00	53.00	44.00	2.00
626103-0300-055	3.00	55.00	46.00	2.00
626103-0300-058	3.00	58.00	49.00	2.00
626103-0300-059	3.00	59.00	50.00	2.00
626103-0300-060	3.00	60.00	51.00	2.00
626103-0300-065	3.00	65.00	56.00	2.00
626103-0300-068	3.00	68.00	59.00	2.00
626103-0300-069	3.00	69.00	60.00	2.00
626103-0300-070	3.00	70.00	61.00	2.00
626103-0300-075	3.00	75.00	66.00	2.00



Article-No.	DK	L	ML	DS
626103-0300-084	3.00	84.00	75.00	2.00
626103-0300-090	3.00	90.00	81.00	2.00
626103-0300-100	3.00	100.00	91.00	2.00
626103-0300-109	3.00	109.00	100.00	2.00
626103-0300-125	3.00	125.00	116.00	2.00
626103-0300-150	3.00	150.00	141.00	2.00
626103-0300-159	3.00	159.00	150.00	2.00
626103-0350-030	3.50	30.00	21.00	2.00
626103-0350-040	3.50	40.00	31.00	2.00
626103-0350-050	3.50	50.00	41.00	2.00
626113-0351-050	3.50	50.00	41.00	1.50
626103-0350-058	3.50	58.00	49.00	2.00
626103-0350-060	3.50	60.00	51.00	2.00
626103-0350-062	3.50	62.00	53.00	2.00
626103-0350-085	3.50	85.00	76.00	2.00
626103-0350-145	3.50	145.00	136.00	2.00
626103-0401-020	4.00	20.00	11.00	2.00
626103-0403-040	4.00	40.00	31.00	2.00
626103-0401-050	4.00	50.00	41.00	2.00
626103-0400-050	4.00	50.00	41.00	3.50
626103-0400-059	4.00	59.00	50.00	2.00
626103-0410-060	4.00	60.00	51.00	3.50
626103-0400-064	4.00	64.00	55.00	2.00
626103-0400-065	4.00	65.00	56.00	3.50
626103-0400-069	4.00	69.00	60.00	2.00
626103-0400-075	4.00	75.00	66.00	3.50
626103-0402-075	4.00	75.00	66.00	2.00
626103-0400-080	4.00	80.00	71.00	2.00
626103-0400-084	4.00	84.00	75.00	2.00
626103-0402-090	4.00	90.00	81.00	2.00
626103-0400-090	4.00	90.00	81.00	3.50
626103-0400-095	4.00	95.00	86.00	2.00
626103-0400-100	4.00	100.00	91.00	2.00
626103-0400-102	4.00	102.00	93.00	2.00
626113-0400-150	4.00	150.00	141.00	3.00
626103-0400-170	4.00	170.00	161.00	2.00
626103-0450-040	4.50	40.00	31.00	3.50
626103-0450-050	4.50	50.00	41.00	3.50
626113-0450-080	4.50	80.00	71.00	3.50
626113-0450-100	4.50	100.00	91.00	3.50
626103-0500-030	5.00	30.00	21.00	3.50
626103-0505-030	5.00	30.00	21.00	2.00
626103-0500-040	5.00	40.00	31.00	3.50
626103-0500-050	5.00	50.00	41.00	3.50
626103-0500-060	5.00	60.00	51.00	3.50
626103-0501-073	5.00	73.00	64.00	3.50
626103-0501-075	5.00	75.00	66.00	3.50
626103-0500-090	5.00	90.00	81.00	3.50
626103-0500-094	5.00	94.00	85.00	2.00
626103-0501-110	5.00	110.00	101.00	3.50
626103-0500-125	5.00	125.00	116.00	3.50



Article-No.	DK	L	ML	DS
626103-0510-150	5.00	150.00	141.00	3.50
626103-0600-030	6.00	30.00	21.00	3.50
626103-0600-050	6.00	50.00	41.00	3.50
626103-0600-060	6.00	60.00	51.00	3.50
626103-0610-070	6.00	70.00	61.00	3.50
626103-0610-073	6.00	73.00	64.00	3.50
626103-0600-075	6.00	75.00	66.00	3.50
626103-0610-084	6.00	84.00	75.00	3.50
626103-0600-100	6.00	100.00	91.00	3.50
626103-0600-110	6.00	110.00	101.00	3.50
626103-0610-120	6.00	120.00	111.00	3.50
626103-0600-150	6.00	150.00	141.00	3.50
626103-0600-165	6.00	165.00	156.00	3.50
626103-0700-030	7.00	30.00	21.00	3.50
626103-0700-050	7.00	50.00	41.00	3.50
626103-0750-040	7.50	40.00	31.00	3.50
626103-0800-030	8.00	30.00	30.00	5.00
626103-0830-050	8.00	50.00	50.00	5.00
626103-0810-060	8.00	60.00	51.00	3.50
626103-0830-070	8.00	70.00	70.00	5.00
626103-0830-080	8.00	80.00	80.00	5.00
626103-0830-100	8.00	100.00	100.00	5.00
626103-0800-125	8.00	125.00	125.00	5.00
626103-0810-134	8.00	134.00	125.00	3.50
626103-0800-150	8.00	150.00	150.00	5.00
626103-0800-160	8.00	160.00	160.00	5.00
626113-0850-040	8.50	40.00	31.00	2.00
626113-0900-040	9.00	40.00	31.00	2.00
626103-0900-050	9.00	50.00	50.00	5.00
626103-1000-026	10.00	26.00	26.00	5.00
626103-1030-030	10.00	30.00	30.00	5.00
626113-1001-040	10.00	40.00	31.00	2.00
626103-1000-119	10.00	119.00	119.00	5.00
626103-1030-150	10.00	150.00	150.00	5.00
626103-1200-030	12.00	30.00	30.00	5.00
626113-1200-054	12.00	54.00	45.00	4.00
626103-1200-060	12.00	60.00	60.00	5.00

### M3 XXT, Styli straight, ruby sphere, ceramic shaft

Standard Styli suitable for all common measuring tasks. M3 thread for ZEISS VAST XXT sensors.

Connection Type: M3 XXT  
 Shaft Material: Ceramic  
 Stylus Tip Geometry: Sphere  
 Stylus Tip Material: Ruby  
 Ø Body (DG): 5

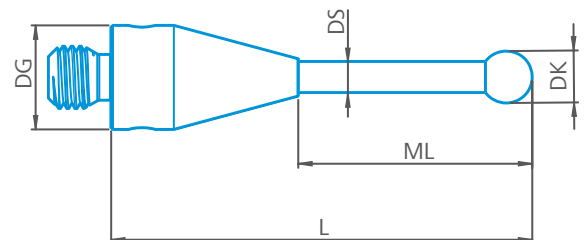

Article-No.	DK	L	ML	DS
626113-0306-050	3.00	50.00	41.00	2.00

## M3 XXT, Styli straight, silicon nitride sphere, tungsten carbide shaft

Standard Styli suitable for all common measuring tasks. M3 thread for ZEISS VAST XXT sensors.

Connection Type: M3 XXT  
 Shaft Material: Tung. Carb.  
 Stylus Tip Geometry: Sphere  
 Stylus Tip Material: Si. Nitride  
 Ø Body (DG): 5

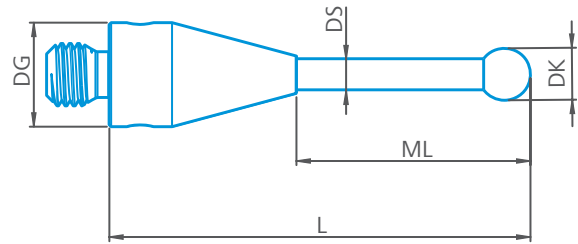

Article-No.	DK	L	ML	DS
626113-0100-013	1.00	13.00	4.00	0.80
626113-0107-020	1.00	20.00	11.00	0.80
626113-0103-030	1.00	30.00	21.00	0.80
626113-0111-030	1.00	30.00	21.00	0.60
626113-0107-040	1.00	40.00	31.00	0.80
626113-0101-049	1.00	49.00	40.00	0.80
626103-5745-013	1.35	13.00	4.00	1.00
626103-5745-014	1.35	14.00	5.00	1.00
626103-5745-015	1.35	15.00	6.00	1.00
626103-5745-016	1.35	16.00	7.00	1.00
626103-5745-017	1.35	17.00	8.00	1.00
626103-5745-018	1.35	18.00	9.00	1.00
626103-5745-019	1.35	19.00	10.00	1.00
626103-5745-020	1.35	20.00	11.00	1.00
626103-5745-021	1.35	21.00	12.00	1.00
626103-5745-022	1.35	22.00	13.00	1.00
626103-5745-023	1.35	23.00	14.00	1.00
626113-0142-024	1.35	24.00	15.00	1.00
626103-5745-025	1.35	25.00	16.00	1.00
626103-5745-026	1.35	26.00	17.00	1.00
626103-5745-027	1.35	27.00	18.00	1.00
626103-5745-028	1.35	28.00	19.00	1.00
626103-5745-029	1.35	29.00	20.00	1.00
626103-5745-030	1.35	30.00	21.00	1.00
626103-5745-031	1.35	31.00	22.00	1.00
626103-5745-032	1.35	32.00	23.00	1.00
626103-5745-033	1.35	33.00	24.00	1.00
626103-5745-034	1.35	34.00	25.00	1.00
626103-5745-035	1.35	35.00	26.00	1.00
626103-5745-036	1.35	36.00	27.00	1.00
626103-5745-037	1.35	37.00	28.00	1.00
626103-5745-038	1.35	38.00	29.00	1.00
626103-5745-039	1.35	39.00	30.00	1.00
626113-0141-040	1.35	40.00	31.00	1.00
626103-5745-041	1.35	41.00	32.00	1.00
626103-5745-042	1.35	42.00	33.00	1.00
626103-5745-043	1.35	43.00	34.00	1.00
626103-5745-044	1.35	44.00	35.00	1.00
626103-5745-045	1.35	45.00	36.00	1.00



Article-No.	DK	L	ML	DS
626103-0145-013	1.50	13.00	4.00	1.00
626113-0152-014	1.50	14.00	5.00	1.00
626103-0145-015	1.50	15.00	6.00	1.00
626103-0145-016	1.50	16.00	7.00	1.00
626103-0145-017	1.50	17.00	8.00	1.00
626103-0145-018	1.50	18.00	9.00	1.00
626103-0145-019	1.50	19.00	10.00	1.00
626113-0153-020	1.50	20.00	11.00	1.00
626103-0145-021	1.50	21.00	12.00	1.00
626103-0145-022	1.50	22.00	13.00	1.00
626103-0145-023	1.50	23.00	14.00	1.00
626103-0145-024	1.50	24.00	15.00	1.00
626103-0145-025	1.50	25.00	16.00	1.00
626103-0145-026	1.50	26.00	17.00	1.00
626103-0145-027	1.50	27.00	18.00	1.00
626103-0145-028	1.50	28.00	19.00	1.00
626103-0145-029	1.50	29.00	20.00	1.00
626113-0155-030	1.50	30.00	21.00	1.00
626113-0153-030	1.50	30.00	22.50	1.00
626103-0145-031	1.50	31.00	22.00	1.00
626103-0145-032	1.50	32.00	23.00	1.00
626103-0145-033	1.50	33.00	24.00	1.00
626103-0145-034	1.50	34.00	25.00	1.00
626103-0145-035	1.50	35.00	26.00	1.00
626103-0145-036	1.50	36.00	27.00	1.00
626103-0145-037	1.50	37.00	28.00	1.00
626103-0145-038	1.50	38.00	29.00	1.00
626103-0145-039	1.50	39.00	30.00	1.00
626113-0152-040	1.50	40.00	31.00	1.00
626103-0145-041	1.50	41.00	32.00	1.00
626103-0145-042	1.50	42.00	33.00	1.00
626103-0145-043	1.50	43.00	34.00	1.00
626103-0145-044	1.50	44.00	35.00	1.00
626103-0145-045	1.50	45.00	36.00	1.00
626103-0145-050	1.50	50.00	41.00	1.00
626113-0151-064	1.50	64.00	55.00	1.00
626113-0151-070	1.50	70.00	61.00	1.00
626103-0255-013	2.00	13.00	4.00	1.50
626103-0245-013	2.00	13.00	4.00	1.00
626103-0255-014	2.00	14.00	5.00	1.50
626113-0201-014	2.00	14.00	5.00	1.00
626103-0255-015	2.00	15.00	6.00	1.50
626103-0245-015	2.00	15.00	6.00	1.00
626103-0255-016	2.00	16.00	7.00	1.50
626103-0245-016	2.00	16.00	7.00	1.00
626103-0255-017	2.00	17.00	8.00	1.50
626103-0245-017	2.00	17.00	8.00	1.00
626103-0255-018	2.00	18.00	9.00	1.50
626103-0245-018	2.00	18.00	9.00	1.00
626103-0255-019	2.00	19.00	10.00	1.50
626103-0245-019	2.00	19.00	10.00	1.00
626103-0255-020	2.00	20.00	11.00	1.50
626113-0203-020	2.00	20.00	11.00	1.00
626103-0255-021	2.00	21.00	12.00	1.50



Article-No.	DK	L	ML	DS
626103-0245-021	2.00	21.00	12.00	1.00
626103-0255-022	2.00	22.00	13.00	1.50
626103-0245-022	2.00	22.00	13.00	1.00
626103-0255-023	2.00	23.00	14.00	1.50
626103-0245-023	2.00	23.00	14.00	1.00
626103-0245-024	2.00	24.00	15.00	1.00
626103-0255-024	2.00	24.00	15.00	1.50
626103-0245-025	2.00	25.00	16.00	1.00
626103-0255-025	2.00	25.00	16.00	1.50
626113-0203-025	2.00	25.00	16.00	0.70
626103-0245-026	2.00	26.00	17.00	1.00
626103-0255-026	2.00	26.00	17.00	1.50
626103-0245-027	2.00	27.00	18.00	1.00
626103-0255-027	2.00	27.00	18.00	1.50
626103-0245-028	2.00	28.00	19.00	1.00
626103-0255-028	2.00	28.00	19.00	1.50
626103-0245-029	2.00	29.00	20.00	1.00
626103-0255-029	2.00	29.00	20.00	1.50
626103-0245-030	2.00	30.00	21.00	1.00
626113-0203-030	2.00	30.00	21.00	1.50
626103-0255-031	2.00	31.00	22.00	1.50
626103-0245-031	2.00	31.00	22.00	1.00
626103-0255-032	2.00	32.00	23.00	1.50
626103-0245-032	2.00	32.00	23.00	1.00
626103-0255-033	2.00	33.00	24.00	1.50
626103-0245-033	2.00	33.00	24.00	1.00
626103-0255-034	2.00	34.00	25.00	1.50
626103-0245-034	2.00	34.00	25.00	1.00
626103-0255-035	2.00	35.00	26.00	1.50
626103-0245-035	2.00	35.00	26.00	1.00
626103-0255-036	2.00	36.00	27.00	1.50
626103-0245-036	2.00	36.00	27.00	1.00
626103-0255-037	2.00	37.00	28.00	1.50
626103-0245-037	2.00	37.00	28.00	1.00
626103-0255-038	2.00	38.00	29.00	1.50
626103-0245-038	2.00	38.00	29.00	1.00
626103-0255-039	2.00	39.00	30.00	1.50
626103-0245-039	2.00	39.00	30.00	1.00
626103-0245-040	2.00	40.00	31.00	1.00
626113-0203-040	2.00	40.00	31.00	1.50
626103-0245-041	2.00	41.00	32.00	1.00
626103-0255-041	2.00	41.00	32.00	1.50
626103-0245-042	2.00	42.00	33.00	1.00
626103-0255-042	2.00	42.00	33.00	1.50
626103-0245-043	2.00	43.00	34.00	1.00
626103-0255-043	2.00	43.00	34.00	1.50
626103-0255-044	2.00	44.00	35.00	1.50
626103-0245-044	2.00	44.00	35.00	1.00
626103-0255-045	2.00	45.00	36.00	1.50
626103-0255-050	2.00	50.00	41.00	1.50
626113-0205-050	2.00	50.00	41.00	1.00





<b>Article-No.</b>	<b>DK</b>	<b>L</b>	<b>ML</b>	<b>DS</b>
626113-0202-060	2.00	60.00	51.00	1.50
626113-0251-020	2.50	20.00	11.00	1.50
626113-0251-022	2.50	22.00	13.00	1.50
626113-0252-030	2.50	30.00	21.00	1.50
626113-0251-040	2.50	40.00	31.00	1.50
626113-0250-050	2.50	50.00	41.00	1.50
626103-0355-013	3.00	13.00	4.00	1.50
626103-0355-014	3.00	14.00	5.00	1.50
626103-0355-015	3.00	15.00	6.00	1.50
626103-0355-016	3.00	16.00	7.00	1.50
626103-0355-017	3.00	17.00	8.00	1.50
626103-0355-018	3.00	18.00	9.00	1.50
626103-0355-019	3.00	19.00	10.00	1.50
626103-0355-020	3.00	20.00	11.00	1.50
626103-0355-021	3.00	21.00	12.00	1.50
626103-0355-022	3.00	22.00	13.00	1.50
626103-0355-023	3.00	23.00	14.00	1.50
626103-0355-024	3.00	24.00	15.00	1.50
626103-0355-025	3.00	25.00	16.00	1.50
626103-0355-026	3.00	26.00	17.00	1.50
626103-0355-027	3.00	27.00	18.00	1.50
626103-0355-028	3.00	28.00	19.00	1.50
626103-0355-029	3.00	29.00	20.00	1.50
626103-0355-030	3.00	30.00	21.00	1.50
626103-0355-031	3.00	31.00	22.00	1.50
626103-0355-032	3.00	32.00	23.00	1.50
626103-0355-033	3.00	33.00	24.00	1.50
626103-0355-034	3.00	34.00	25.00	1.50
626103-0355-035	3.00	35.00	26.00	1.50
626103-0355-036	3.00	36.00	27.00	1.50
626103-0355-037	3.00	37.00	28.00	1.50
626103-0355-038	3.00	38.00	29.00	1.50
626103-0355-039	3.00	39.00	30.00	1.50
626103-0355-040	3.00	40.00	31.00	1.50
626103-0355-041	3.00	41.00	32.00	1.50
626103-0355-042	3.00	42.00	33.00	1.50
626103-0355-043	3.00	43.00	34.00	1.50
626103-0355-044	3.00	44.00	35.00	1.50
626103-0355-045	3.00	45.00	36.00	1.50
626113-0302-050	3.00	50.00	41.00	2.00
626103-0302-058	3.00	58.00	49.00	2.00
626113-0300-079	3.00	79.00	70.00	2.00
626113-0402-040	4.00	40.00	31.00	2.00
626103-0405-050	4.00	50.00	41.00	2.00
626113-0502-053	5.00	52.50	43.50	3.50

## M3 XXT, Styli straight, silicon nitride sphere, carbon fibre shaft

Standard Styli suitable for all common measuring tasks. M3 thread for ZEISS VAST XXT sensors.

Connection Type: M3 XXT  
 Shaft Material: Carbon Fiber  
 Stylus Tip Geometry: Sphere  
 Stylus Tip Material: Si. Nitride  
 Ø Body (DG): 5

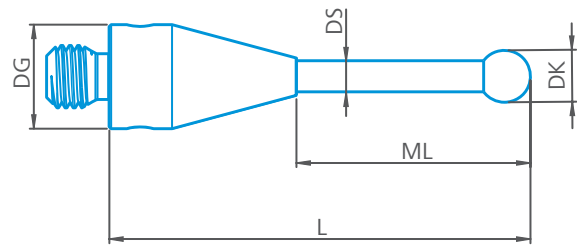

Article-No.	DK	L	ML	DS
626103-0301-025	3.00	25.00	16.00	2.00
626103-0301-033	3.00	33.00	24.00	2.00
626103-0305-040	3.00	40.00	31.00	2.00
626103-0301-042	3.00	42.00	33.00	2.00
626103-0301-049	3.00	49.00	40.00	2.00
626103-0301-058	3.00	58.00	49.00	2.00
626103-0301-065	3.00	65.00	56.00	2.00
626103-0300-074	3.00	74.00	65.00	2.00
626103-0301-075	3.00	75.00	66.00	2.00
626103-0301-084	3.00	84.00	75.00	2.00
626103-0301-100	3.00	100.00	91.00	2.00
626103-0301-125	3.00	125.00	116.00	2.00
626103-0301-150	3.00	150.00	141.00	2.00
626103-0350-065	3.50	65.00	56.00	2.00
626103-0401-040	4.00	40.00	31.00	2.00
626103-0402-050	4.00	50.00	41.00	2.00
626103-0401-075	4.00	75.00	66.00	2.00
626103-0401-100	4.00	100.00	91.00	2.00
626103-0400-125	4.00	125.00	116.00	3.50
626103-0502-030	5.00	30.00	21.00	3.50
626103-0501-040	5.00	40.00	31.00	3.50
626103-0502-050	5.00	50.00	41.00	3.50
626103-0501-060	5.00	60.00	51.00	3.50
626103-0500-075	5.00	75.00	66.00	3.50
626103-0502-075	5.00	75.00	66.00	2.00
626103-0500-100	5.00	100.00	91.00	3.50
626103-0500-110	5.00	110.00	101.00	3.50
626103-0601-050	6.00	50.00	41.00	3.50
626103-0600-070	6.00	70.00	61.00	3.50
626103-0601-100	6.00	100.00	91.00	3.50
626103-0601-150	6.00	150.00	141.00	3.50
626103-0801-030	8.00	30.00	30.00	5.00
626103-0801-050	8.00	50.00	50.00	5.00
626103-0801-070	8.00	70.00	70.00	5.00
626103-0800-100	8.00	100.00	100.00	5.00
626103-0801-125	8.00	125.00	125.00	5.00
626103-1000-075	10.00	75.00	75.00	5.00
626103-1051-110	10.00	110.00	110.00	5.00
626103-1051-150	10.00	150.00	150.00	5.00

## M3 XXT, Styli stepped, ruby sphere, tungsten carbide shaft

Standard Styli suitable for all common measuring tasks. M3 thread for ZEISS VAST XXT sensors.

Connection Type: M3 XXT  
 Shaft Material: Tung. Carb.  
 Stylus Tip Geometry: Sphere  
 Stylus Tip Material: Ruby  
 Ø Body (DG): 5

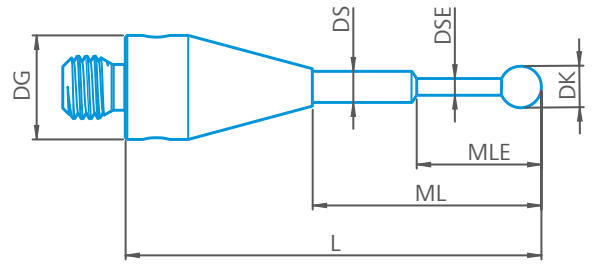

Article-No.	DK	L	ML	DS	MLE	DSE
626103-5144-013	0.20	13.00	4.00	1.00	3.00	0.15
626103-5144-014	0.20	14.00	5.00	1.00	3.00	0.15
626103-5144-015	0.20	15.00	6.00	1.00	3.00	0.15
626103-5144-016	0.20	16.00	7.00	1.00	3.00	0.15
626103-5144-017	0.20	17.00	8.00	1.00	3.00	0.15
626103-5144-018	0.20	18.00	9.00	1.00	3.00	0.15
626103-5144-019	0.20	19.00	10.00	1.00	3.00	0.15
626103-5144-020	0.20	20.00	11.00	1.00	3.00	0.15
626103-5144-021	0.20	21.00	12.00	1.00	3.00	0.15
626103-5144-022	0.20	22.00	13.00	1.00	3.00	0.15
626103-5144-023	0.20	23.00	14.00	1.00	3.00	0.15
626103-5144-024	0.20	24.00	15.00	1.00	3.00	0.15
626113-0020-025	0.20	25.00	16.00	1.00	3.00	0.15
626113-0025-011	0.25	11.00	5.00	1.00	2.50	0.20
626113-0030-025	0.25	25.00	11.00	0.80	4.00	0.20
626113-0030-013	0.30	13.00	4.00	1.00	2.30	0.20
626103-5244-014	0.30	14.00	5.00	1.00	2.30	0.20
626113-0030-015	0.30	15.00	6.00	1.00	2.30	0.20
626103-5244-016	0.30	16.00	7.00	1.00	2.30	0.20
626113-0030-016	0.30	16.00	7.00	1.00	4.00	0.20
626103-5244-017	0.30	17.00	8.00	1.00	2.30	0.20
626113-0030-017	0.30	17.00	8.00	1.00	5.00	0.20
626113-0030-018	0.30	18.00	9.00	1.00	2.30	0.20
626113-0031-019	0.30	19.00	10.00	0.50	2.30	0.20
626113-0030-020	0.30	20.00	11.00	1.00	2.30	0.20
626103-5244-021	0.30	21.00	12.00	1.00	2.30	0.20
626103-5244-022	0.30	22.00	13.00	1.00	2.30	0.20
626103-5244-023	0.30	23.00	14.00	1.00	2.30	0.20
626113-0031-023	0.30	23.00	14.00	1.00	5.00	0.20
626103-5244-024	0.30	24.00	15.00	1.00	2.30	0.20
626103-5244-025	0.30	25.00	16.00	1.00	2.30	0.20
626113-0036-025	0.30	25.00	16.00	0.50	2.30	0.20
626113-0031-025	0.30	25.00	11.00	0.80	4.00	0.20
626113-0030-030	0.30	30.00	21.00	1.00	2.30	0.20
626113-0033-030	0.30	30.00	21.00	1.00	4.00	0.20
626113-0040-013	0.40	13.00	4.00	1.00	2.30	0.30
626103-5344-014	0.40	14.00	5.00	1.00	2.30	0.30
626113-0040-015	0.40	15.00	6.00	1.00	2.30	0.30
626103-5344-016	0.40	16.00	7.00	1.00	2.30	0.30
626103-5344-017	0.40	17.00	8.00	1.00	2.30	0.30
626103-5344-018	0.40	18.00	9.00	1.00	2.30	0.30
626103-5344-019	0.40	19.00	10.00	1.00	2.30	0.30



Article-No.	DK	L	ML	DS	MLE	DSE
626113-0040-020	0.40	20.00	11.00	1.00	2.30	0.30
626103-5344-021	0.40	21.00	12.00	1.00	2.30	0.30
626103-5344-022	0.40	22.00	13.00	1.00	2.30	0.30
626103-5344-023	0.40	23.00	14.00	1.00	2.30	0.30
626103-5344-024	0.40	24.00	15.00	1.00	2.30	0.30
626103-5344-025	0.40	25.00	16.00	1.00	2.30	0.30
626103-5444-012	0.50	12.00	3.00	1.00	2.30	0.30
626113-0050-013	0.50	13.00	4.00	1.00	2.30	0.30
626113-0051-013	0.50	13.00	4.00	1.00	2.30	0.30
626103-5444-014	0.50	14.00	5.00	1.00	2.30	0.30
626113-0050-015	0.50	15.00	6.00	1.00	2.30	0.30
626113-0050-016	0.50	15.50	6.50	1.00	2.30	0.30
626103-5444-016	0.50	16.00	7.00	1.00	2.30	0.30
626103-5444-017	0.50	17.00	8.00	1.00	2.30	0.30
626113-0050-017	0.50	17.00	8.00	1.00	4.60	0.40
626113-0050-018	0.50	18.00	9.00	1.00	2.30	0.30
626103-5444-019	0.50	19.00	10.00	1.00	2.30	0.30
626113-0050-020	0.50	20.00	11.00	1.00	2.30	0.30
626113-0052-020	0.50	20.00	11.00	1.00	5.50	0.30
626103-0050-020	0.50	20.00	11.00	1.00	5.00	0.30
626113-0058-020	0.50	20.00	11.00	1.00	3.50	0.30
626113-0051-020	0.50	20.00	11.00	1.00	2.30	0.30
626103-5444-021	0.50	21.00	12.00	1.00	2.30	0.30
626103-5444-022	0.50	22.00	13.00	1.00	2.30	0.30
626103-5444-023	0.50	23.00	14.00	1.00	2.30	0.30
626113-0050-023	0.50	23.00	14.00	1.00	6.00	0.30
626113-0051-024	0.50	24.00	15.00	1.00	2.30	0.30
626113-0050-024	0.50	24.00	15.00	2.00	8.00	0.30
626113-0053-024	0.50	24.00	15.00	1.00	7.50	0.30
626113-0052-024	0.50	24.00	15.00	1.00	7.00	0.40
626103-5444-025	0.50	25.00	16.00	1.00	2.30	0.30
626113-0050-025	0.50	25.00	16.00	1.00	5.50	0.40
626113-0050-030	0.50	30.00	21.00	1.00	8.00	0.30
626113-0054-030	0.50	30.00	21.00	0.80	15.00	0.30
626113-0050-034	0.50	34.00	25.00	2.00	11.00	0.40
626113-0050-040	0.50	40.00	31.00	1.00	5.00	0.35
626113-0051-040	0.50	40.00	31.00	1.00	7.00	0.30
626113-0051-041	0.50	41.00	32.00	2.00	11.00	0.40
626113-0050-050	0.50	50.00	41.00	1.00	5.00	0.30
626113-0060-014	0.60	14.00	5.00	1.00	4.60	0.40
626103-5544-015	0.60	15.00	6.00	1.00	4.60	0.40
626103-5544-016	0.60	16.00	7.00	1.00	4.60	0.40
626113-0060-017	0.60	17.00	8.00	1.00	4.60	0.40
626103-5544-018	0.60	18.00	9.00	1.00	4.60	0.40
626103-5544-019	0.60	19.00	10.00	1.00	4.60	0.40
626113-0060-020	0.60	20.00	11.00	1.00	4.60	0.40
626113-0067-020	0.60	20.00	11.00	1.00	8.50	0.40
626113-0066-020	0.60	20.00	11.00	1.00	7.00	0.40
626103-5544-021	0.60	21.00	12.00	1.00	4.60	0.40
626103-5544-022	0.60	22.00	13.00	1.00	4.60	0.40
626103-5544-023	0.60	23.00	14.00	1.00	4.60	0.40



Article-No.	DK	L	ML	DS	MLE	DSE
626113-0061-024	0.60	24.00	15.00	1.00	4.60	0.40
626113-0060-024	0.60	24.00	15.00	2.00	8.00	0.40
626103-5544-025	0.60	25.00	16.00	1.00	4.60	0.40
626113-0060-035	0.60	35.00	26.00	1.00	4.80	0.50
626113-0070-017	0.70	17.00	8.00	1.00	4.80	0.50
626113-0071-020	0.70	20.00	11.00	1.00	7.00	0.50
626113-0082-024	0.70	24.00	15.00	1.00	2.30	0.40
626113-0070-026	0.70	26.00	17.00	1.00	13.00	0.50
626103-5644-014	0.80	14.00	5.00	1.00	4.80	0.60
626103-5644-015	0.80	15.00	6.00	1.00	4.80	0.60
626103-5644-016	0.80	16.00	7.00	1.00	4.80	0.60
626113-0080-017	0.80	17.00	8.00	1.00	4.80	0.60
626103-5644-018	0.80	18.00	9.00	1.00	4.80	0.60
626103-5644-019	0.80	19.00	10.00	1.00	4.80	0.60
626113-0080-020	0.80	20.00	11.00	1.00	4.80	0.60
626103-5644-021	0.80	21.00	12.00	1.00	4.80	0.60
626103-5644-022	0.80	22.00	13.00	1.00	4.80	0.60
626103-5644-023	0.80	23.00	14.00	1.00	4.80	0.60
626103-5644-024	0.80	24.00	15.00	1.00	4.80	0.60
626113-0081-024	0.80	24.00	15.00	2.00	8.00	0.60
626113-0080-025	0.80	25.00	16.00	1.00	4.80	0.60
626113-0081-025	0.80	25.00	16.00	1.00	11.50	0.60
626103-5644-026	0.80	26.00	17.00	1.00	4.80	0.60
626103-5644-027	0.80	27.00	18.00	1.00	4.80	0.60
626113-0080-027	0.80	27.00	18.00	1.00	10.00	0.60
626103-5644-028	0.80	28.00	19.00	1.00	4.80	0.60
626113-0080-028	0.80	28.00	19.00	1.00	7.00	0.40
626103-5644-029	0.80	29.00	20.00	1.00	4.80	0.60
626103-5644-030	0.80	30.00	21.00	1.00	4.80	0.60
626103-5644-031	0.80	31.00	22.00	1.00	4.80	0.60
626103-5644-032	0.80	32.00	23.00	1.00	4.80	0.60
626103-5644-033	0.80	33.00	24.00	1.00	4.80	0.60
626103-5644-034	0.80	34.00	25.00	1.00	4.80	0.60
626113-0080-034	0.80	34.00	25.00	1.00	4.10	0.60
626113-0081-034	0.80	34.40	25.40	1.00	15.40	0.60
626113-0081-035	0.80	35.00	26.00	1.00	4.80	0.60
626113-0080-035	0.80	35.00	26.00	1.00	10.00	0.60
626113-0082-035	0.80	35.00	26.00	1.00	7.00	0.60
626113-0080-040	0.80	40.00	31.00	1.00	4.80	0.60
626113-0081-041	0.80	41.00	32.00	2.00	11.00	0.60
626103-0044-015	1.00	15.00	6.00	1.00	5.00	0.80
626103-0044-016	1.00	16.00	7.00	1.00	5.00	0.80
626103-0044-017	1.00	17.00	8.00	1.00	5.00	0.80
626103-0044-018	1.00	18.00	9.00	1.00	5.00	0.80
626103-0044-019	1.00	19.00	10.00	1.00	5.00	0.80
626113-0100-020	1.00	20.00	11.00	1.00	5.00	0.80
626113-0101-020	1.00	20.00	11.00	1.00	5.10	0.60
626103-0044-021	1.00	21.00	12.00	1.00	5.00	0.80
626103-0044-022	1.00	22.00	13.00	1.00	5.00	0.80
626103-0044-023	1.00	23.00	14.00	1.00	5.00	0.80
626103-0044-024	1.00	24.00	15.00	1.00	5.00	0.80
626113-0100-025	1.00	25.00	16.00	1.00	5.00	0.80
626113-0105-025	1.00	25.00	16.00	1.00	5.00	0.60
626103-0044-026	1.00	26.00	17.00	1.00	5.00	0.80

Article-No.	DK	L	ML	DS	MLE	DSE
626103-0044-027	1.00	27.00	18.00	1.00	5.00	0.80
626103-0044-028	1.00	28.00	19.00	1.00	5.00	0.80
626103-0044-029	1.00	29.00	20.00	1.00	5.00	0.80
626113-0100-030	1.00	30.00	21.00	1.00	5.00	0.80
626113-0104-030	1.00	30.00	21.00	0.80	10.00	0.60
626103-0044-031	1.00	31.00	22.00	1.00	5.00	0.80
626103-0044-032	1.00	32.00	23.00	1.00	5.00	0.80
626103-0044-033	1.00	33.00	24.00	1.00	5.00	0.80
626103-0044-034	1.00	34.00	25.00	1.00	5.00	0.80
626113-0100-035	1.00	35.00	26.00	1.00	5.00	0.80
626103-0102-035	1.00	35.00	26.00	1.00	5.00	0.80
626103-0044-036	1.00	36.00	27.00	1.00	5.00	0.80
626103-0044-037	1.00	37.00	28.00	1.00	5.00	0.80
626103-0044-038	1.00	38.00	29.00	1.00	5.00	0.80
626103-0044-039	1.00	39.00	30.00	1.00	5.00	0.80
626113-0100-040	1.00	40.00	31.00	1.00	5.00	0.80
626113-0103-040	1.00	40.00	31.00	1.00	5.00	0.60
626113-0106-040	1.00	40.00	31.00	1.00	15.00	0.80
626103-0044-041	1.00	41.00	32.00	1.00	5.00	0.80
626103-0044-042	1.00	42.00	33.00	1.00	5.00	0.80
626103-0044-043	1.00	43.00	34.00	1.00	5.00	0.80
626103-0044-044	1.00	44.00	35.00	1.00	5.00	0.80
626103-0044-045	1.00	45.00	36.00	1.00	5.00	0.80
626113-0101-045	1.00	45.00	36.00	1.00	15.00	0.80
626113-0100-045	1.00	45.00	34.00	2.00	18.00	0.70
626113-0100-049	1.00	49.00	40.00	0.80	20.00	0.60
626113-0100-054	1.00	54.00	45.00	1.00	10.00	0.80
626113-0151-059	1.00	59.00	50.00	1.50	10.50	0.80
626113-0101-060	1.00	60.00	55.00	3.00	21.00	0.80
626113-0100-070	1.00	70.00	61.00	1.50	10.00	0.80
626113-0121-030	1.20	30.00	21.00	1.00	5.60	0.80
626113-0150-034	1.50	34.00	25.00	1.00	10.00	0.70
626113-0151-050	1.50	50.00	41.00	1.50	16.00	1.00
626113-0153-060	1.50	60.00	51.00	3.00	16.00	1.30
626113-0300-120	3.00	120.00	111.00	2.50	20.00	2.00
626113-0500-050	5.00	50.00	41.00	3.00	20.00	2.00



## M3 XXT, Styli stepped, silicon nitride sphere, tungsten carbide shaft

Standard Styli suitable for all common measuring tasks. M3 thread for ZEISS VAST XXT sensors.

Connection Type: M3 XXT  
 Shaft Material: Tung. Carb.  
 Stylus Tip Geometry: Sphere  
 Stylus Tip Material: Si. Nitride  
 Ø Body (DG): 5

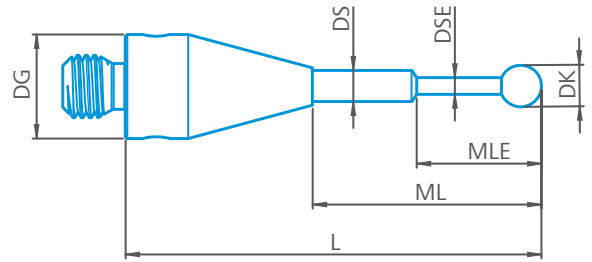

Article-No.	DK	L	ML	DS	MLE	DSE
626103-5245-015	0.30	15.00	6.00	1.00	2.30	0.20
626113-0036-020	0.30	20.00	11.00	1.00	2.30	0.20
626113-0035-025	0.30	25.00	16.00	1.00	2.30	0.20
626113-0055-020	0.50	20.00	12.50	0.75	5.00	0.30
626113-0059-020	0.50	20.00	11.00	1.00	2.50	0.30
626113-0089-020	0.80	20.00	11.00	1.00	4.80	0.60
626103-5645-025	0.80	25.00	16.00	1.00	4.80	0.60
626103-0045-014	1.00	14.00	5.00	1.00	5.00	0.80
626103-0045-015	1.00	15.00	6.00	1.00	5.00	0.80
626103-0045-016	1.00	16.00	7.00	1.00	5.00	0.80
626103-0045-017	1.00	17.00	8.00	1.00	5.00	0.80
626103-0045-018	1.00	18.00	9.00	1.00	5.00	0.80
626103-0045-019	1.00	19.00	10.00	1.00	5.00	0.80
626113-0102-020	1.00	20.00	11.00	1.00	5.00	0.80
626103-0045-021	1.00	21.00	12.00	1.00	5.00	0.80
626103-0045-022	1.00	22.00	13.00	1.00	5.00	0.80
626103-0045-023	1.00	23.00	14.00	1.00	5.00	0.80
626103-0045-024	1.00	24.00	15.00	1.00	5.00	0.80
626113-0101-025	1.00	25.00	16.00	1.00	5.00	0.80
626103-0045-026	1.00	26.00	17.00	1.00	5.00	0.80
626103-0045-027	1.00	27.00	18.00	1.00	5.00	0.80
626103-0045-028	1.00	28.00	19.00	1.00	5.00	0.80
626103-0045-029	1.00	29.00	20.00	1.00	5.00	0.80
626113-0105-030	1.00	30.00	21.00	1.00	5.00	0.80
626103-0045-031	1.00	31.00	22.00	1.00	5.00	0.80
626103-0045-032	1.00	32.00	23.00	1.00	5.00	0.80
626103-0045-033	1.00	33.00	24.00	1.00	5.00	0.80
626103-0045-034	1.00	34.00	25.00	1.00	5.00	0.80
626113-0101-035	1.00	35.00	26.00	1.00	5.00	0.80
626113-0102-035	1.00	35.00	26.00	2.00	12.50	0.70
626103-0045-036	1.00	36.00	27.00	1.00	5.00	0.80
626103-0045-037	1.00	37.00	28.00	1.00	5.00	0.80
626103-0045-038	1.00	38.00	29.00	1.00	5.00	0.80
626103-0045-039	1.00	39.00	30.00	1.00	5.00	0.80
626113-0101-040	1.00	40.00	31.00	1.00	5.00	0.80
626103-0045-041	1.00	41.00	32.00	1.00	5.00	0.80
626103-0045-042	1.00	42.00	33.00	1.00	5.00	0.80
626103-0045-043	1.00	43.00	34.00	1.00	5.00	0.80
626103-0045-044	1.00	44.00	35.00	1.00	5.00	0.80
626103-0045-045	1.00	45.00	36.00	1.00	5.00	0.80
626113-0102-060	1.00	60.00	55.00	3.00	21.00	0.80
626113-0101-074	1.00	74.00	65.00	3.00	20.00	0.70
626113-0201-074	2.00	74.00	65.00	3.00	40.00	1.50
626113-0300-074	3.00	74.00	65.00	3.00	20.00	1.50
626113-0401-074	4.00	74.00	65.00	3.00	20.00	1.50

## Knurled styli

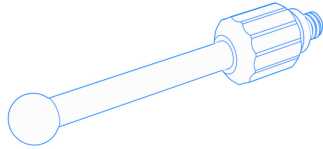

These innovative styli with plastic coated thread are a cost-saving alternative to standard styli. Their carbon fibre shaft is tipped with a ruby sphere and has been especially designed for the use with the VAST XXT probe. Beneath the cost factor there is the benefit, that these styli can be mounted without any tools. Compared to conventional styli, these styli have a knurled plastic adapter with titanium core. The styli can thus be screwed in and fastened by hand.

### M3 XXT, Knurled styli, ruby sphere, carbon fibre shaft

Standard Styli suitable for all common measuring tasks. Knurled plastic adapter for assembly without tools. M3 thread for ZEISS VAST XXT sensors.

Connection Type: M3 XXT  
 Shaft Material: Carbon Fiber  
 Stylus Tip Geometry: Sphere  
 Stylus Tip Material: Ruby  
 Ø Body (DG): 5

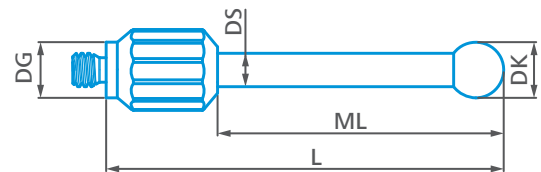

Article-No.	DK	L	ML	DS
626103-0207-020	2.00	20.00	8.00	1.00
626103-0207-025	2.00	25.00	13.00	1.00
626103-0207-030	2.00	30.00	18.00	1.00
626103-5000-007	2.00	30.00	18.00	1.00
626103-0307-030	3.00	30.00	18.00	2.00
626103-0307-040	3.00	40.00	28.00	2.00
626103-0307-050	3.00	50.00	38.00	2.00
626103-0307-061	3.00	60.50	50.50	2.00
626103-0507-040	5.00	40.00	30.00	3.00
626103-0507-050	5.00	50.00	40.00	3.00
626103-0507-060	5.00	60.00	50.00	3.00
626103-0507-075	5.00	75.00	65.00	3.00
626103-0807-040	8.00	40.00	30.00	3.00



## M3 XXT, Knurled styli, silicon nitride sphere, carbon fibre shaft

Standard Styli suitable for all common measuring tasks. Knurled plastic adapter for assembly without tools. M3 thread for ZEISS VAST XXT sensors.

Connection Type: M3 XXT  
 Shaft Material: Carbon Fiber  
 Stylus Tip Geometry: Sphere  
 Stylus Tip Material: Si. Nitride  
 Ø Body (DG): 5

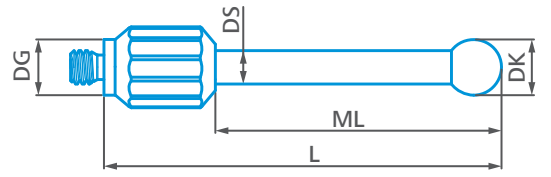

Article-No.	DK	L	ML	DS
626103-0208-030	2.00	30.00	18.00	1.00
626103-0308-050	3.00	50.00	38.00	2.00

## Clamping styli

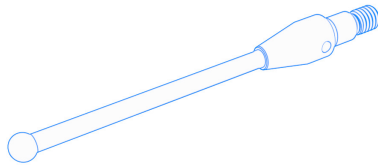

Clamping styli have an extended adapter compared to conventional styli. This means that it consists of the actual adapter and a fitting cylinder between the adapter and the thread. This allows the M3 XXT star elements to be clamped directly via the stylus in the same way as with a clamping screw. The other dimensions of the stylus correspond to those of the comparable standard stylus

### M3 XXT, Clamping styli straight, ruby sphere, carbon fibre shaft

Clamping styli that also serves as the the clamping screw for star elements. M3 thread for ZEISS VAST XXT probes.

Connection Type: M3 XXT  
 Shaft Material: Carbon Fiber  
 Stylus Tip Geometry: Sphere  
 Stylus Tip Material: Ruby  
 Ø Body (DG): 5

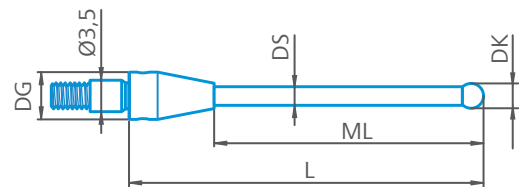

Article-No.	DK	L	ML	DS
626103-0301-020	3.00	20.00	11.00	2.00
626103-0301-030	3.00	30.00	21.00	2.00
626103-0301-040	3.00	40.00	31.00	2.00
626103-0302-050	3.00	50.00	41.00	2.00
626103-0301-060	3.00	60.00	51.00	2.00
626103-0301-070	3.00	70.00	61.00	2.00
626103-0503-050	5.00	50.00	41.00	3.50

### M3 XXT, Clamping styli straight, silicon nitride sphere, carbon fibre shaft

Clamping styli that also serves as the the clamping screw for star elements. M3 thread for ZEISS VAST XXT probes.

Connection Type: M3 XXT  
 Shaft Material: Carbon Fiber  
 Stylus Tip Geometry: Sphere  
 Stylus Tip Material: Si. Nitride  
 Ø Body (DG): 5

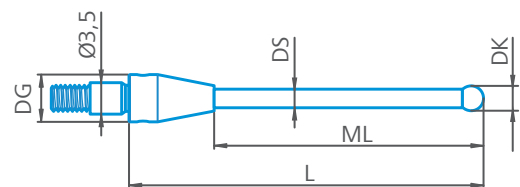

Article-No.	DK	L	ML	DS
626103-0311-020	3.00	20.00	11.00	2.00
626103-0311-030	3.00	30.00	21.00	2.00
626103-0311-040	3.00	40.00	31.00	2.00
626103-0301-050	3.00	50.00	41.00	2.00

# Diamond!Scan®

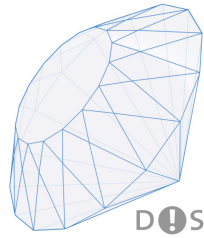

The ZEISS Diamond!Scan® portfolio has been specially developed for scanning ultra-hard ceramic surfaces or ultra-soft aluminum alloys. It is comprised of diamond or diamond-coated ball elements. ZEISS Diamond!Scan spheres are free from material and wear, so these styli can be used reliably in continuous operation without the need for time-consuming inspection and cleaning. The higher purchase price can thus be amortized quickly by the resulting time savings. ZEISS Diamond!Scan styli are available in 3 different versions, pure, carbo and mono. This ensures that you always have the right stylus available for your specific application.

## M3 XXT, Styli straight, diamond coated sphere, tungsten carbide shaft

Diamond coated styli with sphere and shaft made of one piece for the highest stability and accuracy. M3 thread for ZEISS VAST XXT probes.

Connection Type: M3 XXT  
 Shaft Material: Tung. Carb.  
 Stylus Tip Geometry: Sphere-Segment  
 Stylus Tip Material: Diamond Coated  
 Ø Body (DG): 5

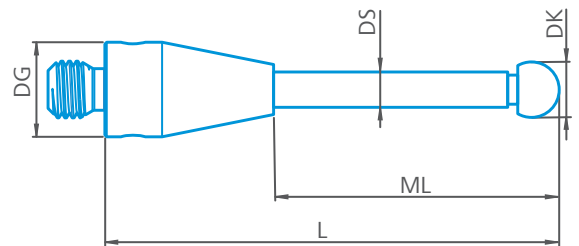

Article-No.	DK	L	ML	DS
626113-0129-016	1.00	16.00	7.00	0.80
626113-0029-024	1.35	24.00	15.00	1.00
626113-0029-016	1.50	16.00	7.00	1.00
626113-0029-025	1.50	25.00	16.00	1.00
626113-0129-029	1.50	29.00	20.00	1.00
626113-0329-030	1.50	30.00	21.00	1.00
626113-0029-021	2.00	21.00	12.00	1.50
626113-0129-040	2.00	40.00	31.00	1.50
626113-0029-064	2.00	64.00	55.00	1.50
626113-0029-035	3.00	35.00	26.00	2.00
626113-0229-040	3.00	40.00	31.00	2.00
626113-0129-050	3.00	50.00	41.00	2.00
626113-0029-079	3.00	79.00	70.00	2.00
626113-0129-079	4.00	79.00	70.00	2.00
626113-0329-050	5.00	50.00	41.00	3.50

### M3 XXT, Styli stepped, diamond coated sphere, tungsten carbide shaft

Diamond coated styli with sphere and shaft made of one piece for the highest stability and accuracy. M3 thread for ZEISS VAST XXT probes.

Connection Type: M3 XXT  
 Shaft Material: Tung. Carb.  
 Stylus Tip Geometry: Sphere-Segment  
 Stylus Tip Material: Diamond Coated  
 Ø Body (DG): 5

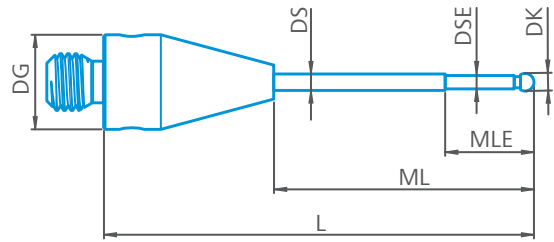

Article-No.	DK	L	ML	DS	MLE	DSE
626113-0129-025	1.00	25.00	16.00	1.00	5.00	0.80
626113-0329-040	1.00	40.00	31.00	1.00	5.00	0.80

### M3 XXT, Styli straight, diamond sphere, tungsten carbide shaft

Styli with a full diamond sphere for scanning applications were one side of the sphere is commonly used. M3 thread for ZEISS VAST XXT probes.

Connection Type: M3 XXT  
 Shaft Material: Tung. Carb.  
 Stylus Tip Geometry: Sphere  
 Stylus Tip Material: Diamond  
 Ø Body (DG): 5

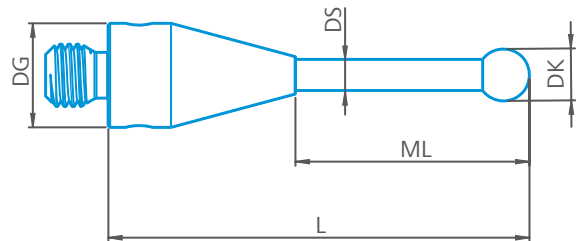

Article-No.	DK	L	ML	DS
626113-0209-030	2.00	30.00	21.00	1.50
626113-0209-034	2.00	34.00	25.00	1.50
626113-0209-051	2.00	51.00	42.00	1.50

### M3 XXT, Styli stepped, diamond sphere, tungsten carbide shaft

Styli with a full diamond sphere for scanning applications were one side of the sphere is commonly used. M3 thread for ZEISS VAST XXT probes.

Connection Type: M3 XXT  
 Shaft Material: Tung. Carb.  
 Stylus Tip Geometry: Sphere  
 Stylus Tip Material: Diamond  
 Ø Body (DG): 5

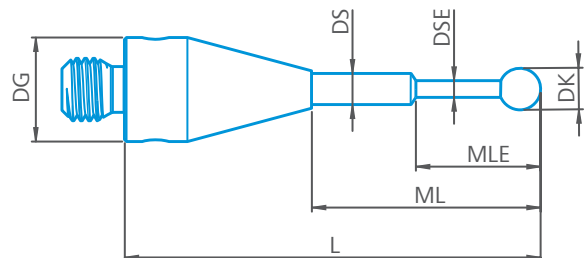

Article-No.	DK	L	ML	DS	MLE	DSE
626113-0109-020	1.00	20.00	11.00	1.00	5.00	0.80

### M3 XXT, Styli straight, diamond sphere, carbon fibre shaft

Styli with a full diamond sphere for scanning tasks in which mostly one point on the sphere is used. M3 thread for ZEISS VAST XXT probes.

Connection Type: M3 XXT  
 Shaft Material: Carbon Fiber  
 Stylus Tip Geometry: Sphere  
 Stylus Tip Material: Diamond  
 Ø Body (DG): 5

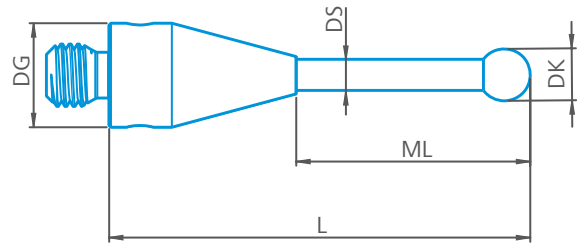

Article-No.	DK	L	ML	DS
626103-0309-033	3.00	33.00	24.00	2.00
626103-0309-040	3.00	40.00	31.00	2.00
626103-0309-050	3.00	50.00	41.00	2.00
626103-0309-059	3.00	59.00	50.00	2.00

### M3 XXT, Styli straight, diamond coated sphere, carbon fiber shaft

Stylus with a diamond-coated sphere for scanning tasks that place the highest demands on material deposits and wear. Suitable for measuring magnetic components. M3 thread for ZEISS VAST XXT probes.

Connection Type: M3 XXT  
 Shaft Material: Carbon Fiber  
 Stylus Tip Geometry: Sphere  
 Stylus Tip Material: Diamond Coated  
 Ø Body (DG): 5

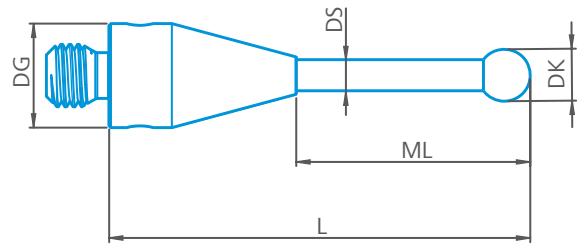

Article-No.	DK	L	ML	DS
626103-0319-033	3.05	33.00	24.00	2.00
626103-0319-050	3.05	50.00	41.00	2.00
626103-0319-075	3.05	75.00	66.00	2.00
626103-0419-050	4.05	50.00	41.00	2.00
626103-0419-075	4.05	75.00	66.00	3.50
626103-0019-125	5.05	125.00	116.00	3.50

## Cylinder styli

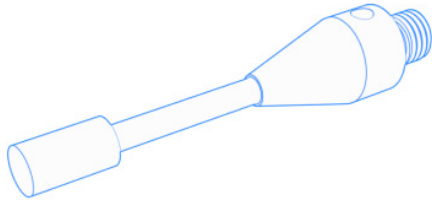

Cylindrical styli measure two-dimensionally and are particularly suitable for thin sheets. Narrow workpiece edges can also be measured well with cylindrical measuring probes. However, the probe axis must be mechanically aligned very precisely with the feature axis on the workpiece. As a special form, spherical cylindrical styli are available, which are also mostly used for sheet metal measurement and measurement at sheet metal edges. They have spherical end and can thus additionally determine the flatness of a surface, for example.

### M3 XXT, Spherical cylinder styli, spherical ruby cylinder, tungsten carbide shaft

Cylindrical styli for thin sheets and narrow workpiece edges. In addition surface measurement with the spherical tip. M3 thread for ZEISS VAST XXT probes.

Connection Type: M3 XXT  
 Shaft Material: Tung. Carb.  
 Stylus Tip Geometry: Spherical Cylinder  
 Stylus Tip Material: Ruby  
 Ø Body (DG): 5

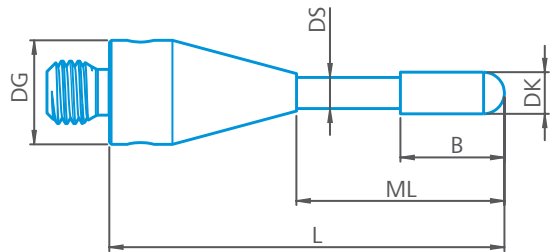

Article-No.	DK	L	ML	DS
626113-0201-016	2.00	16.00	7.00	2.00

### M3 XXT, Spherical cylinder styli, spherical ruby cylinder, without shaft

Cylindrical styli for thin sheets and narrow workpiece edges. In addition surface measurement with the spherical tip. M3 thread for ZEISS VAST XXT probes.

Connection Type: M3 XXT  
 Shaft Material: Ruby  
 Stylus Tip Geometry: Spherical Cylinder  
 Stylus Tip Material: Ruby  
 Ø Body (DG): 5

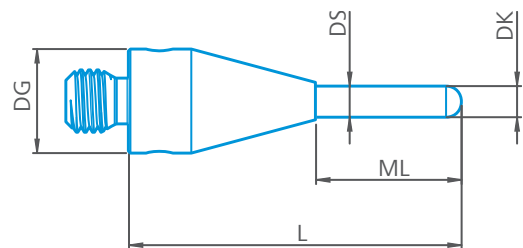

Article-No.	DK	L	ML	DS
626113-0100-016	1.00	16.00	7.00	1.00
626113-0151-016	1.50	16.00	7.00	1.50

## M3 XXT, Spherical cylinder styli, spherical tungsten carbide cylinder, without shaft

Cylindrical styli for thin sheets and narrow workpiece edges. In addition surface measurement with the spherical tip. M3 thread for ZEISS VAST XXT probes.

Connection Type: M3 XXT  
 Shaft Material: Tung. Carb.  
 Stylus Tip Geometry: Spherical Cylinder  
 Stylus Tip Material: Tung. Carb.  
 Ø Body (DG): 5

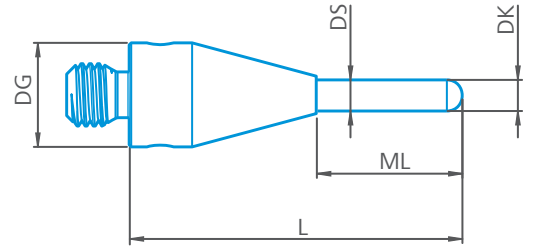

Article-No.	DK	L	ML	DS
626113-5000-238	1.00	14.00	5.00	1.00
626113-5000-239	1.00	20.00	11.00	1.00
626113-5000-180	1.00	35.50	26.50	1.00
626113-5000-198	1.50	16.00	7.00	1.50
626113-5000-199	2.00	16.00	7.00	2.00
626113-5000-047	2.00	29.00	20.00	2.00

## Disc styli

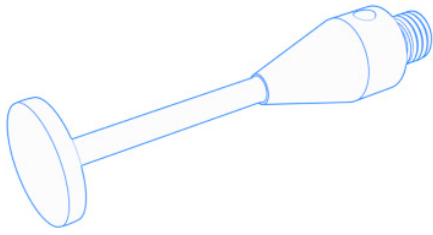

The special technology of the ZEISS VAST XXT probe head does not permit the use of disc styli. When calibrating disc styli, a data error is generated which may lead to wrong measuring results. The use of disc styli without consulting ZEISS is not recommended. In exceptional cases, disc styli can be qualified on ZEISS VAST XXT probes using a special procedure. In such cases, please contact [accessories.metrology.de@zeiss.com](mailto:accessories.metrology.de@zeiss.com)



# Hemisphere styli

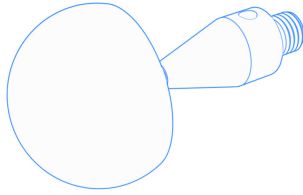

Hemisphere styli are suitable for measuring undercuts as well as for those applications that require a large diameter of the stylus tip with low weight. To enhance this effect, n is a distinction made between hemispherical and hollow hemispherical styli. Hollow hemispheres are produced using a complex manufacturing process in order to achieve maximum weight savings. For VAST XXT probes, hemisphere styli are not suitable for weight reasons. Only hollow hemisphere styli are used here.

## M3 XXT, Hollow-hemisphere styli, ceramic

Hollow hemisphere styli for applications that require a large diameter and lowest weight. M3 thread for ZEISS VAST XXT probes.

- Connection Type: M3 XXT
- Shaft Material: Titanium
- Stylus Tip Geometry: Hollow-Hemisphere
- Stylus Tip Material: Ceramic
- Ø Body (DG): 5

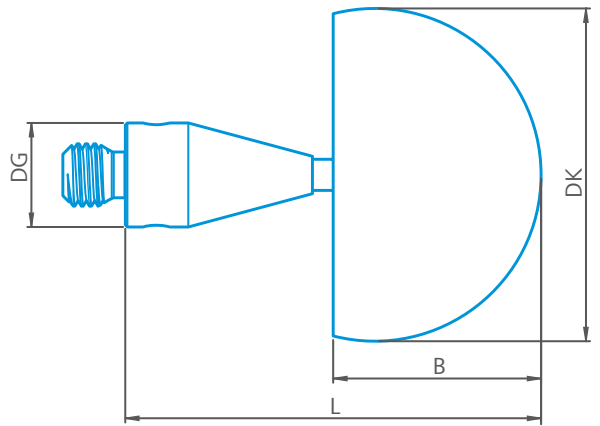

Article-No.	DK	L	B
626103-1200-012	12.00	12.00	8.00
626103-1500-012	15.00	12.00	9.00
626103-1801-018	18.00	17.50	11.60
626103-2000-019	20.00	18.50	13.00
626103-2200-019	22.00	18.50	14.50
626103-2500-019	25.00	18.50	15.50
626113-5000-067	28.00	21.00	18.00

## M3 REN

Styli with M3 thread suitable for ZEISS RST, Renishaw SP and Hexagon HP-S sensors



Styli with M3 thread suitable for ZEISS RST, Renishaw SP and Hexagon HP-S sensors. M3 styli can also be connected to other thread systems using the appropriate adaptors and connecting elements. Styli spheres are made of ruby or silicon nitride. In addition to the standard spherical styli, cylindrical styli made of tungsten carbide and ruby are also available. The standard straight shaft is made of tungsten carbide, but a stepped shaft is also available to provide additional stiffness.

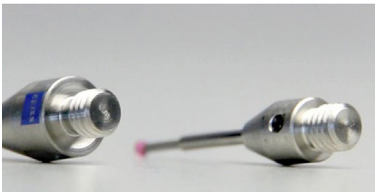

### M3 REN is not equal to M3 XXT

Caution: M3 REN and M3 XXT systems cannot be combined due to their different design (diameter adapter (DG) M3 REN: 4mm; M3 XXT: 5mm); weak interfaces and incorrect measurements would be the result.

### ZEISS RST-P - Fast and dynamic measurement data capture

The ZEISS RST-P works according to the dual principle. This means: on the one hand, piezoelectric elements arranged in front of the kink point supply the actual probing pulse. On the other hand, a three-point bearing serves as a mechanical kink point that confirms the probing and protects the sensor against damage due to contact with the workpiece and collision. Furthermore, the deflection forces caused by the bearings and direction do not influence the measuring result: the ZEISS RST-P delivers consistent accuracy in all probing directions. Special calibration is not required for slanted measuring jobs or probings.



# Styli Standard

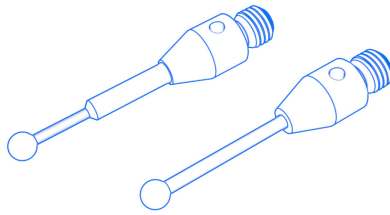

Spherical styli have the largest field of application because they have the same probing behavior in every direction. They are therefore suitable for all common measuring tasks such as measuring bores and surfaces. The larger the stylus sphere size, the larger the mechanical filter. This means that the profile of your workpiece is smoothed, which is often required in form measurement. The deviation from the ideal sphere shape is usually shown in Grade. ZEISS stylus tips come standard with Grade 5, but can also be offered with highly accurate roundness or diameters with a certificate for special requirements. Styli with a straight shaft are the most simple designed styli. The full shaft length can be used as measuring length. Stepped shaft has the advantage of a greater shaft thickness, which is reduced towards the measuring tip. This stepped shaft increases the stability of the shaft while maintaining the same length (depending on the sphere diameter). At the same time, however, the usable measuring length is reduced.

## M3 REN, Styli straight, ruby sphere, tungsten carbide shaft

Standard Styli suitable for all common measuring tasks. M3 thread for ZEISS RST, Renishaw SP and Hexagon HP-S sensors.

Not for ZEISS VAST XXT sensors (see product notes).

Connection Type: M3  
 Shaft Material: Tung. Carb.  
 Stylus Tip Geometry: Sphere  
 Stylus Tip Material: Ruby  
 Ø Body (DG): 4

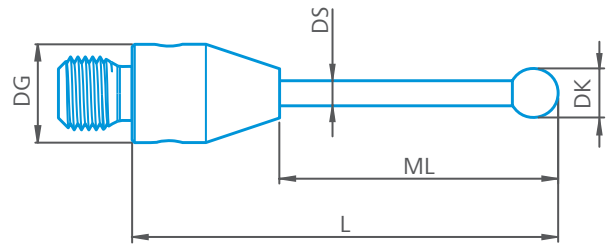

Article-No.	DK	L	ML	DS
626113-0051-010	0.50	10.00	5.00	0.30
626113-0050-010	0.50	10.00	5.00	0.40
626113-0060-019	0.60	19.00	13.00	0.40
626113-0072-020	0.70	20.00	13.00	0.50
626113-0070-027	0.70	27.40	20.40	0.60
626113-0081-010	0.80	10.00	4.00	0.60
626113-0080-024	0.80	23.40	16.00	0.60
626113-0100-007	1.00	6.50	2.50	0.70
602030-8120-000	1.00	10.50	5.50	0.80
626113-0150-015	1.00	15.00	9.00	0.70
626113-0100-021	1.00	21.00	14.00	0.70
626113-0101-022	1.00	22.00	7.00	0.80
000000-1260-251	1.00	22.00	15.00	0.60
626113-0100-027	1.00	27.00	21.00	0.80
626113-0100-059	1.00	59.00	52.00	0.80
626113-0120-027	1.20	27.00	21.00	0.70
626113-0120-032	1.20	32.00	26.00	0.70
626113-0130-020	1.30	20.00	13.00	1.00



Article-No.	DK	L	ML	DS
626123-5744-009	1.35	9.00	3.00	1.00
626123-5744-010	1.35	10.00	4.00	1.00
626123-5744-011	1.35	11.00	5.00	1.00
626123-5744-012	1.35	12.00	6.00	1.00
626123-5744-013	1.35	13.00	7.00	1.00
626123-5744-014	1.35	14.00	8.00	1.00
626123-5744-015	1.35	15.00	9.00	1.00
626123-5744-016	1.35	16.00	10.00	1.00
626123-5744-017	1.35	17.00	11.00	1.00
626123-5744-018	1.35	18.00	12.00	1.00
626123-5744-019	1.35	19.00	13.00	1.00
626123-5744-020	1.35	20.00	14.00	1.00
626113-0140-020	1.35	20.00	14.00	1.00
626123-5744-021	1.35	21.00	15.00	1.00
626123-5744-022	1.35	22.00	16.00	1.00
626123-5744-023	1.35	23.00	17.00	1.00
626123-5744-024	1.35	24.00	18.00	1.00
626123-5744-025	1.35	25.00	19.00	1.00
626123-5744-026	1.35	26.00	20.00	1.00
626123-5744-027	1.35	27.00	21.00	1.00
626123-5744-028	1.35	28.00	22.00	1.00
626123-5744-029	1.35	29.00	23.00	1.00
626123-5744-030	1.35	30.00	24.00	1.00
626123-5744-031	1.35	31.00	25.00	1.00
626123-5744-032	1.35	32.00	26.00	1.00
626123-5744-033	1.35	33.00	27.00	1.00
626123-5744-034	1.35	34.00	28.00	1.00
626123-5744-035	1.35	35.00	29.00	1.00
626123-5744-036	1.35	36.00	30.00	1.00
626123-5744-037	1.35	37.00	31.00	1.00
626123-5744-038	1.35	38.00	32.00	1.00
626123-5744-039	1.35	39.00	33.00	1.00
626123-5744-040	1.35	40.00	34.00	1.00
626123-5744-041	1.35	41.00	35.00	1.00
626123-5744-042	1.35	42.00	36.00	1.00
626123-5744-043	1.35	43.00	37.00	1.00
626123-5744-044	1.35	44.00	38.00	1.00
626123-5744-045	1.35	45.00	39.00	1.00
626113-0141-021	1.40	20.70	13.70	1.00
626113-0140-026	1.40	26.00	20.00	1.00
626123-0144-009	1.50	9.00	3.00	1.00
626123-0144-010	1.50	10.00	4.00	1.00
626123-0144-011	1.50	11.00	5.00	1.00
626123-0144-012	1.50	12.00	6.00	1.00
626123-0144-013	1.50	13.00	7.00	1.00
626123-0144-014	1.50	14.00	8.00	1.00
626123-0144-015	1.50	15.00	9.00	1.00
626123-0144-016	1.50	16.00	10.00	1.00
626123-0144-017	1.50	17.00	11.00	1.00
626123-0144-018	1.50	18.00	12.00	1.00
626123-0144-019	1.50	19.00	13.00	1.00



Article-No.	DK	L	ML	DS
626123-0144-020	1.50	20.00	14.00	1.00
626123-0144-021	1.50	21.00	15.00	1.00
602030-8119-000	1.50	22.00	9.00	1.00
626123-0144-022	1.50	22.00	16.00	1.00
626123-0144-023	1.50	23.00	17.00	1.00
626123-0144-024	1.50	24.00	18.00	1.00
626123-0144-025	1.50	25.00	19.00	1.00
626123-0144-026	1.50	26.00	20.00	1.00
626123-0144-027	1.50	27.00	21.00	1.00
626123-0144-028	1.50	28.00	22.00	1.00
626123-0144-029	1.50	29.00	23.00	1.00
626113-0150-030	1.50	30.00	22.50	1.00
626123-0144-030	1.50	30.00	24.00	1.00
626120-0263-000	1.50	30.75	23.25	1.00
626123-0144-031	1.50	31.00	25.00	1.00
626123-0144-032	1.50	32.00	26.00	1.00
626123-0144-033	1.50	33.00	27.00	1.00
626123-0144-034	1.50	34.00	28.00	1.00
626123-0144-035	1.50	35.00	29.00	1.00
626123-0144-036	1.50	36.00	30.00	1.00
626123-0144-037	1.50	37.00	31.00	1.00
626123-0144-038	1.50	38.00	32.00	1.00
626123-0144-039	1.50	39.00	33.00	1.00
626123-0144-040	1.50	40.00	34.00	1.00
626123-0144-041	1.50	41.00	35.00	1.00
626123-0144-042	1.50	42.00	36.00	1.00
626123-0144-043	1.50	43.00	37.00	1.00
626123-0144-044	1.50	44.00	38.00	1.00
626123-0144-045	1.50	45.00	39.00	1.00
626113-0150-052	1.50	52.00	45.00	1.00
626113-0150-055	1.50	55.00	48.00	1.00
626113-0160-035	1.60	35.00	28.00	1.00
626113-0160-037	1.60	37.00	30.00	1.00
626113-0180-037	1.80	37.00	30.00	1.30
626123-0244-009	2.00	9.00	3.00	1.00
626123-0254-009	2.00	9.00	3.00	1.50
626123-0254-010	2.00	10.00	4.00	1.50
626123-0244-010	2.00	10.00	4.00	1.00
626123-0244-011	2.00	11.00	5.00	1.00
626123-0254-011	2.00	11.00	5.00	1.50
626123-0244-012	2.00	12.00	6.00	1.00
626123-0254-012	2.00	12.00	6.00	1.50
626123-0244-013	2.00	13.00	7.00	1.00
626123-0254-013	2.00	13.00	7.00	1.50
626123-0244-014	2.00	14.00	8.00	1.00
626123-0254-014	2.00	14.00	8.00	1.50
626123-0244-015	2.00	15.00	9.00	1.00
626123-0254-015	2.00	15.00	9.00	1.50
626123-0244-016	2.00	16.00	10.00	1.00
626123-0254-016	2.00	16.00	10.00	1.50
626123-0244-017	2.00	17.00	11.00	1.00
626123-0254-017	2.00	17.00	11.00	1.50
626123-0244-018	2.00	18.00	12.00	1.00
626123-0254-018	2.00	18.00	12.00	1.50



Article-No.	DK	L	ML	DS
626123-0244-019	2.00	19.00	13.00	1.00
626123-0254-019	2.00	19.00	13.00	1.50
626123-0244-020	2.00	20.00	14.00	1.00
626123-0254-020	2.00	20.00	14.00	1.50
602030-8023-000	2.00	21.00	15.00	1.00
626123-0244-021	2.00	21.00	15.00	1.00
626123-0254-021	2.00	21.00	15.00	1.50
626113-0200-022	2.00	21.50	15.50	1.50
602030-8104-000	2.00	22.00	14.00	1.00
626123-0244-022	2.00	22.00	16.00	1.00
626123-0254-022	2.00	22.00	16.00	1.50
626123-0244-023	2.00	23.00	17.00	1.00
626123-0254-023	2.00	23.00	17.00	1.50
626123-0244-024	2.00	24.00	18.00	1.00
626123-0254-024	2.00	24.00	18.00	1.50
626123-0244-025	2.00	25.00	19.00	1.00
626123-0254-025	2.00	25.00	19.00	1.50
626123-0244-026	2.00	26.00	20.00	1.00
626123-0254-026	2.00	26.00	20.00	1.50
626123-0244-027	2.00	27.00	21.00	1.00
626123-0254-027	2.00	27.00	21.00	1.50
626123-0244-028	2.00	28.00	22.00	1.00
626123-0254-028	2.00	28.00	22.00	1.50
626123-0244-029	2.00	29.00	23.00	1.00
626123-0254-029	2.00	29.00	23.00	1.50
626123-0244-030	2.00	30.00	24.00	1.00
626123-0254-030	2.00	30.00	24.00	1.50
626113-0201-030	2.00	30.00	21.00	1.00
626123-0244-031	2.00	31.00	25.00	1.00
626123-0254-031	2.00	31.00	25.00	1.50
626123-0244-032	2.00	32.00	26.00	1.00
626123-0254-032	2.00	32.00	26.00	1.50
626123-0244-033	2.00	33.00	27.00	1.00
626123-0254-033	2.00	33.00	27.00	1.50
626123-0244-034	2.00	34.00	28.00	1.00
626123-0254-034	2.00	34.00	28.00	1.50
626123-0244-035	2.00	35.00	29.00	1.00
626123-0254-035	2.00	35.00	29.00	1.50
626123-0244-036	2.00	36.00	30.00	1.00
626123-0254-036	2.00	36.00	30.00	1.50
626123-0244-037	2.00	37.00	31.00	1.00
626123-0254-037	2.00	37.00	31.00	1.50
626113-0200-038	2.00	37.50	31.50	1.00
626123-0244-038	2.00	38.00	32.00	1.00
626123-0254-038	2.00	38.00	32.00	1.50
626123-0244-039	2.00	39.00	33.00	1.00
626123-0254-039	2.00	39.00	33.00	1.50
626123-0244-040	2.00	40.00	34.00	1.00
626123-0254-040	2.00	40.00	34.00	1.50
626123-0244-041	2.00	41.00	35.00	1.00
626123-0254-041	2.00	41.00	35.00	1.50



Article-No.	DK	L	ML	DS
626123-0244-042	2.00	42.00	36.00	1.00
626123-0254-042	2.00	42.00	36.00	1.50
626123-0244-043	2.00	43.00	37.00	1.00
626123-0254-043	2.00	43.00	37.00	1.50
626123-0244-044	2.00	44.00	38.00	1.00
626123-0254-044	2.00	44.00	38.00	1.50
626123-0244-045	2.00	45.00	39.00	1.00
626123-0254-045	2.00	45.00	39.00	1.50
626113-0200-045	2.00	45.00	32.00	1.50
626123-0254-046	2.00	46.00	40.00	1.50
626123-0254-047	2.00	47.00	41.00	1.50
626113-0200-048	2.00	47.50	41.50	1.00
626123-0254-048	2.00	48.00	42.00	1.50
626123-0254-049	2.00	49.00	43.00	1.50
626123-0254-050	2.00	50.00	44.00	1.50
626123-0254-051	2.00	51.00	45.00	1.50
626123-0254-052	2.00	52.00	46.00	1.50
626123-0254-053	2.00	53.00	47.00	1.50
626123-0254-054	2.00	54.00	48.00	1.50
626123-0254-055	2.00	55.00	49.00	1.50
626123-0254-056	2.00	56.00	50.00	1.50
626123-0254-057	2.00	57.00	51.00	1.50
626113-0200-057	2.00	57.50	50.00	1.50
626123-0254-058	2.00	58.00	52.00	1.50
626123-0254-059	2.00	59.00	53.00	1.50
626123-0254-060	2.00	60.00	54.00	1.50
626113-0200-063	2.00	63.00	50.00	1.00
626113-0200-077	2.00	77.50	70.50	1.50
626113-0200-083	2.00	83.00	70.00	1.00
626113-0200-103	2.00	103.00	90.00	1.00
626113-0200-036	2.03	36.00	30.00	1.50
626123-5854-009	2.50	9.00	3.00	1.50
626123-5854-010	2.50	10.00	4.00	1.50
626123-5854-011	2.50	11.00	5.00	1.50
626123-5854-012	2.50	12.00	6.00	1.50
626123-5854-013	2.50	13.00	7.00	1.50
626123-5854-014	2.50	14.00	8.00	1.50
626123-5854-015	2.50	15.00	9.00	1.50
626113-0250-014	2.50	15.00	7.50	1.20
626123-5854-016	2.50	16.00	10.00	1.50
626123-5854-017	2.50	17.00	11.00	1.50
626123-5854-018	2.50	18.00	12.00	1.50
626123-5854-019	2.50	19.00	13.00	1.50
626123-5854-020	2.50	20.00	14.00	1.50
626123-5854-021	2.50	21.00	15.00	1.50
626123-5854-022	2.50	22.00	16.00	1.50
626123-5854-023	2.50	23.00	17.00	1.50
626123-5854-024	2.50	24.00	18.00	1.50
626123-5854-025	2.50	25.00	19.00	1.50
626123-5854-026	2.50	26.00	20.00	1.50
626123-5854-027	2.50	27.00	21.00	1.50
626123-5854-028	2.50	28.00	22.00	1.50
626123-5854-029	2.50	29.00	23.00	1.50
626123-5854-030	2.50	30.00	24.00	1.50



Article-No.	DK	L	ML	DS
626123-5854-031	2.50	31.00	25.00	1.50
626123-5854-032	2.50	32.00	26.00	1.50
626123-5854-033	2.50	33.00	27.00	1.50
626123-5854-034	2.50	34.00	28.00	1.50
626123-5854-035	2.50	35.00	29.00	1.50
626123-5854-036	2.50	36.00	30.00	1.50
626123-5854-037	2.50	37.00	31.00	1.50
626123-5854-038	2.50	38.00	32.00	1.50
626123-5854-039	2.50	39.00	33.00	1.50
626123-5854-040	2.50	40.00	34.00	1.50
626113-0252-040	2.50	40.00	34.00	1.50
626123-5854-041	2.50	41.00	35.00	1.50
626123-5854-042	2.50	42.00	36.00	1.50
626123-5854-043	2.50	43.00	37.00	1.50
626123-5854-044	2.50	44.00	38.00	1.50
626123-5854-045	2.50	45.00	39.00	1.50
626123-5854-046	2.50	46.00	40.00	1.50
626123-5854-047	2.50	47.00	41.00	1.50
626123-5854-048	2.50	48.00	42.00	1.50
626123-5854-049	2.50	49.00	43.00	1.50
626123-5854-050	2.50	50.00	44.00	1.50
626123-5854-051	2.50	51.00	45.00	1.50
626123-5854-052	2.50	52.00	46.00	1.50
626123-5854-053	2.50	53.00	47.00	1.50
626123-5854-054	2.50	54.00	48.00	1.50
626123-5854-055	2.50	55.00	49.00	1.50
626123-5854-056	2.50	56.00	50.00	1.50
626123-5854-057	2.50	57.00	51.00	1.50
626123-5854-058	2.50	58.00	52.00	1.50
626113-0250-058	2.50	58.00	51.00	2.00
626123-5854-059	2.50	59.00	53.00	1.50
626123-5854-060	2.50	60.00	54.00	1.50
626123-0304-009	3.00	9.00	3.00	2.00
626123-0354-009	3.00	9.00	3.00	1.50
626123-0304-010	3.00	10.00	4.00	2.00
626123-0354-010	3.00	10.00	4.00	1.50
626123-0354-011	3.00	11.00	5.00	1.50
626123-0304-011	3.00	11.00	5.00	2.00
626123-0354-012	3.00	12.00	6.00	1.50
626123-0304-012	3.00	12.00	6.00	2.00
626123-0354-013	3.00	13.00	7.00	1.50
626123-0304-013	3.00	13.00	7.00	2.00
626123-0354-014	3.00	14.00	8.00	1.50
626123-0304-014	3.00	14.00	8.00	2.00
626123-0354-015	3.00	15.00	9.00	1.50
626123-0304-015	3.00	15.00	9.00	2.00
626123-0354-016	3.00	16.00	10.00	1.50
626123-0304-016	3.00	16.00	10.00	2.00
626123-0354-017	3.00	17.00	11.00	1.50
626123-0304-017	3.00	17.00	11.00	2.00
626113-0300-020	3.00	17.00	10.00	1.00





Article-No.	DK	L	ML	DS
626123-0354-018	3.00	18.00	12.00	1.50
626123-0304-018	3.00	18.00	12.00	2.00
626123-0354-019	3.00	19.00	13.00	1.50
626123-0304-019	3.00	19.00	13.00	2.00
626123-0354-020	3.00	20.00	14.00	1.50
626123-0304-020	3.00	20.00	14.00	2.00
602030-8106-000	3.00	21.00	13.00	2.00
626123-0354-021	3.00	21.00	15.00	1.50
626123-0304-021	3.00	21.00	15.00	2.00
602030-8021-000	3.00	21.50	15.50	1.50
626123-0354-022	3.00	22.00	16.00	1.50
626123-0304-022	3.00	22.00	16.00	2.00
626123-0354-023	3.00	23.00	17.00	1.50
626123-0304-023	3.00	23.00	17.00	2.00
626123-0354-024	3.00	24.00	18.00	1.50
626123-0304-024	3.00	24.00	18.00	2.00
626123-0354-025	3.00	25.00	19.00	1.50
626123-0304-025	3.00	25.00	19.00	2.00
626123-0354-026	3.00	26.00	20.00	1.50
626123-0304-026	3.00	26.00	20.00	2.00
626123-0354-027	3.00	27.00	21.00	1.50
626123-0304-027	3.00	27.00	21.00	2.00
626123-0354-028	3.00	28.00	22.00	1.50
626123-0304-028	3.00	28.00	22.00	2.00
626123-0354-029	3.00	29.00	23.00	1.50
626123-0304-029	3.00	29.00	23.00	2.00
626123-0354-030	3.00	30.00	24.00	1.50
626123-0304-030	3.00	30.00	24.00	2.00
626123-0354-031	3.00	31.00	25.00	1.50
626123-0304-031	3.00	31.00	25.00	2.00
612030-9384-000	3.00	31.50	24.50	1.50
626120-0160-000	3.00	31.50	24.00	2.00
626123-0354-032	3.00	32.00	26.00	1.50
626123-0304-032	3.00	32.00	26.00	2.00
626123-0354-033	3.00	33.00	27.00	1.50
626123-0304-033	3.00	33.00	27.00	2.00
626123-0354-034	3.00	34.00	28.00	1.50
626123-0304-034	3.00	34.00	28.00	2.00
626123-0354-035	3.00	35.00	29.00	1.50
626123-0304-035	3.00	35.00	29.00	2.00
626123-0354-036	3.00	36.00	30.00	1.50
626123-0304-036	3.00	36.00	30.00	2.00
626113-0300-035	3.00	36.50	30.50	2.00
626123-0354-037	3.00	37.00	31.00	1.50
626123-0304-037	3.00	37.00	31.00	2.00
626123-0354-038	3.00	38.00	32.00	1.50
626123-0304-038	3.00	38.00	32.00	2.00
626123-0354-039	3.00	39.00	33.00	1.50
626123-0304-039	3.00	39.00	33.00	2.00
626123-0354-040	3.00	40.00	34.00	1.50
626123-0304-040	3.00	40.00	34.00	2.00
626123-0354-041	3.00	41.00	35.00	1.50
626123-0304-041	3.00	41.00	35.00	2.00
626120-0009-000	3.00	41.50	34.00	2.00



Article-No.	DK	L	ML	DS
626123-0354-042	3.00	42.00	36.00	1.50
626123-0304-042	3.00	42.00	36.00	2.00
626123-0354-043	3.00	43.00	37.00	1.50
626123-0304-043	3.00	43.00	37.00	2.00
626123-0354-044	3.00	44.00	38.00	1.50
626123-0304-044	3.00	44.00	38.00	2.00
626123-0354-045	3.00	45.00	39.00	1.50
626123-0304-045	3.00	45.00	39.00	2.00
626123-0354-046	3.00	46.00	40.00	1.50
626123-0304-046	3.00	46.00	40.00	2.00
626113-0300-047	3.00	46.50	40.50	1.50
626123-0354-047	3.00	47.00	41.00	1.50
626123-0304-047	3.00	47.00	41.00	2.00
626123-0354-048	3.00	48.00	42.00	1.50
626123-0304-048	3.00	48.00	42.00	2.00
626123-0354-049	3.00	49.00	43.00	1.50
626123-0304-049	3.00	49.00	43.00	2.00
626113-0300-050	3.00	49.50	41.50	2.00
626123-0354-050	3.00	50.00	44.00	1.50
626123-0304-050	3.00	50.00	44.00	2.00
626123-0354-051	3.00	51.00	45.00	1.50
626123-0304-051	3.00	51.00	45.00	2.00
626123-0354-052	3.00	52.00	46.00	1.50
626123-0304-052	3.00	52.00	46.00	2.00
626123-0354-053	3.00	53.00	47.00	1.50
626123-0304-053	3.00	53.00	47.00	2.00
626123-0354-054	3.00	54.00	48.00	1.50
626123-0304-054	3.00	54.00	48.00	2.00
626123-0354-055	3.00	55.00	49.00	1.50
626123-0304-055	3.00	55.00	49.00	2.00
626123-0354-056	3.00	56.00	50.00	1.50
626123-0304-056	3.00	56.00	50.00	2.00
626123-0354-057	3.00	57.00	51.00	1.50
626123-0304-057	3.00	57.00	51.00	2.00
626113-0300-057	3.00	57.50	50.00	2.00
626123-0354-058	3.00	58.00	52.00	1.50
626123-0304-058	3.00	58.00	52.00	2.00
626123-0354-059	3.00	59.00	53.00	1.50
626123-0304-059	3.00	59.00	53.00	2.00
626123-0354-060	3.00	60.00	54.00	1.50
626123-0304-060	3.00	60.00	54.00	2.00
626113-0300-060	3.00	60.00	53.00	1.80
626123-0304-061	3.00	61.00	55.00	2.00
626123-0304-062	3.00	62.00	56.00	2.00
626123-0304-063	3.00	63.00	57.00	2.00
626123-0304-064	3.00	64.00	58.00	2.00
626123-0304-065	3.00	65.00	59.00	2.00
626123-0304-066	3.00	66.00	60.00	2.00
626123-0304-067	3.00	67.00	61.00	2.00
626123-0304-068	3.00	68.00	62.00	2.00
626123-0304-069	3.00	69.00	63.00	2.00



Article-No.	DK	L	ML	DS
626123-0304-070	3.00	70.00	64.00	2.00
626123-0304-071	3.00	71.00	65.00	2.00
626123-0304-072	3.00	72.00	66.00	2.00
626123-0304-073	3.00	73.00	67.00	2.00
626123-0304-074	3.00	74.00	68.00	2.00
626123-0304-075	3.00	75.00	69.00	2.00
626123-0304-076	3.00	76.00	70.00	2.00
626123-0304-077	3.00	77.00	71.00	2.00
626123-0304-078	3.00	78.00	72.00	2.00
626123-0304-079	3.00	79.00	73.00	2.00
626123-0304-080	3.00	80.00	74.00	2.00
626123-0304-081	3.00	81.00	75.00	2.00
626123-0304-082	3.00	82.00	76.00	2.00
626123-0304-083	3.00	83.00	77.00	2.00
626123-0304-084	3.00	84.00	78.00	2.00
626123-0304-085	3.00	85.00	79.00	2.00
626123-0304-086	3.00	86.00	80.00	2.00
626123-0304-087	3.00	87.00	81.00	2.00
626123-0304-088	3.00	88.00	82.00	2.00
626123-0304-089	3.00	89.00	83.00	2.00
626123-0304-090	3.00	90.00	84.00	2.00
626123-0304-091	3.00	91.00	85.00	2.00
626123-0304-092	3.00	92.00	86.00	2.00
626123-0304-093	3.00	93.00	87.00	2.00
626123-0304-094	3.00	94.00	88.00	2.00
626123-0304-095	3.00	95.00	89.00	2.00
626123-0304-097	3.00	97.00	91.00	2.00
626113-0300-100	3.00	100.00	90.00	2.00
626113-0300-107	3.00	107.00	100.00	2.00
626123-0454-009	4.00	9.00	3.00	1.50
626123-0454-010	4.00	10.00	4.00	1.50
626123-0404-010	4.00	10.00	4.00	2.00
626123-0454-011	4.00	11.00	5.00	1.50
626123-0404-011	4.00	11.00	5.00	2.00
626123-0454-012	4.00	12.00	6.00	1.50
626123-0404-012	4.00	12.00	6.00	2.00
626123-0454-013	4.00	13.00	7.00	1.50
626123-0404-013	4.00	13.00	7.00	2.00
626123-0454-014	4.00	14.00	8.00	1.50
626123-0404-014	4.00	14.00	8.00	2.00
626123-0454-015	4.00	15.00	9.00	1.50
626123-0404-015	4.00	15.00	9.00	2.00
626123-0454-016	4.00	16.00	10.00	1.50
626123-0404-016	4.00	16.00	10.00	2.00
626123-0454-017	4.00	17.00	11.00	1.50
626123-0404-017	4.00	17.00	11.00	2.00
626123-0454-018	4.00	18.00	12.00	1.50
626123-0404-018	4.00	18.00	12.00	2.00
626123-0454-019	4.00	19.00	13.00	1.50
626123-0404-019	4.00	19.00	13.00	2.00
626123-0454-020	4.00	20.00	14.00	1.50
626123-0404-020	4.00	20.00	14.00	2.00
626123-0454-021	4.00	21.00	15.00	1.50
626123-0404-021	4.00	21.00	15.00	2.00



Article-No.	DK	L	ML	DS
626123-0454-022	4.00	22.00	16.00	1.50
626123-0404-022	4.00	22.00	16.00	2.00
626123-0454-023	4.00	23.00	17.00	1.50
626123-0404-023	4.00	23.00	17.00	2.00
626113-0402-023	4.00	23.00	16.00	2.50
626123-0454-024	4.00	24.00	18.00	1.50
626123-0404-024	4.00	24.00	18.00	2.00
626123-0454-025	4.00	25.00	19.00	1.50
626123-0404-025	4.00	25.00	19.00	2.00
626123-0454-026	4.00	26.00	20.00	1.50
626123-0404-026	4.00	26.00	20.00	2.00
626123-0454-027	4.00	27.00	21.00	1.50
626123-0404-027	4.00	27.00	21.00	2.00
626123-0454-028	4.00	28.00	22.00	1.50
626123-0404-028	4.00	28.00	22.00	2.00
626123-0454-029	4.00	29.00	23.00	1.50
626123-0404-029	4.00	29.00	23.00	2.00
626123-0454-030	4.00	30.00	24.00	1.50
626123-0404-030	4.00	30.00	24.00	2.00
626123-0454-031	4.00	31.00	25.00	1.50
626123-0404-031	4.00	31.00	25.00	2.00
000000-1086-808	4.00	32.00	25.00	2.50
626123-0454-032	4.00	32.00	26.00	1.50
626123-0404-032	4.00	32.00	26.00	2.00
626123-0454-033	4.00	33.00	27.00	1.50
626123-0404-033	4.00	33.00	27.00	2.00
626113-0400-033	4.00	33.00	25.00	2.50
626123-0454-034	4.00	34.00	28.00	1.50
626123-0404-034	4.00	34.00	28.00	2.00
626123-0454-035	4.00	35.00	29.00	1.50
626123-0404-035	4.00	35.00	29.00	2.00
626123-0454-036	4.00	36.00	30.00	1.50
626123-0404-036	4.00	36.00	30.00	2.00
626123-0454-037	4.00	37.00	31.00	1.50
626123-0404-037	4.00	37.00	31.00	2.00
626123-0454-038	4.00	38.00	32.00	1.50
626123-0404-038	4.00	38.00	32.00	2.00
626123-0454-039	4.00	39.00	33.00	1.50
626123-0404-039	4.00	39.00	33.00	2.00
626123-0454-040	4.00	40.00	34.00	1.50
626123-0404-040	4.00	40.00	34.00	2.00
626123-0454-041	4.00	41.00	35.00	1.50
626123-0404-041	4.00	41.00	35.00	2.00
626123-0454-042	4.00	42.00	36.00	1.50
626123-0404-042	4.00	42.00	36.00	2.00
626123-0454-043	4.00	43.00	37.00	1.50
626123-0404-043	4.00	43.00	37.00	2.00
626123-0454-044	4.00	44.00	38.00	1.50
626123-0404-044	4.00	44.00	38.00	2.00
626123-0454-045	4.00	45.00	39.00	1.50
626123-0404-045	4.00	45.00	39.00	2.00



Article-No.	DK	L	ML	DS
626123-0454-046	4.00	46.00	40.00	1.50
626123-0404-046	4.00	46.00	40.00	2.00
626123-0454-047	4.00	47.00	41.00	1.50
626123-0404-047	4.00	47.00	41.00	2.00
626123-0454-048	4.00	48.00	42.00	1.50
626123-0404-048	4.00	48.00	42.00	2.00
626123-0454-049	4.00	49.00	43.00	1.50
626123-0404-049	4.00	49.00	43.00	2.00
626123-0404-050	4.00	50.00	44.00	2.00
626123-0454-050	4.00	50.00	44.00	1.50
626113-0401-050	4.00	50.00	43.00	1.00
626123-0404-051	4.00	51.00	45.00	2.00
626123-0454-051	4.00	51.00	45.00	1.50
626123-0454-052	4.00	52.00	46.00	1.50
626123-0404-052	4.00	52.00	46.00	2.00
626123-0454-053	4.00	53.00	47.00	1.50
626123-0404-053	4.00	53.00	47.00	2.00
626123-0454-054	4.00	54.00	48.00	1.50
626123-0404-054	4.00	54.00	48.00	2.00
626123-0454-055	4.00	55.00	49.00	1.50
626123-0404-055	4.00	55.00	49.00	2.00
626123-0454-056	4.00	56.00	50.00	1.50
626123-0404-056	4.00	56.00	50.00	2.00
626123-0454-057	4.00	57.00	51.00	1.50
626123-0404-057	4.00	57.00	51.00	2.00
626123-0454-058	4.00	58.00	52.00	1.50
626123-0404-058	4.00	58.00	52.00	2.00
626123-0454-059	4.00	59.00	53.00	1.50
626123-0404-059	4.00	59.00	53.00	2.00
626123-0454-060	4.00	60.00	54.00	1.50
626123-0404-060	4.00	60.00	54.00	2.00
626123-0404-061	4.00	61.00	55.00	2.00
626123-0404-062	4.00	62.00	56.00	2.00
626123-0404-063	4.00	63.00	57.00	2.00
626123-0404-064	4.00	64.00	58.00	2.00
626123-0404-065	4.00	65.00	59.00	2.00
626123-0404-066	4.00	66.00	60.00	2.00
626123-0404-067	4.00	67.00	61.00	2.00
626123-0404-068	4.00	68.00	62.00	2.00
626123-0404-069	4.00	69.00	63.00	2.00
626123-0404-070	4.00	70.00	64.00	2.00
626123-0404-071	4.00	71.00	65.00	2.00
626123-0404-072	4.00	72.00	66.00	2.00
626123-0404-073	4.00	73.00	67.00	2.00
626123-0404-074	4.00	74.00	68.00	2.00
626123-0404-075	4.00	75.00	69.00	2.00
626123-0404-076	4.00	76.00	70.00	2.00
626123-0404-077	4.00	77.00	71.00	2.00
626123-0404-078	4.00	78.00	72.00	2.00
626123-0404-079	4.00	79.00	73.00	2.00
626123-0404-080	4.00	80.00	74.00	2.00
626123-0404-081	4.00	81.00	75.00	2.00
626123-0404-082	4.00	82.00	76.00	2.00
626113-0400-083	4.00	83.00	70.00	3.00



Article-No.	DK	L	ML	DS
626123-0404-083	4.00	83.00	77.00	2.00
626123-0404-084	4.00	84.00	78.00	2.00
626123-0404-085	4.00	85.00	79.00	2.00
626123-0404-086	4.00	86.00	80.00	2.00
626123-0404-087	4.00	87.00	81.00	2.00
626123-0404-088	4.00	88.00	82.00	2.00
626123-0404-089	4.00	89.00	83.00	2.00
626123-0404-090	4.00	90.00	84.00	2.00
626123-0404-091	4.00	91.00	85.00	2.00
626123-0404-092	4.00	92.00	86.00	2.00
626123-0404-093	4.00	93.00	87.00	2.00
626123-0404-094	4.00	94.00	88.00	2.00
626123-0404-095	4.00	95.00	89.00	2.00
626123-0404-096	4.00	96.00	90.00	2.00
626123-0404-097	4.00	97.00	91.00	2.00
626123-0404-098	4.00	98.00	92.00	2.00
626123-0404-099	4.00	99.00	93.00	2.00
626123-0404-100	4.00	100.00	94.00	2.00
626123-0404-101	4.00	101.00	95.00	2.00
626123-0404-102	4.00	102.00	96.00	2.00
626123-0404-103	4.00	103.00	97.00	2.00
626123-0404-104	4.00	104.00	98.00	2.00
626123-0404-105	4.00	105.00	99.00	2.00
626123-0404-106	4.00	106.00	100.00	2.00
626123-0404-107	4.00	107.00	101.00	2.00
626123-0404-108	4.00	108.00	102.00	2.00
626123-0404-109	4.00	109.00	103.00	2.00
626123-0404-110	4.00	110.00	104.00	2.00
626123-0404-111	4.00	111.00	105.00	2.00
626123-0404-112	4.00	112.00	106.00	2.00
626123-0404-113	4.00	113.00	107.00	2.00
626123-0404-114	4.00	114.00	108.00	2.00
626123-0404-115	4.00	115.00	109.00	2.00
626123-0404-116	4.00	116.00	110.00	2.00
626123-0404-117	4.00	117.00	111.00	2.00
626123-0404-118	4.00	118.00	112.00	2.00
626123-0404-119	4.00	119.00	113.00	2.00
626123-0404-120	4.00	120.00	114.00	2.00
626123-0404-121	4.00	121.00	115.00	2.00
626123-0404-122	4.00	122.00	116.00	2.00
626123-0404-123	4.00	123.00	117.00	2.00
626123-0404-124	4.00	124.00	118.00	2.00
626123-0404-125	4.00	125.00	119.00	2.00
626113-0450-011	4.50	10.50	4.50	2.00
626123-0504-011	5.00	11.00	5.00	2.00
626123-0504-012	5.00	12.00	6.00	2.00
626113-0500-013	5.00	12.50	6.50	2.00
626123-0504-013	5.00	13.00	7.00	2.00
626123-0504-014	5.00	14.00	8.00	2.00
626123-0504-015	5.00	15.00	9.00	2.00
626123-0504-016	5.00	16.00	10.00	2.00



Article-No.	DK	L	ML	DS
626123-0504-017	5.00	17.00	11.00	2.00
626123-0504-018	5.00	18.00	12.00	2.00
626123-0504-019	5.00	19.00	13.00	2.00
626123-0504-020	5.00	20.00	14.00	2.00
626123-0504-021	5.00	21.00	15.00	2.00
626123-0504-022	5.00	22.00	16.00	2.00
626123-0504-023	5.00	23.00	17.00	2.00
626123-0504-024	5.00	24.00	18.00	2.00
626123-0504-025	5.00	25.00	19.00	2.00
626123-0504-026	5.00	26.00	20.00	2.00
626123-0504-027	5.00	27.00	21.00	2.00
626123-0504-028	5.00	28.00	22.00	2.00
626123-0504-029	5.00	29.00	23.00	2.00
626123-0504-030	5.00	30.00	24.00	2.00
626123-0504-031	5.00	31.00	25.00	2.00
626123-0504-032	5.00	32.00	26.00	2.00
626123-0504-033	5.00	33.00	27.00	2.00
626123-0504-034	5.00	34.00	28.00	2.00
626123-0504-035	5.00	35.00	29.00	2.00
626123-0504-036	5.00	36.00	30.00	2.00
626123-0504-037	5.00	37.00	31.00	2.00
626123-0504-038	5.00	38.00	32.00	2.00
626123-0504-039	5.00	39.00	33.00	2.00
626123-0504-040	5.00	40.00	34.00	2.00
626123-0504-041	5.00	41.00	35.00	2.00
626123-0504-042	5.00	42.00	36.00	2.00
626123-0504-043	5.00	43.00	37.00	2.00
626123-0504-044	5.00	44.00	38.00	2.00
626123-0504-045	5.00	45.00	39.00	2.00
626123-0504-046	5.00	46.00	40.00	2.00
626123-0504-047	5.00	47.00	41.00	2.00
626123-0504-048	5.00	48.00	42.00	2.00
626123-0504-049	5.00	49.00	43.00	2.00
626123-0504-050	5.00	50.00	44.00	2.00
626123-0504-051	5.00	51.00	45.00	2.00
626123-0504-052	5.00	52.00	46.00	2.00
626123-0504-053	5.00	53.00	47.00	2.00
626123-0504-054	5.00	54.00	48.00	2.00
626123-0504-055	5.00	55.00	49.00	2.00
626123-0504-056	5.00	56.00	50.00	2.00
626123-0504-057	5.00	57.00	51.00	2.00
626123-0504-058	5.00	58.00	52.00	2.00
626123-0504-059	5.00	59.00	53.00	2.00
626123-0504-060	5.00	60.00	54.00	2.00
626123-0504-061	5.00	61.00	55.00	2.00
626123-0504-062	5.00	62.00	56.00	2.00
626123-0504-063	5.00	63.00	57.00	2.00
626123-0504-064	5.00	64.00	58.00	2.00
626123-0504-065	5.00	65.00	59.00	2.00
626123-0504-066	5.00	66.00	60.00	2.00
626123-0504-067	5.00	67.00	61.00	2.00
626123-0504-068	5.00	68.00	62.00	2.00
626123-0504-069	5.00	69.00	63.00	2.00
626123-0504-070	5.00	70.00	64.00	2.00



Article-No.	DK	L	ML	DS
626123-0504-071	5.00	71.00	65.00	2.00
626123-0504-072	5.00	72.00	66.00	2.00
626123-0504-073	5.00	73.00	67.00	2.00
626123-0504-074	5.00	74.00	68.00	2.00
626123-0504-075	5.00	75.00	69.00	2.00
626123-0504-076	5.00	76.00	70.00	2.00
626123-0504-077	5.00	77.00	71.00	2.00
626123-0504-078	5.00	78.00	72.00	2.00
626123-0504-079	5.00	79.00	73.00	2.00
626123-0504-080	5.00	80.00	74.00	2.00
626123-0504-081	5.00	81.00	75.00	2.00
626123-0504-082	5.00	82.00	76.00	2.00
626123-0504-083	5.00	83.00	77.00	2.00
626123-0504-084	5.00	84.00	78.00	2.00
626123-0504-085	5.00	85.00	79.00	2.00
626123-0504-086	5.00	86.00	80.00	2.00
626123-0504-087	5.00	87.00	81.00	2.00
626123-0504-088	5.00	88.00	82.00	2.00
626123-0504-089	5.00	89.00	83.00	2.00
626123-0504-090	5.00	90.00	84.00	2.00
626123-0504-091	5.00	91.00	85.00	2.00
626123-0504-092	5.00	92.00	86.00	2.00
626123-0504-093	5.00	93.00	87.00	2.00
626123-0504-094	5.00	94.00	88.00	2.00
626123-0504-095	5.00	95.00	89.00	2.00
626123-0504-096	5.00	96.00	90.00	2.00
626123-0504-097	5.00	97.00	91.00	2.00
626123-0504-098	5.00	98.00	92.00	2.00
626123-0504-099	5.00	99.00	93.00	2.00
626123-0504-100	5.00	100.00	94.00	2.00
626113-0501-100	5.00	100.00	90.00	2.00
626123-0504-101	5.00	101.00	95.00	2.00
626123-0504-102	5.00	102.00	96.00	2.00
626123-0504-103	5.00	103.00	97.00	2.00
626123-0504-104	5.00	104.00	98.00	2.00
626123-0504-105	5.00	105.00	99.00	2.00
626123-0504-106	5.00	106.00	100.00	2.00
626123-0504-107	5.00	107.00	101.00	2.00
626123-0504-108	5.00	108.00	102.00	2.00
626123-0504-109	5.00	109.00	103.00	2.00
626123-0504-110	5.00	110.00	104.00	2.00
626123-0504-111	5.00	111.00	105.00	2.00
626123-0504-112	5.00	112.00	106.00	2.00
626123-0504-113	5.00	113.00	107.00	2.00
626123-0504-114	5.00	114.00	108.00	2.00
626123-0504-115	5.00	115.00	109.00	2.00
626123-0504-116	5.00	116.00	110.00	2.00
626123-0504-117	5.00	117.00	111.00	2.00
626123-0504-118	5.00	118.00	112.00	2.00
626123-0504-119	5.00	119.00	113.00	2.00
626123-0504-120	5.00	120.00	114.00	2.00





Article-No.	DK	L	ML	DS
626123-0504-121	5.00	121.00	115.00	2.00
626123-0504-122	5.00	122.00	116.00	2.00
626123-0504-123	5.00	123.00	117.00	2.00
626123-0504-124	5.00	124.00	118.00	2.00
626123-0504-125	5.00	125.00	119.00	2.00
626113-0600-028	6.00	28.00	18.00	2.00
626113-0601-050	6.00	50.00	40.00	2.00
626113-0600-050	6.00	50.00	40.00	2.00
626113-0600-053	6.00	53.00	47.00	2.00
626113-0650-053	6.50	53.00	46.00	2.00
626113-0800-029	8.00	29.00	20.00	3.00
626113-0800-073	8.00	73.00	69.00	3.00
626113-0800-082	8.00	82.00	75.00	2.00
000000-1209-349	10.00	34.50	27.50	2.00

### M3 REN, Styli straight, ruby sphere, ceramic shaft

Standard Styli suitable for all common measuring tasks. M3 thread for ZEISS RST, Renishaw SP and Hexagon HP-S sensors.

Not for ZEISS VAST XXT sensors (see product notes).

Connection Type: M3  
 Shaft Material: Ceramic  
 Stylus Tip Geometry: Sphere  
 Stylus Tip Material: Ruby  
 Ø Body (DG): 4

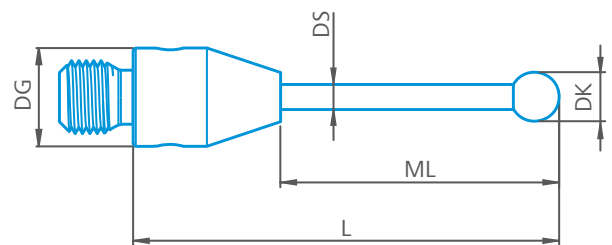

Article-No.	DK	L	ML	DS
626113-0302-052	3.00	51.50	44.50	2.00
626113-0300-052	3.00	51.50	44.50	1.50
626120-0159-000	3.00	51.50	33.70	2.00
602030-8102-000	4.00	32.00	24.00	2.00
626120-0158-000	4.00	52.00	52.00	2.00
602030-8101-000	5.00	32.50	24.50	2.00
626113-0500-033	5.00	32.50	24.50	2.00
626120-0157-000	5.00	52.50	52.50	2.50
602030-8020-000	6.00	13.00	9.00	2.00
626113-0601-040	6.00	40.00	30.00	3.00
626113-0801-021	8.00	21.00	13.00	2.00
626113-0800-045	8.00	45.00	35.00	3.00

### M3 REN, Styli straight, ruby sphere, carbon fibre shaft

Standard Styli suitable for all common measuring tasks. M3 thread for ZEISS RST, Renishaw SP and Hexagon HP-S sensors.

Not for ZEISS VAST XXT sensors (see product notes).

Connection Type: M3  
 Shaft Material: Carbon Fiber  
 Stylus Tip Geometry: Sphere  
 Stylus Tip Material: Ruby  
 Ø Body (DG): 4

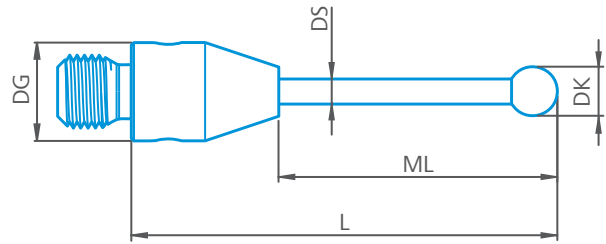

Article-No.	DK	L	ML	DS
626113-0300-083	3.00	83.00	76.00	2.00
626120-0295-000	8.00	79.00	79.00	4.00
626120-0155-000	8.00	104.00	104.00	4.00

### M3 REN, Styli straight, silicon nitride sphere, tungsten carbide shaft

Standard Styli suitable for all common measuring tasks. M3 thread for ZEISS RST, Renishaw SP and Hexagon HP-S sensors.

Not for ZEISS VAST XXT sensors (see product notes).

Connection Type: M3  
 Shaft Material: Tung. Carb.  
 Stylus Tip Geometry: Sphere  
 Stylus Tip Material: Si. Nitride  
 Ø Body (DG): 4

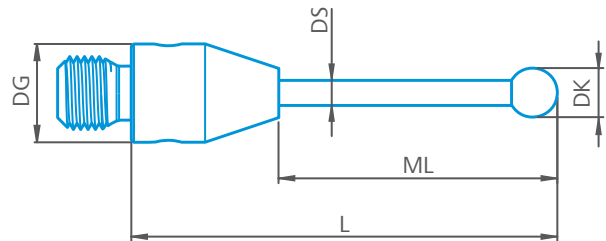

Article-No.	DK	L	ML	DS
626123-5745-009	1.35	9.00	3.00	1.00
626123-5745-010	1.35	10.00	4.00	1.00
626123-5745-011	1.35	11.00	5.00	1.00
626123-5745-012	1.35	12.00	6.00	1.00
626123-5745-013	1.35	13.00	7.00	1.00
626123-5745-014	1.35	14.00	8.00	1.00
626123-5745-015	1.35	15.00	9.00	1.00
626123-5745-016	1.35	16.00	10.00	1.00
626123-5745-017	1.35	17.00	11.00	1.00
626123-5745-018	1.35	18.00	12.00	1.00
626123-5745-019	1.35	19.00	13.00	1.00
626123-5745-020	1.35	20.00	14.00	1.00
626123-5745-021	1.35	21.00	15.00	1.00
626123-5745-022	1.35	22.00	16.00	1.00
626123-5745-023	1.35	23.00	17.00	1.00
626123-5745-024	1.35	24.00	18.00	1.00
626123-5745-025	1.35	25.00	19.00	1.00



Article-No.	DK	L	ML	DS
626123-5745-026	1.35	26.00	20.00	1.00
626123-5745-027	1.35	27.00	21.00	1.00
626123-5745-028	1.35	28.00	22.00	1.00
626123-5745-029	1.35	29.00	23.00	1.00
626123-5745-030	1.35	30.00	24.00	1.00
626123-5745-031	1.35	31.00	25.00	1.00
626123-5745-032	1.35	32.00	26.00	1.00
626123-5745-033	1.35	33.00	27.00	1.00
626123-5745-034	1.35	34.00	28.00	1.00
626123-5745-035	1.35	35.00	29.00	1.00
626123-5745-036	1.35	36.00	30.00	1.00
626123-5745-037	1.35	37.00	31.00	1.00
626123-5745-038	1.35	38.00	32.00	1.00
626123-5745-039	1.35	39.00	33.00	1.00
626123-5745-040	1.35	40.00	34.00	1.00
626123-5745-041	1.35	41.00	35.00	1.00
626123-5745-042	1.35	42.00	36.00	1.00
626123-5745-043	1.35	43.00	37.00	1.00
626123-5745-044	1.35	44.00	38.00	1.00
626123-5745-045	1.35	45.00	39.00	1.00
626123-0145-009	1.50	9.00	3.00	1.00
626123-0145-010	1.50	10.00	4.00	1.00
626123-0145-011	1.50	11.00	5.00	1.00
626123-0145-012	1.50	12.00	6.00	1.00
626123-0145-013	1.50	13.00	7.00	1.00
626123-0145-014	1.50	14.00	8.00	1.00
626123-0145-015	1.50	15.00	9.00	1.00
626123-0145-016	1.50	16.00	10.00	1.00
626123-0145-017	1.50	17.00	11.00	1.00
626123-0145-018	1.50	18.00	12.00	1.00
626123-0145-019	1.50	19.00	13.00	1.00
626123-0145-020	1.50	20.00	14.00	1.00
626123-0145-021	1.50	21.00	15.00	1.00
626123-0145-022	1.50	22.00	16.00	1.00
626123-0145-023	1.50	23.00	17.00	1.00
626123-0145-024	1.50	24.00	18.00	1.00
626123-0145-025	1.50	25.00	19.00	1.00
626123-0145-026	1.50	26.00	20.00	1.00
626123-0145-027	1.50	27.00	21.00	1.00
626123-0145-028	1.50	28.00	22.00	1.00
626123-0145-029	1.50	29.00	23.00	1.00
626123-0145-030	1.50	30.00	24.00	1.00
626113-0152-030	1.50	30.00	23.00	1.00
626123-0145-031	1.50	31.00	25.00	1.00
626123-0145-032	1.50	32.00	26.00	1.00
626123-0145-033	1.50	33.00	27.00	1.00
626123-0145-034	1.50	34.00	28.00	1.00
626123-0145-035	1.50	35.00	29.00	1.00
626123-0145-036	1.50	36.00	30.00	1.00
626123-0145-037	1.50	37.00	31.00	1.00
626123-0145-038	1.50	38.00	32.00	1.00
626123-0145-039	1.50	39.00	33.00	1.00
626123-0145-040	1.50	40.00	34.00	1.00
626123-0145-041	1.50	41.00	35.00	1.00



Article-No.	DK	L	ML	DS
626123-0145-042	1.50	42.00	36.00	1.00
626123-0145-043	1.50	43.00	37.00	1.00
626123-0145-044	1.50	44.00	38.00	1.00
626123-0145-045	1.50	45.00	39.00	1.00
626113-0150-060	1.50	60.00	53.00	1.00
626123-0255-009	2.00	9.00	3.00	1.50
626123-0245-009	2.00	9.00	3.00	1.00
626123-0255-010	2.00	10.00	4.00	1.50
626123-0245-010	2.00	10.00	4.00	1.00
626123-0255-011	2.00	11.00	5.00	1.50
626123-0245-011	2.00	11.00	5.00	1.00
626123-0255-012	2.00	12.00	6.00	1.50
626123-0245-012	2.00	12.00	6.00	1.00
626123-0255-013	2.00	13.00	7.00	1.50
626123-0245-013	2.00	13.00	7.00	1.00
626123-0255-014	2.00	14.00	8.00	1.50
626123-0245-014	2.00	14.00	8.00	1.00
626123-0255-015	2.00	15.00	9.00	1.50
626123-0245-015	2.00	15.00	9.00	1.00
626123-0255-016	2.00	16.00	10.00	1.50
626123-0245-016	2.00	16.00	10.00	1.00
626123-0255-017	2.00	17.00	11.00	1.50
626123-0245-017	2.00	17.00	11.00	1.00
626123-0255-018	2.00	18.00	12.00	1.50
626123-0245-018	2.00	18.00	12.00	1.00
626123-0255-019	2.00	19.00	13.00	1.50
626123-0245-019	2.00	19.00	13.00	1.00
626123-0255-020	2.00	20.00	14.00	1.50
626123-0245-020	2.00	20.00	14.00	1.00
626123-0255-021	2.00	21.00	15.00	1.50
626123-0245-021	2.00	21.00	15.00	1.00
626123-0255-022	2.00	22.00	16.00	1.50
626123-0245-022	2.00	22.00	16.00	1.00
626123-0255-023	2.00	23.00	17.00	1.50
626123-0245-023	2.00	23.00	17.00	1.00
626123-0255-024	2.00	24.00	18.00	1.50
626123-0245-024	2.00	24.00	18.00	1.00
626123-0255-025	2.00	25.00	19.00	1.50
626123-0245-025	2.00	25.00	19.00	1.00
626123-0255-026	2.00	26.00	20.00	1.50
626123-0245-026	2.00	26.00	20.00	1.00
626123-0255-027	2.00	27.00	21.00	1.50
626123-0245-027	2.00	27.00	21.00	1.00
626123-0255-028	2.00	28.00	22.00	1.50
626123-0245-028	2.00	28.00	22.00	1.00
626123-0255-029	2.00	29.00	23.00	1.50
626123-0245-029	2.00	29.00	23.00	1.00
626123-0255-030	2.00	30.00	24.00	1.50
626123-0245-030	2.00	30.00	24.00	1.00
626123-0255-031	2.00	31.00	25.00	1.50
626123-0245-031	2.00	31.00	25.00	1.00



Article-No.	DK	L	ML	DS
626123-0255-032	2.00	32.00	26.00	1.50
626123-0245-032	2.00	32.00	26.00	1.00
626123-0255-033	2.00	33.00	27.00	1.50
626123-0245-033	2.00	33.00	27.00	1.00
626123-0255-034	2.00	34.00	28.00	1.50
626123-0245-034	2.00	34.00	28.00	1.00
626123-0255-035	2.00	35.00	29.00	1.50
626123-0245-035	2.00	35.00	29.00	1.00
626123-0255-036	2.00	36.00	30.00	1.50
626123-0245-036	2.00	36.00	30.00	1.00
626123-0255-037	2.00	37.00	31.00	1.50
626123-0245-037	2.00	37.00	31.00	1.00
626123-0255-038	2.00	38.00	32.00	1.50
626123-0245-038	2.00	38.00	32.00	1.00
626123-0245-039	2.00	39.00	33.00	1.00
626123-0255-039	2.00	39.00	33.00	1.50
626123-0255-040	2.00	40.00	34.00	1.50
626123-0245-040	2.00	40.00	34.00	1.00
626123-0245-041	2.00	41.00	35.00	1.00
626123-0255-041	2.00	41.00	35.00	1.50
626123-0245-042	2.00	42.00	36.00	1.00
626123-0255-042	2.00	42.00	36.00	1.50
626123-0255-043	2.00	43.00	37.00	1.50
626123-0245-043	2.00	43.00	37.00	1.00
626123-0255-044	2.00	44.00	38.00	1.50
626123-0245-044	2.00	44.00	38.00	1.00
626123-0255-045	2.00	45.00	39.00	1.50
626123-0245-045	2.00	45.00	39.00	1.00
626123-0255-046	2.00	46.00	40.00	1.50
626123-0255-047	2.00	47.00	41.00	1.50
626123-0255-048	2.00	48.00	42.00	1.50
626123-0255-049	2.00	49.00	43.00	1.50
626123-0255-050	2.00	50.00	44.00	1.50
626123-0255-051	2.00	51.00	45.00	1.50
626123-0255-052	2.00	52.00	46.00	1.50
626123-0255-053	2.00	53.00	47.00	1.50
626123-0255-054	2.00	54.00	48.00	1.50
626123-0255-055	2.00	55.00	49.00	1.50
626123-0255-056	2.00	56.00	50.00	1.50
626123-0255-057	2.00	57.00	51.00	1.50
626123-0255-058	2.00	58.00	52.00	1.50
626123-0255-059	2.00	59.00	53.00	1.50
626123-0255-060	2.00	60.00	54.00	1.50
626123-5855-009	2.50	9.00	3.00	1.50
626123-5855-010	2.50	10.00	4.00	1.50
626123-5855-011	2.50	11.00	5.00	1.50
626123-5855-012	2.50	12.00	6.00	1.50
626123-5855-013	2.50	13.00	7.00	1.50
626123-5855-014	2.50	14.00	8.00	1.50
626123-5855-015	2.50	15.00	9.00	1.50
626123-5855-016	2.50	16.00	10.00	1.50
626123-5855-017	2.50	17.00	11.00	1.50
626123-5855-018	2.50	18.00	12.00	1.50
626123-5855-019	2.50	19.00	13.00	1.50



Article-No.	DK	L	ML	DS
626123-5855-020	2.50	20.00	14.00	1.50
626123-5855-021	2.50	21.00	15.00	1.50
626123-5855-022	2.50	22.00	16.00	1.50
626123-5855-023	2.50	23.00	17.00	1.50
626123-5855-024	2.50	24.00	18.00	1.50
626123-5855-025	2.50	25.00	19.00	1.50
626123-5855-026	2.50	26.00	20.00	1.50
626123-5855-027	2.50	27.00	21.00	1.50
626123-5855-028	2.50	28.00	22.00	1.50
626123-5855-029	2.50	29.00	23.00	1.50
626123-5855-030	2.50	30.00	24.00	1.50
626123-5855-031	2.50	31.00	25.00	1.50
626123-5855-032	2.50	32.00	26.00	1.50
626123-5855-033	2.50	33.00	27.00	1.50
626123-5855-034	2.50	34.00	28.00	1.50
626123-5855-035	2.50	35.00	29.00	1.50
626123-5855-036	2.50	36.00	30.00	1.50
626123-5855-037	2.50	37.00	31.00	1.50
626123-5855-038	2.50	38.00	32.00	1.50
626123-5855-039	2.50	39.00	33.00	1.50
626123-5855-040	2.50	40.00	34.00	1.50
626123-5855-041	2.50	41.00	35.00	1.50
626123-5855-042	2.50	42.00	36.00	1.50
626123-5855-043	2.50	43.00	37.00	1.50
626123-5855-044	2.50	44.00	38.00	1.50
626123-5855-045	2.50	45.00	39.00	1.50
626123-5855-046	2.50	46.00	40.00	1.50
626123-5855-047	2.50	47.00	41.00	1.50
626123-5855-048	2.50	48.00	42.00	1.50
626123-5855-049	2.50	49.00	43.00	1.50
626123-5855-050	2.50	50.00	44.00	1.50
626123-5855-051	2.50	51.00	45.00	1.50
626123-5855-052	2.50	52.00	46.00	1.50
626123-5855-053	2.50	53.00	47.00	1.50
626123-5855-054	2.50	54.00	48.00	1.50
626123-5855-055	2.50	55.00	49.00	1.50
626123-5855-056	2.50	56.00	50.00	1.50
626123-5855-057	2.50	57.00	51.00	1.50
626123-5855-058	2.50	58.00	52.00	1.50
626123-5855-059	2.50	59.00	53.00	1.50
626123-5855-060	2.50	60.00	54.00	1.50
626123-0305-009	3.00	9.00	3.00	2.00
626123-0355-009	3.00	9.00	3.00	1.50
626123-0305-010	3.00	10.00	4.00	2.00
626123-0355-010	3.00	10.00	4.00	1.50
626123-0305-011	3.00	11.00	5.00	2.00
626123-0355-011	3.00	11.00	5.00	1.50
626123-0305-012	3.00	12.00	6.00	2.00
626123-0355-012	3.00	12.00	6.00	1.50
626123-0305-013	3.00	13.00	7.00	2.00
626123-0355-013	3.00	13.00	7.00	1.50



Article-No.	DK	L	ML	DS
626123-0305-014	3.00	14.00	8.00	2.00
626123-0355-014	3.00	14.00	8.00	1.50
626123-0305-015	3.00	15.00	9.00	2.00
626123-0355-015	3.00	15.00	9.00	1.50
626123-0305-016	3.00	16.00	10.00	2.00
626123-0355-016	3.00	16.00	10.00	1.50
626123-0305-017	3.00	17.00	11.00	2.00
626123-0355-017	3.00	17.00	11.00	1.50
626123-0305-018	3.00	18.00	12.00	2.00
626123-0355-018	3.00	18.00	12.00	1.50
626123-0305-019	3.00	19.00	13.00	2.00
626123-0355-019	3.00	19.00	13.00	1.50
626123-0305-020	3.00	20.00	14.00	2.00
626123-0355-020	3.00	20.00	14.00	1.50
626123-0305-021	3.00	21.00	15.00	2.00
626123-0355-021	3.00	21.00	15.00	1.50
626113-0302-022	3.00	21.50	15.50	1.50
626123-0305-022	3.00	22.00	16.00	2.00
626123-0355-022	3.00	22.00	16.00	1.50
626123-0305-023	3.00	23.00	17.00	2.00
626123-0355-023	3.00	23.00	17.00	1.50
626123-0305-024	3.00	24.00	18.00	2.00
626123-0355-024	3.00	24.00	18.00	1.50
626123-0305-025	3.00	25.00	19.00	2.00
626123-0355-025	3.00	25.00	19.00	1.50
626123-0305-026	3.00	26.00	20.00	2.00
626123-0355-026	3.00	26.00	20.00	1.50
626123-0305-027	3.00	27.00	21.00	2.00
626123-0355-027	3.00	27.00	21.00	1.50
626123-0305-028	3.00	28.00	22.00	2.00
626123-0355-028	3.00	28.00	22.00	1.50
626123-0305-029	3.00	29.00	23.00	2.00
626123-0355-029	3.00	29.00	23.00	1.50
626123-0305-030	3.00	30.00	24.00	2.00
626123-0355-030	3.00	30.00	24.00	1.50
626123-0305-031	3.00	31.00	25.00	2.00
626123-0355-031	3.00	31.00	25.00	1.50
626123-0305-032	3.00	32.00	26.00	2.00
626123-0355-032	3.00	32.00	26.00	1.50
626123-0305-033	3.00	33.00	27.00	2.00
626123-0355-033	3.00	33.00	27.00	1.50
626123-0305-034	3.00	34.00	28.00	2.00
626123-0355-034	3.00	34.00	28.00	1.50
626123-0305-035	3.00	35.00	29.00	2.00
626123-0355-035	3.00	35.00	29.00	1.50
626123-0305-036	3.00	36.00	30.00	2.00
626123-0355-036	3.00	36.00	30.00	1.50
626123-0305-037	3.00	37.00	31.00	2.00
626123-0355-037	3.00	37.00	31.00	1.50
626123-0305-038	3.00	38.00	32.00	2.00
626123-0355-038	3.00	38.00	32.00	1.50
626123-0305-039	3.00	39.00	33.00	2.00
626123-0355-039	3.00	39.00	33.00	1.50
626123-0305-040	3.00	40.00	34.00	2.00



Article-No.	DK	L	ML	DS
626123-0355-040	3.00	40.00	34.00	1.50
626123-0305-041	3.00	41.00	35.00	2.00
626123-0355-041	3.00	41.00	35.00	1.50
626123-0305-042	3.00	42.00	36.00	2.00
626123-0355-042	3.00	42.00	36.00	1.50
626123-0305-043	3.00	43.00	37.00	2.00
626123-0355-043	3.00	43.00	37.00	1.50
626123-0305-044	3.00	44.00	38.00	2.00
626123-0355-044	3.00	44.00	38.00	1.50
626123-0305-045	3.00	45.00	39.00	2.00
626123-0355-045	3.00	45.00	39.00	1.50
626123-0305-046	3.00	46.00	40.00	2.00
626123-0305-047	3.00	47.00	41.00	2.00
626123-0305-048	3.00	48.00	42.00	2.00
626123-0305-049	3.00	49.00	43.00	2.00
626123-0305-050	3.00	50.00	44.00	2.00
626113-0310-050	3.00	50.00	44.00	1.50
626123-0305-051	3.00	51.00	45.00	2.00
626113-0301-052	3.00	51.50	45.50	2.00
626123-0305-052	3.00	52.00	46.00	2.00
626123-0305-053	3.00	53.00	47.00	2.00
626123-0305-054	3.00	54.00	48.00	2.00
626123-0305-055	3.00	55.00	49.00	2.00
626123-0305-056	3.00	56.00	50.00	2.00
626113-0301-057	3.00	56.50	50.00	2.00
626123-0305-057	3.00	57.00	51.00	2.00
626123-0305-058	3.00	58.00	52.00	2.00
626123-0305-059	3.00	59.00	53.00	2.00
626123-0305-060	3.00	60.00	54.00	2.00
626123-0305-061	3.00	61.00	55.00	2.00
626123-0305-062	3.00	62.00	56.00	2.00
626123-0305-063	3.00	63.00	57.00	2.00
626123-0305-064	3.00	64.00	58.00	2.00
626123-0305-065	3.00	65.00	59.00	2.00
626123-0305-066	3.00	66.00	60.00	2.00
626123-0305-067	3.00	67.00	61.00	2.00
626123-0305-068	3.00	68.00	62.00	2.00
626123-0305-069	3.00	69.00	63.00	2.00
626123-0305-070	3.00	70.00	64.00	2.00
626123-0305-071	3.00	71.00	65.00	2.00
626123-0305-072	3.00	72.00	66.00	2.00
626123-0305-073	3.00	73.00	67.00	2.00
626123-0305-074	3.00	74.00	68.00	2.00
626123-0305-075	3.00	75.00	69.00	2.00
626123-0305-076	3.00	76.00	70.00	2.00
626123-0305-077	3.00	77.00	71.00	2.00
626123-0305-078	3.00	78.00	72.00	2.00
626123-0305-079	3.00	79.00	73.00	2.00
626123-0305-080	3.00	80.00	74.00	2.00
626123-0305-081	3.00	81.00	75.00	2.00
626123-0305-082	3.00	82.00	76.00	2.00





Article-No.	DK	L	ML	DS
626123-0305-083	3.00	83.00	77.00	2.00
626123-0305-084	3.00	84.00	78.00	2.00
626123-0305-085	3.00	85.00	79.00	2.00
626123-0305-086	3.00	86.00	80.00	2.00
626123-0305-087	3.00	87.00	81.00	2.00
626123-0305-088	3.00	88.00	82.00	2.00
626123-0305-089	3.00	89.00	83.00	2.00
626123-0305-090	3.00	90.00	84.00	2.00
626123-0305-091	3.00	91.00	85.00	2.00
626123-0305-092	3.00	92.00	86.00	2.00
626123-0305-093	3.00	93.00	87.00	2.00
626123-0305-094	3.00	94.00	88.00	2.00
626123-0305-095	3.00	95.00	89.00	2.00
626123-0455-009	4.00	9.00	3.00	1.50
626123-0405-010	4.00	10.00	4.00	2.00
626123-0455-010	4.00	10.00	4.00	1.50
626123-0405-011	4.00	11.00	5.00	2.00
626123-0455-011	4.00	11.00	5.00	1.50
626123-0405-012	4.00	12.00	6.00	2.00
626123-0455-012	4.00	12.00	6.00	1.50
626123-0405-013	4.00	13.00	7.00	2.00
626123-0455-013	4.00	13.00	7.00	1.50
626123-0405-014	4.00	14.00	8.00	2.00
626123-0455-014	4.00	14.00	8.00	1.50
626123-0405-015	4.00	15.00	9.00	2.00
626123-0455-015	4.00	15.00	9.00	1.50
626123-0405-016	4.00	16.00	10.00	2.00
626123-0455-016	4.00	16.00	10.00	1.50
626123-0405-017	4.00	17.00	11.00	2.00
626123-0455-017	4.00	17.00	11.00	1.50
626123-0405-018	4.00	18.00	12.00	2.00
626123-0455-018	4.00	18.00	12.00	1.50
626123-0405-019	4.00	19.00	13.00	2.00
626123-0455-019	4.00	19.00	13.00	1.50
626123-0405-020	4.00	20.00	14.00	2.00
626123-0455-020	4.00	20.00	14.00	1.50
626123-0405-021	4.00	21.00	15.00	2.00
626123-0455-021	4.00	21.00	15.00	1.50
626123-0405-022	4.00	22.00	16.00	2.00
626123-0455-022	4.00	22.00	16.00	1.50
626123-0405-023	4.00	23.00	17.00	2.00
626123-0455-023	4.00	23.00	17.00	1.50
626123-0405-024	4.00	24.00	18.00	2.00
626123-0455-024	4.00	24.00	18.00	1.50
626123-0405-025	4.00	25.00	19.00	2.00
626123-0455-025	4.00	25.00	19.00	1.50
626123-0405-026	4.00	26.00	20.00	2.00
626123-0455-026	4.00	26.00	20.00	1.50
626123-0405-027	4.00	27.00	21.00	2.00
626123-0455-027	4.00	27.00	21.00	1.50
626123-0405-028	4.00	28.00	22.00	2.00
626123-0455-028	4.00	28.00	22.00	1.50
626123-0405-029	4.00	29.00	23.00	2.00
626123-0455-029	4.00	29.00	23.00	1.50



Article-No.	DK	L	ML	DS
626123-0405-030	4.00	30.00	24.00	2.00
626123-0455-030	4.00	30.00	24.00	1.50
626123-0405-031	4.00	31.00	25.00	2.00
626123-0455-031	4.00	31.00	25.00	1.50
626123-0405-032	4.00	32.00	26.00	2.00
626123-0455-032	4.00	32.00	26.00	1.50
626123-0405-033	4.00	33.00	27.00	2.00
626123-0455-033	4.00	33.00	27.00	1.50
626123-0405-034	4.00	34.00	28.00	2.00
626123-0455-034	4.00	34.00	28.00	1.50
626123-0405-035	4.00	35.00	29.00	2.00
626123-0455-035	4.00	35.00	29.00	1.50
626123-0405-036	4.00	36.00	30.00	2.00
626123-0455-036	4.00	36.00	30.00	1.50
626123-0405-037	4.00	37.00	31.00	2.00
626123-0455-037	4.00	37.00	31.00	1.50
626123-0405-038	4.00	38.00	32.00	2.00
626123-0455-038	4.00	38.00	32.00	1.50
626123-0405-039	4.00	39.00	33.00	2.00
626123-0455-039	4.00	39.00	33.00	1.50
626123-0405-040	4.00	40.00	34.00	2.00
626123-0455-040	4.00	40.00	34.00	1.50
626123-0405-041	4.00	41.00	35.00	2.00
626123-0455-041	4.00	41.00	35.00	1.50
626123-0405-042	4.00	42.00	36.00	2.00
626123-0455-042	4.00	42.00	36.00	1.50
626123-0405-043	4.00	43.00	37.00	2.00
626123-0455-043	4.00	43.00	37.00	1.50
626123-0405-044	4.00	44.00	38.00	2.00
626123-0455-044	4.00	44.00	38.00	1.50
626123-0405-045	4.00	45.00	39.00	2.00
626123-0455-045	4.00	45.00	39.00	1.50
626123-0405-046	4.00	46.00	40.00	2.00
626123-0455-046	4.00	46.00	40.00	1.50
626123-0405-047	4.00	47.00	41.00	2.00
626123-0455-047	4.00	47.00	41.00	1.50
626123-0405-048	4.00	48.00	42.00	2.00
626123-0455-048	4.00	48.00	42.00	1.50
626123-0405-049	4.00	49.00	43.00	2.00
626123-0455-049	4.00	49.00	43.00	1.50
626123-0405-050	4.00	50.00	44.00	2.00
626123-0455-050	4.00	50.00	44.00	1.50
626123-0405-051	4.00	51.00	45.00	2.00
626123-0455-051	4.00	51.00	45.00	1.50
626123-0405-052	4.00	52.00	46.00	2.00
626123-0455-052	4.00	52.00	46.00	1.50
626123-0405-053	4.00	53.00	47.00	2.00
626123-0455-053	4.00	53.00	47.00	1.50
626123-0405-054	4.00	54.00	48.00	2.00
626123-0455-054	4.00	54.00	48.00	1.50
626123-0405-055	4.00	55.00	49.00	2.00



Article-No.	DK	L	ML	DS
626123-0455-055	4.00	55.00	49.00	1.50
626123-0405-056	4.00	56.00	50.00	2.00
626123-0455-056	4.00	56.00	50.00	1.50
626123-0405-057	4.00	57.00	51.00	2.00
626123-0455-057	4.00	57.00	51.00	1.50
626123-0405-058	4.00	58.00	52.00	2.00
626123-0455-058	4.00	58.00	52.00	1.50
626123-0405-059	4.00	59.00	53.00	2.00
626123-0455-059	4.00	59.00	53.00	1.50
626123-0455-060	4.00	60.00	54.00	1.50
626123-0405-060	4.00	60.00	54.00	2.00
626123-0405-061	4.00	61.00	55.00	2.00
626123-0405-062	4.00	62.00	56.00	2.00
626123-0405-063	4.00	63.00	57.00	2.00
626123-0405-064	4.00	64.00	58.00	2.00
626123-0405-065	4.00	65.00	59.00	2.00
626123-0405-066	4.00	66.00	60.00	2.00
626123-0405-067	4.00	67.00	61.00	2.00
626123-0405-068	4.00	68.00	62.00	2.00
626123-0405-069	4.00	69.00	63.00	2.00
626123-0405-070	4.00	70.00	64.00	2.00
626123-0405-071	4.00	71.00	65.00	2.00
626123-0405-072	4.00	72.00	66.00	2.00
626123-0405-073	4.00	73.00	67.00	2.00
626123-0405-074	4.00	74.00	68.00	2.00
626123-0405-075	4.00	75.00	69.00	2.00
626123-0405-076	4.00	76.00	70.00	2.00
626123-0405-077	4.00	77.00	71.00	2.00
626123-0405-078	4.00	78.00	72.00	2.00
626123-0405-079	4.00	79.00	73.00	2.00
626123-0405-080	4.00	80.00	74.00	2.00
626123-0405-081	4.00	81.00	75.00	2.00
626123-0405-082	4.00	82.00	76.00	2.00
626123-0405-083	4.00	83.00	77.00	2.00
626123-0405-084	4.00	84.00	78.00	2.00
626123-0405-085	4.00	85.00	79.00	2.00
626123-0405-086	4.00	86.00	80.00	2.00
626123-0405-087	4.00	87.00	81.00	2.00
626123-0405-088	4.00	88.00	82.00	2.00
626123-0405-089	4.00	89.00	83.00	2.00
626123-0405-090	4.00	90.00	84.00	2.00
626123-0405-091	4.00	91.00	85.00	2.00
626123-0405-092	4.00	92.00	86.00	2.00
626123-0405-093	4.00	93.00	87.00	2.00
626123-0405-094	4.00	94.00	88.00	2.00
626123-0405-095	4.00	95.00	89.00	2.00
626123-0405-096	4.00	96.00	90.00	2.00
626123-0405-097	4.00	97.00	91.00	2.00
626123-0405-098	4.00	98.00	92.00	2.00
626123-0405-099	4.00	99.00	93.00	2.00
626123-0405-100	4.00	100.00	94.00	2.00
626123-0405-101	4.00	101.00	95.00	2.00
626123-0405-102	4.00	102.00	96.00	2.00
626123-0405-103	4.00	103.00	97.00	2.00



Article-No.	DK	L	ML	DS
626123-0405-104	4.00	104.00	98.00	2.00
626123-0405-105	4.00	105.00	99.00	2.00
626123-0405-106	4.00	106.00	100.00	2.00
626123-0405-107	4.00	107.00	101.00	2.00
626123-0405-108	4.00	108.00	102.00	2.00
626123-0405-109	4.00	109.00	103.00	2.00
626123-0405-110	4.00	110.00	104.00	2.00
626123-0405-111	4.00	111.00	105.00	2.00
626123-0405-112	4.00	112.00	106.00	2.00
626123-0405-113	4.00	113.00	107.00	2.00
626123-0405-114	4.00	114.00	108.00	2.00
626123-0405-115	4.00	115.00	109.00	2.00
626123-0405-116	4.00	116.00	110.00	2.00
626123-0405-117	4.00	117.00	111.00	2.00
626123-0405-118	4.00	118.00	112.00	2.00
626123-0405-119	4.00	119.00	113.00	2.00
626123-0405-120	4.00	120.00	114.00	2.00
626123-0405-121	4.00	121.00	115.00	2.00
626123-0405-122	4.00	122.00	116.00	2.00
626123-0405-123	4.00	123.00	117.00	2.00
626123-0405-124	4.00	124.00	118.00	2.00
626123-0405-125	4.00	125.00	119.00	2.00
626113-0600-023	6.00	23.00	16.00	2.50

### M3 REN, Styli stepped, ruby sphere, tungsten carbide shaft

Standard Styli suitable for all common measuring tasks. M3 thread for ZEISS RST, Renishaw SP and Hexagon HP-S sensors.

Not for ZEISS VAST XXT sensors (see product notes).

Connection Type: M3  
 Shaft Material: Tung. Carb.  
 Stylus Tip Geometry: Sphere  
 Stylus Tip Material: Ruby  
 Ø Body (DG): 4

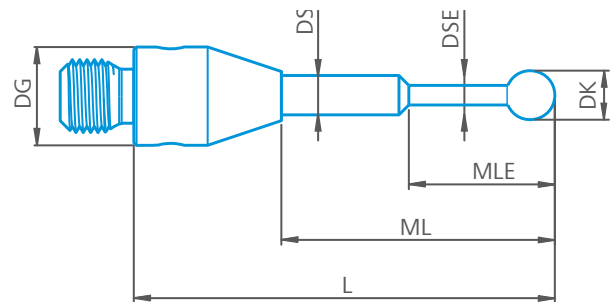

Article-No.	DK	L	ML	DS	MLE	DSE
626123-5144-009	0.20	9.00	3.00	1.00	3.00	0.15
626123-5144-010	0.20	10.00	4.00	1.00	3.00	0.15
626123-5144-011	0.20	11.00	5.00	1.00	3.00	0.15
626123-5144-012	0.20	12.00	6.00	1.00	3.00	0.15
626123-5144-013	0.20	13.00	7.00	1.00	3.00	0.15
626123-5144-014	0.20	14.00	8.00	1.00	3.00	0.15
626123-5144-015	0.20	15.00	9.00	1.00	3.00	0.15
626123-5144-016	0.20	16.00	10.00	1.00	3.00	0.15
626123-5144-017	0.20	17.00	11.00	1.00	3.00	0.15
626123-5144-018	0.20	18.00	12.00	1.00	3.00	0.15
626123-5144-019	0.20	19.00	13.00	1.00	3.00	0.15



Article-No.	DK	L	ML	DS	MLE	DSE
626123-5144-020	0.20	20.00	14.00	1.00	3.00	0.15
626123-5144-021	0.20	21.00	15.00	1.00	3.00	0.15
626123-5144-022	0.20	22.00	16.00	1.00	3.00	0.15
626123-5144-023	0.20	23.00	17.00	1.00	3.00	0.15
626123-5144-024	0.20	24.00	18.00	1.00	3.00	0.15
626123-5144-025	0.20	25.00	19.00	1.00	3.00	0.15
626113-0020-041	0.20	41.00	34.00	1.00	2.60	0.17
626123-5244-009	0.30	9.00	3.00	1.00	2.30	0.20
626123-5244-010	0.30	10.00	4.00	1.00	2.30	0.20
626123-5244-011	0.30	11.00	5.00	1.00	2.30	0.20
626123-5244-012	0.30	12.00	6.00	1.00	2.30	0.20
626123-5244-013	0.30	13.00	7.00	1.00	2.30	0.20
626123-5244-014	0.30	14.00	8.00	1.00	2.30	0.20
626123-5244-015	0.30	15.00	9.00	1.00	2.30	0.20
626123-5244-016	0.30	16.00	10.00	1.00	2.30	0.20
626123-5244-017	0.30	17.00	11.00	1.00	2.30	0.20
626123-5244-018	0.30	18.00	12.00	1.00	2.30	0.20
626123-5244-019	0.30	19.00	13.00	1.00	2.30	0.20
626123-5244-020	0.30	20.00	14.00	1.00	2.30	0.20
626113-0031-020	0.30	20.00	7.00	1.00	6.00	0.20
626113-0032-020	0.30	20.00	7.00	1.00	4.00	0.20
626113-5000-204	0.30	20.00	13.00	1.00	4.80	0.23
626123-5244-021	0.30	21.00	15.00	1.00	2.30	0.20
602030-8121-000	0.30	22.00	9.00	1.00	2.30	0.20
626123-5244-022	0.30	22.00	16.00	1.00	2.30	0.20
626123-5244-023	0.30	23.00	17.00	1.00	2.30	0.20
626123-5244-024	0.30	24.00	18.00	1.00	2.30	0.20
626123-5244-025	0.30	25.00	19.00	1.00	2.30	0.20
626113-0034-025	0.30	25.00	18.00	0.60	2.30	0.20
626113-0030-035	0.30	35.00	26.00	1.00	2.30	0.20
626123-5344-009	0.40	9.00	3.00	1.00	2.30	0.30
626123-5344-010	0.40	10.00	4.00	1.00	2.30	0.30
626123-5344-011	0.40	11.00	5.00	1.00	2.30	0.30
626123-5344-012	0.40	12.00	6.00	1.00	2.30	0.30
626123-5344-013	0.40	13.00	7.00	1.00	2.30	0.30
626123-5344-014	0.40	14.00	8.00	1.00	2.30	0.30
626123-5344-015	0.40	15.00	9.00	1.00	2.30	0.30
626123-5344-016	0.40	16.00	10.00	1.00	2.30	0.30
626123-5344-017	0.40	17.00	11.00	1.00	2.30	0.30
626123-5344-018	0.40	18.00	12.00	1.00	2.30	0.30
626123-5344-019	0.40	19.00	13.00	1.00	2.30	0.30
626123-5344-020	0.40	20.00	14.00	1.00	2.30	0.30
626123-5344-021	0.40	21.00	15.00	1.00	2.30	0.30
626123-5344-022	0.40	22.00	16.00	1.00	2.30	0.30
626123-5344-023	0.40	23.00	17.00	1.00	2.30	0.30
626123-5344-024	0.40	24.00	18.00	1.00	2.30	0.30
626123-5344-025	0.40	25.00	19.00	1.00	2.30	0.30
626123-5444-009	0.50	9.00	3.00	1.00	2.50	0.30
626123-5444-010	0.50	10.00	4.00	1.00	2.50	0.30
626123-5444-011	0.50	11.00	5.00	1.00	2.50	0.30
626123-5444-012	0.50	12.00	6.00	1.00	2.50	0.30
626123-5444-013	0.50	13.00	7.00	1.00	2.50	0.30
626123-5444-014	0.50	14.00	8.00	1.00	2.50	0.30
626123-5444-015	0.50	15.00	9.00	1.00	2.50	0.30



Article-No.	DK	L	ML	DS	MLE	DSE
626123-5444-016	0.50	16.00	10.00	1.00	2.50	0.30
626123-5444-017	0.50	17.00	11.00	1.00	2.50	0.30
626123-5444-018	0.50	18.00	12.00	1.00	2.50	0.30
626123-5444-019	0.50	19.00	13.00	1.00	2.50	0.30
626123-5444-020	0.50	20.00	14.00	1.00	2.50	0.30
626123-5444-021	0.50	21.00	15.00	1.00	2.50	0.30
602030-8115-000	0.50	21.25	11.25	1.00	2.50	0.30
626113-0050-022	0.50	21.25	15.25	1.00	2.50	0.30
626113-0052-022	0.50	21.25	14.25	1.00	5.50	0.30
626123-5444-022	0.50	22.00	16.00	1.00	2.50	0.30
626123-5444-023	0.50	23.00	17.00	1.00	2.50	0.30
626123-5444-024	0.50	24.00	18.00	1.00	2.50	0.30
626123-5444-025	0.50	25.00	19.00	1.00	2.50	0.30
626123-5544-011	0.60	11.00	5.00	1.00	4.60	0.40
626123-5544-012	0.60	12.00	6.00	1.00	4.60	0.40
626123-5544-013	0.60	13.00	7.00	1.00	4.60	0.40
626123-5544-014	0.60	14.00	8.00	1.00	4.60	0.40
626123-5544-015	0.60	15.00	9.00	1.00	4.60	0.40
626123-5544-016	0.60	16.00	10.00	1.00	4.60	0.40
626123-5544-017	0.60	17.00	11.00	1.00	4.60	0.40
626123-5544-018	0.60	18.00	12.00	1.00	4.60	0.40
626123-5544-019	0.60	19.00	13.00	1.00	4.60	0.40
626123-5544-020	0.60	20.00	14.00	1.00	4.60	0.40
626123-5544-021	0.60	21.00	15.00	1.00	4.60	0.40
602030-8116-000	0.60	22.00	9.00	1.00	4.60	0.40
626123-5544-022	0.60	22.00	16.00	1.00	4.60	0.40
626113-0060-022	0.60	22.00	15.00	1.00	6.00	0.40
626123-5544-023	0.60	23.00	17.00	1.00	4.60	0.40
626123-5544-024	0.60	24.00	18.00	1.00	4.60	0.40
626123-5544-025	0.60	25.00	19.00	1.00	4.60	0.40
626113-0070-015	0.70	15.00	8.00	1.00	5.00	0.50
626113-0070-020	0.70	20.00	13.00	1.00	5.00	0.50
626123-5644-011	0.80	11.00	5.00	1.00	4.80	0.60
626123-5644-012	0.80	12.00	6.00	1.00	4.80	0.60
626123-5644-013	0.80	13.00	7.00	1.00	4.80	0.60
626123-5644-014	0.80	14.00	8.00	1.00	4.80	0.60
626123-5644-015	0.80	15.00	9.00	1.00	4.80	0.60
626123-5644-016	0.80	16.00	10.00	1.00	4.80	0.60
626123-5644-017	0.80	17.00	11.00	1.00	4.80	0.60
626123-5644-018	0.80	18.00	12.00	1.00	4.80	0.60
626123-5644-019	0.80	19.00	13.00	1.00	4.80	0.60
626123-5644-020	0.80	20.00	14.00	1.00	4.80	0.60
626113-0081-020	0.80	20.00	12.00	1.00	4.00	0.60
626113-0087-020	0.80	20.00	14.00	1.00	10.00	0.60
626123-5644-021	0.80	21.00	15.00	1.00	4.80	0.60
602030-8117-000	0.80	22.00	9.00	1.00	4.80	0.60
626123-5644-022	0.80	22.00	16.00	1.00	4.80	0.60
626123-5644-023	0.80	23.00	17.00	1.00	4.80	0.60
626123-5644-024	0.80	24.00	18.00	1.00	4.80	0.60
626123-5644-025	0.80	25.00	19.00	1.00	4.80	0.60
626123-5644-026	0.80	26.00	20.00	1.00	4.80	0.60



Article-No.	DK	L	ML	DS	MLE	DSE
626123-5644-027	0.80	27.00	21.00	1.00	4.80	0.60
626123-5644-028	0.80	28.00	22.00	1.00	4.80	0.60
626123-5644-029	0.80	29.00	23.00	1.00	4.80	0.60
626123-5644-030	0.80	30.00	24.00	1.00	4.80	0.60
626113-0080-030	0.80	30.00	22.00	1.00	4.00	0.60
626123-5644-031	0.80	31.00	25.00	1.00	4.80	0.60
626123-5644-032	0.80	32.00	26.00	1.00	4.80	0.60
626123-5644-033	0.80	33.00	27.00	1.00	4.80	0.60
626123-5644-034	0.80	34.00	28.00	1.00	4.80	0.60
626123-5644-035	0.80	35.00	29.00	1.00	4.80	0.60
626113-0080-041	0.80	41.00	31.00	1.50	13.00	0.50
626113-0090-025	0.90	25.00	19.00	1.00	4.00	0.60
626123-0044-011	1.00	11.00	5.00	1.00	5.00	0.80
626113-0100-011	1.00	11.00	5.00	1.00	3.00	0.70
626123-0044-012	1.00	12.00	6.00	1.00	5.00	0.80
626123-0044-013	1.00	13.00	7.00	1.00	5.00	0.80
626123-0044-014	1.00	14.00	8.00	1.00	5.00	0.80
626123-0044-015	1.00	15.00	9.00	1.00	5.00	0.80
626123-0044-016	1.00	16.00	10.00	1.00	5.00	0.80
626123-0044-017	1.00	17.00	11.00	1.00	5.00	0.80
626123-0044-018	1.00	18.00	12.00	1.00	5.00	0.80
626123-0044-019	1.00	19.00	13.00	1.00	5.00	0.80
626123-0044-020	1.00	20.00	14.00	1.00	5.00	0.80
626123-0044-021	1.00	21.00	15.00	1.00	5.00	0.80
602030-8118-000	1.00	22.00	9.00	1.00	5.00	0.80
626123-0044-022	1.00	22.00	16.00	1.00	5.00	0.80
626123-0044-023	1.00	23.00	17.00	1.00	5.00	0.80
626123-0044-024	1.00	24.00	18.00	1.00	5.00	0.80
626123-0044-025	1.00	25.00	19.00	1.00	5.00	0.80
626123-0044-026	1.00	26.00	20.00	1.00	5.00	0.80
626123-0044-027	1.00	27.00	21.00	1.00	5.00	0.80
626123-0044-028	1.00	28.00	22.00	1.00	5.00	0.80
626123-0044-029	1.00	29.00	23.00	1.00	5.00	0.80
626123-0044-030	1.00	30.00	24.00	1.00	5.00	0.80
626123-0044-031	1.00	31.00	25.00	1.00	5.00	0.80
626123-0044-032	1.00	32.00	26.00	1.00	5.00	0.80
626123-0044-033	1.00	33.00	27.00	1.00	5.00	0.80
626123-0044-034	1.00	34.00	28.00	1.00	5.00	0.80
626123-0044-035	1.00	35.00	29.00	1.00	5.00	0.80
626123-0044-036	1.00	36.00	30.00	1.00	5.00	0.80
626123-0044-037	1.00	37.00	31.00	1.00	5.00	0.80
626123-0044-038	1.00	38.00	32.00	1.00	5.00	0.80
626123-0044-039	1.00	39.00	33.00	1.00	5.00	0.80
626123-0044-040	1.00	40.00	34.00	1.00	5.00	0.80
626113-0104-040	1.00	40.00	34.00	1.00	20.00	0.80
626123-0044-041	1.00	41.00	35.00	1.00	5.00	0.80
626123-0044-042	1.00	42.00	36.00	1.00	5.00	0.80
626123-0044-043	1.00	43.00	37.00	1.00	5.00	0.80
626123-0044-044	1.00	44.00	38.00	1.00	5.00	0.80
626123-0044-045	1.00	45.00	39.00	1.00	5.00	0.80
626113-0100-053	1.00	53.00	45.00	1.00	5.00	0.80
626113-0100-060	1.00	60.00	55.00	3.00	21.00	0.80
626113-0152-025	1.50	25.00	19.00	1.00	4.00	0.70
626113-0200-060	2.00	60.00	54.00	4.00	30.00	1.50



Article-No.	DK	L	ML	DS	MLE	DSE
626113-0300-090	3.00	90.00	80.00	2.50	24.00	1.50
626113-0401-075	4.00	75.00	68.00	2.50	15.00	2.00

### M3 REN, Styli stepped, silicon nitride sphere, tungsten carbide shaft

Standard Styli suitable for all common measuring tasks. M3 thread for ZEISS RST, Renishaw SP and Hexagon HP-S sensors.

Not for ZEISS VAST XXT sensors (see product notes).

Connection Type: M3  
 Shaft Material: Tung. Carb.  
 Stylus Tip Geometry: Sphere  
 Stylus Tip Material: Si. Nitride  
 Ø Body (DG): 4

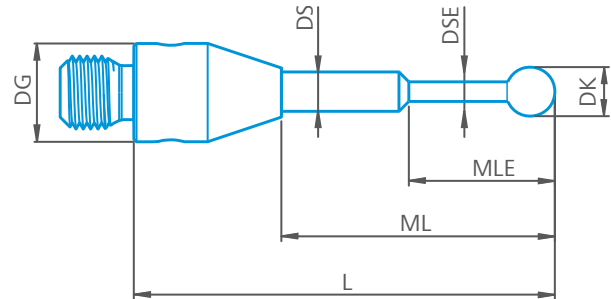

Article-No.	DK	L	ML	DS	MLE	DSE
626123-5245-009	0.30	9.00	3.00	1.00	2.30	0.20
626123-5245-010	0.30	10.00	4.00	1.00	2.30	0.20
626123-5245-011	0.30	11.00	5.00	1.00	2.30	0.20
626123-5245-012	0.30	12.00	6.00	1.00	2.30	0.20
626123-5245-013	0.30	13.00	7.00	1.00	2.30	0.20
626123-5245-014	0.30	14.00	8.00	1.00	2.30	0.20
626123-5245-015	0.30	15.00	9.00	1.00	2.30	0.20
626123-5245-016	0.30	16.00	10.00	1.00	2.30	0.20
626123-5245-017	0.30	17.00	11.00	1.00	2.30	0.20
626123-5245-018	0.30	18.00	12.00	1.00	2.30	0.20
626123-5245-019	0.30	19.00	13.00	1.00	2.30	0.20
626123-5245-020	0.30	20.00	14.00	1.00	2.30	0.20
626123-5245-021	0.30	21.00	15.00	1.00	2.30	0.20
626123-5245-022	0.30	22.00	16.00	1.00	2.30	0.20
626123-5245-023	0.30	23.00	17.00	1.00	2.30	0.20
626123-5245-024	0.30	24.00	18.00	1.00	2.30	0.20
626123-5245-025	0.30	25.00	19.00	1.00	2.30	0.20
626123-5445-009	0.50	9.00	3.00	1.00	2.50	0.30
626123-5445-010	0.50	10.00	4.00	1.00	2.50	0.30
626123-5445-011	0.50	11.00	5.00	1.00	2.50	0.30
626123-5445-012	0.50	12.00	6.00	1.00	2.50	0.30
626123-5445-013	0.50	13.00	7.00	1.00	2.50	0.30
626123-5445-014	0.50	14.00	8.00	1.00	2.50	0.30
626123-5445-015	0.50	15.00	9.00	1.00	2.50	0.30
626123-5445-016	0.50	16.00	10.00	1.00	2.50	0.30
626123-5445-017	0.50	17.00	11.00	1.00	2.50	0.30
626123-5445-018	0.50	18.00	12.00	1.00	2.50	0.30
626123-5445-019	0.50	19.00	13.00	1.00	2.50	0.30
626123-5445-020	0.50	20.00	14.00	1.00	2.50	0.30
626123-5445-021	0.50	21.00	15.00	1.00	2.50	0.30
626123-5445-022	0.50	22.00	16.00	1.00	2.50	0.30
626123-5445-023	0.50	23.00	17.00	1.00	2.50	0.30





Article-No.	DK	L	ML	DS	MLE	DSE
626123-5445-024	0.50	24.00	18.00	1.00	2.50	0.30
626123-5445-025	0.50	25.00	19.00	1.00	2.50	0.30
626123-5545-011	0.60	11.00	5.00	1.00	4.60	0.40
626123-5545-012	0.60	12.00	6.00	1.00	4.60	0.40
626123-5545-013	0.60	13.00	7.00	1.00	4.60	0.40
626123-5545-014	0.60	14.00	8.00	1.00	4.60	0.40
626123-5545-015	0.60	15.00	9.00	1.00	4.60	0.40
626123-5545-016	0.60	16.00	10.00	1.00	4.60	0.40
626123-5545-017	0.60	17.00	11.00	1.00	4.60	0.40
626123-5545-018	0.60	18.00	12.00	1.00	4.60	0.40
626123-5545-019	0.60	19.00	13.00	1.00	4.60	0.40
626123-5545-020	0.60	20.00	14.00	1.00	4.60	0.40
626123-5545-021	0.60	21.00	15.00	1.00	4.60	0.40
626123-5545-022	0.60	22.00	16.00	1.00	4.60	0.40
626123-5545-023	0.60	23.00	17.00	1.00	4.60	0.40
626123-5545-024	0.60	24.00	18.00	1.00	4.60	0.40
626123-5545-025	0.60	25.00	19.00	1.00	4.60	0.40
626123-5645-011	0.80	11.00	5.00	1.00	4.80	0.60
626123-5645-012	0.80	12.00	6.00	1.00	4.80	0.60
626113-0080-012	0.80	12.00	5.00	1.00	4.00	0.60
626123-5645-013	0.80	13.00	7.00	1.00	4.80	0.60
626123-5645-014	0.80	14.00	8.00	1.00	4.80	0.60
626123-5645-015	0.80	15.00	9.00	1.00	4.80	0.60
626123-5645-016	0.80	16.00	10.00	1.00	4.80	0.60
626123-5645-017	0.80	17.00	11.00	1.00	4.80	0.60
626123-5645-018	0.80	18.00	12.00	1.00	4.80	0.60
626123-5645-019	0.80	19.00	13.00	1.00	4.80	0.60
626123-5645-020	0.80	20.00	14.00	1.00	4.80	0.60
626123-5645-021	0.80	21.00	15.00	1.00	4.80	0.60
626123-5645-022	0.80	22.00	16.00	1.00	4.80	0.60
626123-5645-023	0.80	23.00	17.00	1.00	4.80	0.60
626123-5645-024	0.80	24.00	18.00	1.00	4.80	0.60
626123-5645-025	0.80	25.00	19.00	1.00	4.80	0.60
626123-5645-026	0.80	26.00	20.00	1.00	4.80	0.60
626123-5645-027	0.80	27.00	21.00	1.00	4.80	0.60
626123-5645-028	0.80	28.00	22.00	1.00	4.80	0.60
626123-5645-029	0.80	29.00	23.00	1.00	4.80	0.60
626123-5645-030	0.80	30.00	24.00	1.00	4.80	0.60
626123-5645-031	0.80	31.00	25.00	1.00	4.80	0.60
626123-5645-032	0.80	32.00	26.00	1.00	4.80	0.60
626123-5645-033	0.80	33.00	27.00	1.00	4.80	0.60
626123-5645-034	0.80	34.00	28.00	1.00	4.80	0.60
626123-5645-035	0.80	35.00	29.00	1.00	4.80	0.60
626123-5645-036	0.80	36.00	30.00	1.00	4.80	0.60
626123-5645-037	0.80	37.00	31.00	1.00	4.80	0.60
626123-5645-038	0.80	38.00	32.00	1.00	4.80	0.60
626123-5645-039	0.80	39.00	33.00	1.00	4.80	0.60
626123-5645-040	0.80	40.00	34.00	1.00	4.80	0.60
626123-0045-011	1.00	11.00	5.00	1.00	5.00	0.80
626123-0045-012	1.00	12.00	6.00	1.00	5.00	0.80
626123-0045-013	1.00	13.00	7.00	1.00	5.00	0.80
626123-0045-014	1.00	14.00	8.00	1.00	5.00	0.80
626123-0045-015	1.00	15.00	9.00	1.00	5.00	0.80
626123-0045-016	1.00	16.00	10.00	1.00	5.00	0.80



Article-No.	DK	L	ML	DS	MLE	DSE
626123-0045-017	1.00	17.00	11.00	1.00	5.00	0.80
626123-0045-018	1.00	18.00	12.00	1.00	5.00	0.80
626123-0045-019	1.00	19.00	13.00	1.00	5.00	0.80
626123-0045-020	1.00	20.00	14.00	1.00	5.00	0.80
626123-0045-021	1.00	21.00	15.00	1.00	5.00	0.80
626123-0045-022	1.00	22.00	16.00	1.00	5.00	0.80
626123-0045-023	1.00	23.00	17.00	1.00	5.00	0.80
626123-0045-024	1.00	24.00	18.00	1.00	5.00	0.80
626123-0045-025	1.00	25.00	19.00	1.00	5.00	0.80
626123-0045-026	1.00	26.00	20.00	1.00	5.00	0.80
626123-0045-027	1.00	27.00	21.00	1.00	5.00	0.80
626123-0045-028	1.00	28.00	22.00	1.00	5.00	0.80
626123-0045-029	1.00	29.00	23.00	1.00	5.00	0.80
626123-0045-030	1.00	30.00	24.00	1.00	5.00	0.80
626123-0045-031	1.00	31.00	25.00	1.00	5.00	0.80
626123-0045-032	1.00	32.00	26.00	1.00	5.00	0.80
626123-0045-033	1.00	33.00	27.00	1.00	5.00	0.80
626123-0045-034	1.00	34.00	28.00	1.00	5.00	0.80
626123-0045-035	1.00	35.00	29.00	1.00	5.00	0.80
626123-0045-036	1.00	36.00	30.00	1.00	5.00	0.80
626123-0045-037	1.00	37.00	31.00	1.00	5.00	0.80
626123-0045-038	1.00	38.00	32.00	1.00	5.00	0.80
626123-0045-039	1.00	39.00	33.00	1.00	5.00	0.80
626123-0045-040	1.00	40.00	34.00	1.00	5.00	0.80
626123-0045-041	1.00	41.00	35.00	1.00	5.00	0.80
626123-0045-042	1.00	42.00	36.00	1.00	5.00	0.80
626123-0045-043	1.00	43.00	37.00	1.00	5.00	0.80
626123-0045-044	1.00	44.00	38.00	1.00	5.00	0.80
626123-0045-045	1.00	45.00	39.00	1.00	5.00	0.80
626113-0303-016	3.00	16.00	10.00	1.50	5.00	0.50

# Cylinder styli

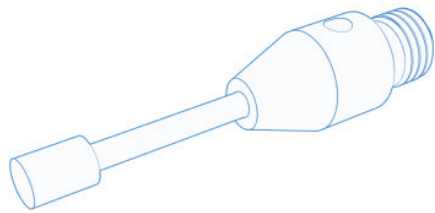

Cylindrical styli measure two-dimensionally and are particularly suitable for thin sheets. Narrow workpiece edges can also be measured well with cylindrical measuring probes. However, the probe axis must be mechanically aligned very precisely with the feature axis on the workpiece. As a special form, spherical cylindrical styli are available, which are also mostly used for sheet metal measurement and measurement at sheet metal edges. They have spherical end and can thus additionally determine the flatness of a surface, for example.

## M3 REN, Cylinder styli, tungsten carbide cylinder, tungsten carbide shaft

Cylindrical styli for thin sheets and narrow workpiece edges. M3 thread for ZEISS RST, Renishaw SP and Hexagon HP-S sensors.

Not for ZEISS VAST XXT sensors (see product notes).

Connection Type: M3  
 Shaft Material: Tung. Carb.  
 Stylus Tip Geometry: Cylinder  
 Stylus Tip Material: Tung. Carb.  
 Ø Body (DG): 4

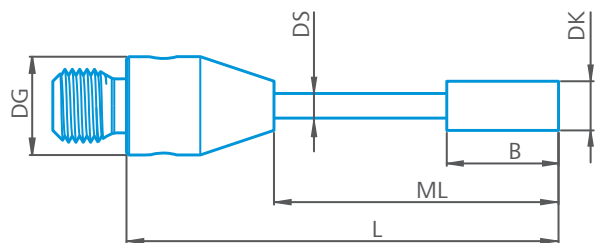

Article-No.	DK	L	ML	DS	B
626113-0082-020	0.80	20.00	12.00	0.60	1.50
602030-8097-000	1.50	11.00	4.50	1.00	1.50
626113-0152-015	1.50	15.00	8.00	1.00	2.00
626113-0150-028	1.50	28.00	15.00	1.00	4.00
626113-0200-018	2.00	17.50	10.50	1.50	5.00
626113-0200-023	2.00	23.00	16.00	1.50	2.00
602030-8099-000	3.00	13.00	7.00	1.00	4.00
626113-0400-030	4.00	30.00	26.00	2.00	10.00
626113-0400-060	4.00	60.00	50.00	1.00	4.00
626113-0600-025	6.00	25.00	18.00	3.00	4.00
626113-5000-158	6.00	50.00	43.00	1.50	3.00
626113-0800-040	8.00	40.00	31.00	2.00	10.00

### M3 REN, Cylinder styli, ruby cylinder, ceramic shaft

Cylindrical styli for thin sheets and narrow workpiece edges. M3 thread for ZEISS RST, Renishaw SP and Hexagon HP-S sensors.

Not for ZEISS VAST XXT sensors (see product notes).

Connection Type: M3  
 Shaft Material: Ceramic  
 Stylus Tip Geometry: Cylinder  
 Stylus Tip Material: Ruby  
 Ø Body (DG): 4

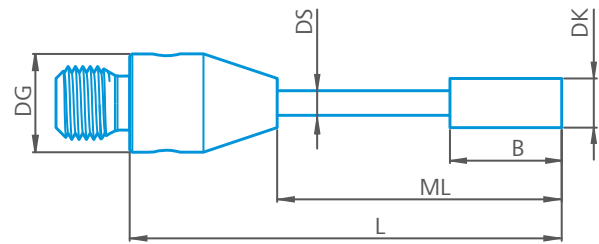

Article-No.	DK	L	ML	DS	B
626113-0400-020	4.00	20.00	14.00	2.00	4.00

### M3 REN, Spherical cylinder styli, ruby Spherical cylinder, tungsten carbide shaft

Cylindrical styli for thin sheets and narrow workpiece edges. In addition surface measurement with the spherical tip. M3 thread for ZEISS RST, Renishaw SP and Hexagon HP-S sensors.

Not for ZEISS VAST XXT sensors (see product notes).

Connection Type: M3  
 Shaft Material: Tung. Carb.  
 Stylus Tip Geometry: Spherical Cylinder  
 Stylus Tip Material: Ruby  
 Ø Body (DG): 4

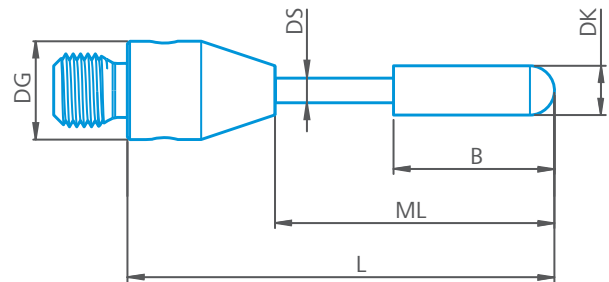

Article-No.	DK	L	ML	DS	B
602030-8107-000	2.00	21.00	13.00	1.00	7.20
626120-0276-000	2.00	42.00	32.00	1.00	7.00



## M3 REN, Cylinder styli, tungsten carbide cylinder, without shaft

Cylindrical styli for thin sheets and narrow workpiece edges. M3 thread for ZEISS RST, Renishaw SP and Hexagon HP-S sensors.

Not for ZEISS VAST XXT sensors (see product notes).

Connection Type: M3

Shaft Material: Tung. Carb.

Stylus Tip Geometry: Cylinder

Stylus Tip Material: Tung. Carb.

Ø Body (DG): 4

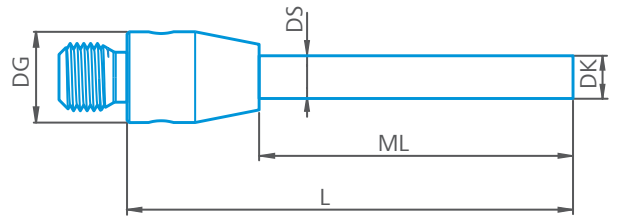

Article-No.	DK	L	ML	DS	B
626113-0150-016	1.50	16.00	10.00	1.50	10.00
626113-0201-022	2.00	22.00	16.00	2.00	16.00
626113-0201-033	2.00	33.00	27.00	2.00	27.00

## M2

Styli with M2 thread suitable for Renishaw TP and Hexagon HP touch probes

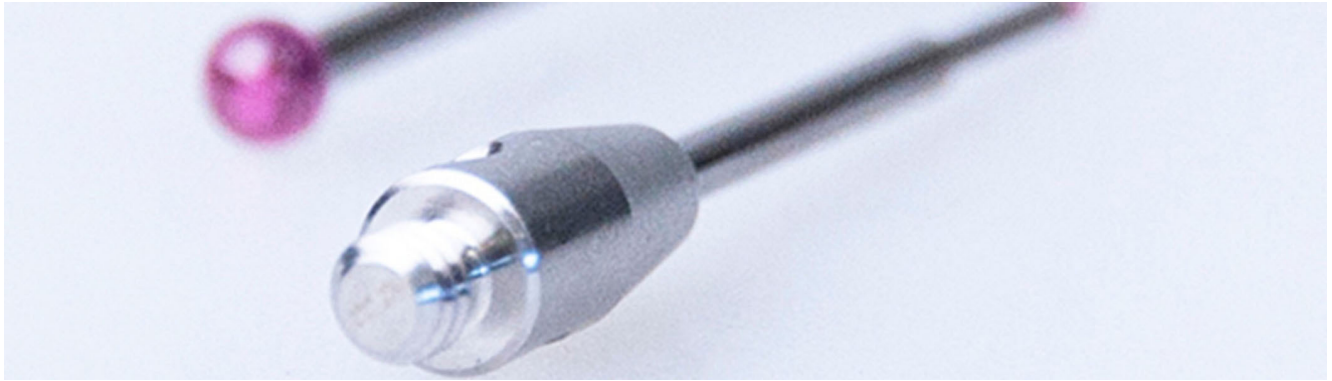

Styli with M2 thread are especially suitable for switching probes. With the appropriate connecting element they can also be connected to other thread systems. In the M2 range, styli using ruby or silicon nitride spheres are available. The shaft is made of tungsten carbide as standard. Cylindrical styli, which are made entirely of tungsten carbide, and disk styli made of ceramic, are also available.

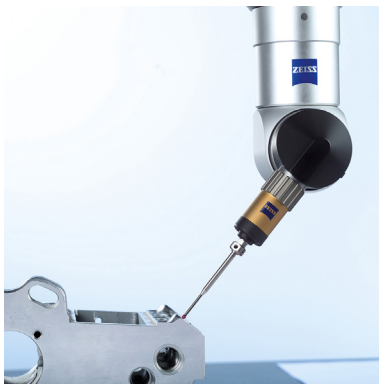

### The main application range of M2 styli is TP20 probes

The TP20 probe is a kinematic 5- or 6-way probe consisting of two parts which are connected via a magnetic coupling. The basic element is the stylus mount, the associated stylus modules are removable and available with different probing forces. The TP20 modules are not scanning capable and therefore have a significantly smaller data volume when measuring components than with VAST technology. ZEISS uses the TP20 modules primarily on horizontal-arm CMMs for the measurement of sheet metal parts with freeform surfaces in which a meaningful scanning method cannot be implemented.

### ZEISS stylus dimensioning

Compared to other stylus providers, ZEISS has a special type of stylus dimensioning. The lengths (L, ML, MLE, ...) are dimensioned from the stylus base to the stylus tip. This allows you to see at a glance the available length. As a result, identical styli may differ in length specifications depending on whether you consider the ZEISS dimensioning or the conventional dimensioning, which refers to the sphere center point instead of the sphere tip.

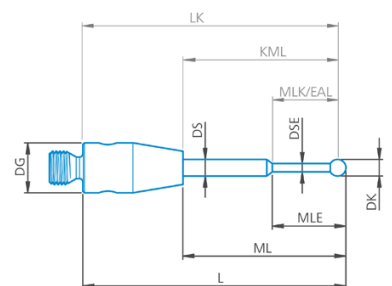

# Reference styli

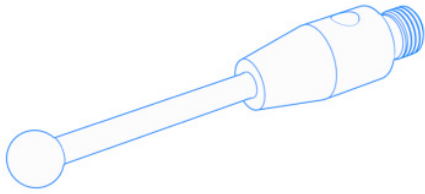

ZEISS reference styli are used to determine the position and geometry of the qualification test piece, usually a sphere. The software thus recognizes the ACTUAL data of the qualification test piece, which can then be compared with the calibrated NOMINAL data in order to detect machine errors. Afterwards, all following styli installed in stylus systems can be qualified in relation to them. Master styli are defined and labeled according to stability and accuracy in a readout procedure. Optimum results can be achieved during qualification.

## M2, Reference styli straight, ceramic shaft

Reference Styli are used to determine the position of calibration reference spheres. M2 threads are common for Renishaw touch sensors.

- Connection Type: M2
- Shaft Material: Ceramic
- Stylus Tip Geometry: Sphere
- Stylus Tip Material: Ruby
- Ø Body (DG): 3

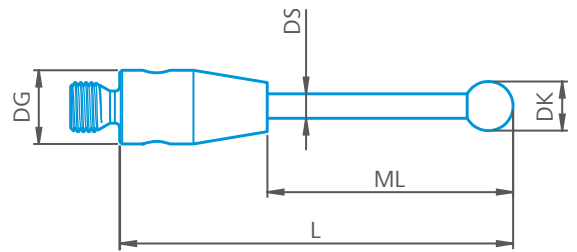

Article-No.	DK	L	ML	DS
000000-1172-967	3.00	62.00	46.00	2.00

## Styli Standard

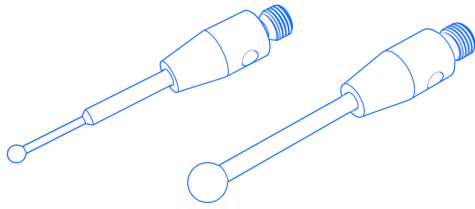

Spherical styli have the largest field of application because they have the same probing behavior in every direction. They are therefore suitable for all common measuring tasks such as measuring bores and surfaces. The larger the stylus sphere size, the larger the mechanical filter. This means that the profile of your workpiece is smoothed, which is often required in form measurement. The deviation from the ideal sphere shape is usually shown in Grade. ZEISS stylus tips come standard with Grade 5, but can also be offered with highly accurate roundness or diameters with a certificate for special requirements. Styli with a straight shaft are the most simple designed styli. The full shaft length can be used as measuring length. Stepped shaft has the advantage of a greater shaft thickness, which is reduced towards the measuring tip. This stepped shaft increases the stability of the shaft while maintaining the same length (depending on the sphere diameter). At the same time, however, the usable measuring length is reduced.

### M2, Styli straight, ruby sphere, tungsten carbide shaft

Standard Styli suitable for all common measuring tasks. M2 threads are common for Renishaw touch sensors.

Connection Type: M2  
 Shaft Material: Tung. Carb.  
 Stylus Tip Geometry: Sphere  
 Stylus Tip Material: Ruby  
 Ø Body (DG): 3

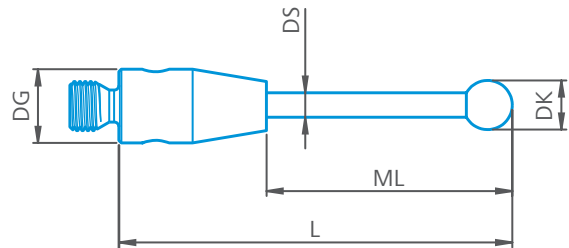

Article-No.	DK	L	ML	DS
626112-0054-020	0.50	20.25	7.25	0.30
626112-0070-010	0.70	10.35	4.35	0.50
626112-0070-020	0.70	20.00	15.00	0.50
626120-0018-000	0.70	20.40	12.40	0.50
626102-5644-010	0.80	10.00	4.00	0.60
626112-0100-010	1.00	10.00	5.50	0.70
602030-8006-000	1.00	10.50	4.50	0.80
626120-0179-000	1.00	10.50	4.50	0.70
626112-0100-015	1.00	15.00	11.00	0.70
602030-8007-000	1.00	15.50	11.50	0.80
626112-0102-020	1.00	20.00	14.00	0.80
626112-0106-021	1.00	20.50	13.00	0.80
626112-0102-022	1.00	20.50	7.50	0.70
626112-0100-021	1.00	20.50	15.50	0.80
626112-0100-025	1.00	25.00	20.50	0.80
626102-0100-026	1.00	25.50	18.50	0.80
626112-0100-028	1.00	27.50	22.50	0.70
626112-0100-027	1.00	28.00	21.00	0.70
626112-0100-031	1.00	31.00	25.00	0.80
626112-0100-050	1.00	50.00	40.00	0.70





Article-No.	DK	L	ML	DS
626102-5744-009	1.35	9.00	3.00	1.00
626102-5744-010	1.35	10.00	4.00	1.00
626102-5744-011	1.35	11.00	5.00	1.00
626102-5744-012	1.35	12.00	6.00	1.00
626102-5744-013	1.35	13.00	7.00	1.00
626102-5744-014	1.35	14.00	8.00	1.00
626102-5744-015	1.35	15.00	9.00	1.00
626102-5744-016	1.35	16.00	10.00	1.00
626102-5744-017	1.35	17.00	11.00	1.00
626102-5744-018	1.35	18.00	12.00	1.00
626102-5744-019	1.35	19.00	13.00	1.00
626102-5744-020	1.35	20.00	14.00	1.00
626102-5744-021	1.35	21.00	15.00	1.00
626102-5744-022	1.35	22.00	16.00	1.00
626102-5744-023	1.35	23.00	17.00	1.00
626102-5744-024	1.35	24.00	18.00	1.00
626102-5744-025	1.35	25.00	19.00	1.00
626102-5744-026	1.35	26.00	20.00	1.00
626102-5744-027	1.35	27.00	21.00	1.00
626102-5744-028	1.35	28.00	22.00	1.00
626102-5744-029	1.35	29.00	23.00	1.00
626102-5744-030	1.35	30.00	24.00	1.00
626102-5744-031	1.35	31.00	25.00	1.00
626102-5744-032	1.35	32.00	26.00	1.00
626102-5744-033	1.35	33.00	27.00	1.00
626102-5744-034	1.35	34.00	28.00	1.00
626102-5744-035	1.35	35.00	29.00	1.00
626102-5744-036	1.35	36.00	30.00	1.00
626102-5744-037	1.35	37.00	31.00	1.00
626102-5744-038	1.35	38.00	32.00	1.00
626102-5744-039	1.35	39.00	33.00	1.00
626102-5744-040	1.35	40.00	34.00	1.00
626102-5744-041	1.35	41.00	35.00	1.00
626102-5744-042	1.35	42.00	36.00	1.00
626102-5744-043	1.35	43.00	37.00	1.00
626102-5744-044	1.35	44.00	38.00	1.00
626102-5744-045	1.35	45.00	39.00	1.00
626102-0144-009	1.50	9.00	3.00	1.00
626102-0144-010	1.50	10.00	4.00	1.00
626102-0144-011	1.50	11.00	5.00	1.00
626102-0144-012	1.50	12.00	6.00	1.00
626102-0144-013	1.50	13.00	7.00	1.00
626102-0144-014	1.50	14.00	8.00	1.00
626102-0144-015	1.50	15.00	9.00	1.00
626102-0144-016	1.50	16.00	10.00	1.00
626112-0150-017	1.50	16.80	10.80	1.00
626102-0144-017	1.50	17.00	11.00	1.00
626102-0144-018	1.50	18.00	12.00	1.00
626102-0144-019	1.50	19.00	13.00	1.00
626102-0144-020	1.50	20.00	14.00	1.00
626102-0144-021	1.50	21.00	15.00	1.00
626102-0144-022	1.50	22.00	16.00	1.00
626102-0144-023	1.50	23.00	17.00	1.00
626102-0144-024	1.50	24.00	18.00	1.00



Article-No.	DK	L	ML	DS
626102-0144-025	1.50	25.00	19.00	1.00
626102-0144-026	1.50	26.00	20.00	1.00
626102-0144-027	1.50	27.00	21.00	1.00
626102-0144-028	1.50	28.00	22.00	1.00
626102-0144-029	1.50	29.00	23.00	1.00
626102-0144-030	1.50	30.00	24.00	1.00
000000-1234-944	1.50	30.70	24.70	1.00
626102-0144-031	1.50	31.00	25.00	1.00
626102-0144-032	1.50	32.00	26.00	1.00
626102-0144-033	1.50	33.00	27.00	1.00
626102-0144-034	1.50	34.00	28.00	1.00
626102-0144-035	1.50	35.00	29.00	1.00
626102-0144-036	1.50	36.00	30.00	1.00
626102-0144-037	1.50	37.00	31.00	1.00
626102-0144-038	1.50	38.00	32.00	1.00
626102-0144-039	1.50	39.00	33.00	1.00
626102-0144-040	1.50	40.00	34.00	1.00
626102-0144-041	1.50	41.00	35.00	1.00
626102-0144-042	1.50	42.00	36.00	1.00
626102-0144-043	1.50	43.00	37.00	1.00
626102-0144-044	1.50	44.00	38.00	1.00
626102-0144-045	1.50	45.00	39.00	1.00
626112-0150-050	1.50	50.00	45.00	1.00
626112-0160-010	1.60	10.00	6.00	1.00
626112-0180-010	1.80	10.00	6.00	1.00
626102-0244-009	2.00	9.00	3.00	1.00
626102-0254-009	2.00	9.00	3.00	1.50
626102-0244-010	2.00	10.00	4.00	1.00
626102-0254-010	2.00	10.00	4.00	1.50
602030-8008-000	2.00	11.00	7.00	1.00
602030-8001-000	2.00	11.00	5.00	1.00
626102-0244-011	2.00	11.00	5.00	1.00
626102-0254-011	2.00	11.00	5.00	1.50
626102-0244-012	2.00	12.00	6.00	1.00
626102-0254-012	2.00	12.00	6.00	1.50
626102-0244-013	2.00	13.00	7.00	1.00
626102-0254-013	2.00	13.00	7.00	1.50
626102-0244-014	2.00	14.00	8.00	1.00
626102-0254-014	2.00	14.00	8.00	1.50
626102-0244-015	2.00	15.00	9.00	1.00
626102-0254-015	2.00	15.00	9.00	1.50
602030-8009-000	2.00	16.00	10.00	1.00
626102-0244-016	2.00	16.00	10.00	1.00
626102-0254-016	2.00	16.00	10.00	1.50
626112-0201-016	2.00	16.00	11.00	1.00
626102-0244-017	2.00	17.00	11.00	1.00
626102-0254-017	2.00	17.00	11.00	1.50
626102-0244-018	2.00	18.00	12.00	1.00
626102-0254-018	2.00	18.00	12.00	1.50
626102-0244-019	2.00	19.00	13.00	1.00
626102-0254-019	2.00	19.00	13.00	1.50



Article-No.	DK	L	ML	DS
626102-0244-020	2.00	20.00	14.00	1.00
626102-0254-020	2.00	20.00	14.00	1.50
626102-0244-021	2.00	21.00	15.00	1.00
626102-0254-021	2.00	21.00	15.00	1.50
602030-8005-000	2.00	21.00	15.00	1.00
626112-0201-021	2.00	21.00	15.00	1.40
626102-0244-022	2.00	22.00	16.00	1.00
626102-0254-022	2.00	22.00	16.00	1.50
626102-0244-023	2.00	23.00	17.00	1.00
626102-0254-023	2.00	23.00	17.00	1.50
626102-0244-024	2.00	24.00	18.00	1.00
626102-0254-024	2.00	24.00	18.00	1.50
626102-0244-025	2.00	25.00	19.00	1.00
626102-0254-025	2.00	25.00	19.00	1.50
626102-0244-026	2.00	26.00	20.00	1.00
626102-0254-026	2.00	26.00	20.00	1.50
626102-0244-027	2.00	27.00	21.00	1.00
626102-0254-027	2.00	27.00	21.00	1.50
626102-0244-028	2.00	28.00	22.00	1.00
626102-0254-028	2.00	28.00	22.00	1.50
626102-0244-029	2.00	29.00	23.00	1.00
626102-0254-029	2.00	29.00	23.00	1.50
626102-0244-030	2.00	30.00	24.00	1.00
626102-0254-030	2.00	30.00	24.00	1.50
626102-0244-031	2.00	31.00	25.00	1.00
626102-0254-031	2.00	31.00	25.00	1.50
626102-0244-032	2.00	32.00	26.00	1.00
626102-0254-032	2.00	32.00	26.00	1.50
626102-0244-033	2.00	33.00	27.00	1.00
626102-0254-033	2.00	33.00	27.00	1.50
626102-0244-034	2.00	34.00	28.00	1.00
626102-0254-034	2.00	34.00	28.00	1.50
626102-0244-035	2.00	35.00	29.00	1.00
626102-0254-035	2.00	35.00	29.00	1.50
626102-0244-036	2.00	36.00	30.00	1.00
626102-0254-036	2.00	36.00	30.00	1.50
626102-0244-037	2.00	37.00	31.00	1.00
626102-0254-037	2.00	37.00	31.00	1.50
626102-0244-038	2.00	38.00	32.00	1.00
626102-0254-038	2.00	38.00	32.00	1.50
626102-0244-039	2.00	39.00	33.00	1.00
626102-0254-039	2.00	39.00	33.00	1.50
626102-0244-040	2.00	40.00	34.00	1.00
626102-0254-040	2.00	40.00	34.00	1.50
626102-0244-041	2.00	41.00	35.00	1.00
626102-0254-041	2.00	41.00	35.00	1.50
626120-0024-000	2.00	41.00	33.50	1.50
626102-0244-042	2.00	42.00	36.00	1.00
626102-0254-042	2.00	42.00	36.00	1.50
626102-0244-043	2.00	43.00	37.00	1.00
626102-0254-043	2.00	43.00	37.00	1.50
626102-0244-044	2.00	44.00	38.00	1.00
626102-0254-044	2.00	44.00	38.00	1.50
626102-0244-045	2.00	45.00	39.00	1.00



Article-No.	DK	L	ML	DS
626102-0254-045	2.00	45.00	39.00	1.50
626102-0254-046	2.00	46.00	40.00	1.50
626102-0254-047	2.00	47.00	41.00	1.50
626102-0254-048	2.00	48.00	42.00	1.50
626102-0254-049	2.00	49.00	43.00	1.50
626102-0254-050	2.00	50.00	44.00	1.50
626102-0254-051	2.00	51.00	45.00	1.50
626102-0254-052	2.00	52.00	46.00	1.50
626102-0254-053	2.00	53.00	47.00	1.50
626102-0254-054	2.00	54.00	48.00	1.50
626102-0254-055	2.00	55.00	49.00	1.50
626102-0254-056	2.00	56.00	50.00	1.50
626102-0254-057	2.00	57.00	51.00	1.50
626102-0254-058	2.00	58.00	52.00	1.50
626102-0254-059	2.00	59.00	53.00	1.50
626102-0254-060	2.00	60.00	54.00	1.50
626112-0200-065	2.00	71.00	65.00	1.50
626102-5854-009	2.50	9.00	3.00	1.50
626102-5854-010	2.50	10.00	4.00	1.50
626102-5854-011	2.50	11.00	5.00	1.50
626102-5854-012	2.50	12.00	6.00	1.50
626102-5854-013	2.50	13.00	7.00	1.50
626102-5854-014	2.50	14.00	8.00	1.50
626102-5854-015	2.50	15.00	9.00	1.50
626102-5854-016	2.50	16.00	10.00	1.50
626102-5854-017	2.50	17.00	11.00	1.50
626102-5854-018	2.50	18.00	12.00	1.50
626102-5854-019	2.50	19.00	13.00	1.50
626102-5854-020	2.50	20.00	14.00	1.50
626102-5854-021	2.50	21.00	15.00	1.50
626112-0250-021	2.50	21.25	15.25	1.40
626102-5854-022	2.50	22.00	16.00	1.50
626102-5854-023	2.50	23.00	17.00	1.50
626102-5854-024	2.50	24.00	18.00	1.50
626102-5854-025	2.50	25.00	19.00	1.50
626102-5854-026	2.50	26.00	20.00	1.50
626102-5854-027	2.50	27.00	21.00	1.50
626102-5854-028	2.50	28.00	22.00	1.50
626102-5854-029	2.50	29.00	23.00	1.50
626102-5854-030	2.50	30.00	24.00	1.50
626102-5854-031	2.50	31.00	25.00	1.50
626102-5854-032	2.50	32.00	26.00	1.50
626102-5854-033	2.50	33.00	27.00	1.50
626102-5854-034	2.50	34.00	28.00	1.50
626102-5854-035	2.50	35.00	29.00	1.50
626102-5854-036	2.50	36.00	30.00	1.50
626102-5854-037	2.50	37.00	31.00	1.50
626102-5854-038	2.50	38.00	32.00	1.50
626102-5854-039	2.50	39.00	33.00	1.50
626102-5854-040	2.50	40.00	34.00	1.50
626102-5854-041	2.50	41.00	35.00	1.50



<b>Article-No.</b>	<b>DK</b>	<b>L</b>	<b>ML</b>	<b>DS</b>
626102-5854-042	2.50	42.00	36.00	1.50
626102-5854-043	2.50	43.00	37.00	1.50
626102-5854-044	2.50	44.00	38.00	1.50
626102-5854-045	2.50	45.00	39.00	1.50
626102-5854-046	2.50	46.00	40.00	1.50
626102-5854-047	2.50	47.00	41.00	1.50
626102-5854-048	2.50	48.00	42.00	1.50
626102-5854-049	2.50	49.00	43.00	1.50
626102-5854-050	2.50	50.00	44.00	1.50
626102-5854-051	2.50	51.00	45.00	1.50
626102-5854-052	2.50	52.00	46.00	1.50
626102-5854-053	2.50	53.00	47.00	1.50
626102-5854-054	2.50	54.00	48.00	1.50
626102-5854-055	2.50	55.00	49.00	1.50
626102-5854-056	2.50	56.00	50.00	1.50
626102-5854-057	2.50	57.00	51.00	1.50
626102-5854-058	2.50	58.00	52.00	1.50
626102-5854-059	2.50	59.00	53.00	1.50
626102-5854-060	2.50	60.00	54.00	1.50
626102-0354-009	3.00	9.00	3.00	1.50
626102-0354-010	3.00	10.00	4.00	1.50
626112-0300-011	3.00	10.50	6.50	1.50
626102-0354-011	3.00	11.00	5.00	1.50
626112-0300-012	3.00	11.50	7.50	0.80
626102-0300-012	3.00	11.50	4.00	1.50
626112-0301-011	3.00	11.50	9.00	1.50
626102-0354-012	3.00	12.00	6.00	1.50
626102-0354-013	3.00	13.00	7.00	1.50
626102-0354-014	3.00	14.00	8.00	1.50
626102-0354-015	3.00	15.00	9.00	1.50
626102-0354-016	3.00	16.00	10.00	1.50
626112-0300-017	3.00	16.50	11.50	2.00
626102-0354-017	3.00	17.00	11.00	1.50
626102-0354-018	3.00	18.00	12.00	1.50
626102-0354-019	3.00	19.00	13.00	1.50
626102-0354-020	3.00	20.00	14.00	1.50
626102-0354-021	3.00	21.00	15.00	1.50
602030-8003-000	3.00	21.50	15.50	1.50
626112-0301-022	3.00	21.50	15.50	1.50
626102-0354-022	3.00	22.00	16.00	1.50
626102-0354-023	3.00	23.00	17.00	1.50
626102-0354-024	3.00	24.00	18.00	1.50
626102-0354-025	3.00	25.00	19.00	1.50
626102-0354-026	3.00	26.00	20.00	1.50
626102-0354-027	3.00	27.00	21.00	1.50
626102-0354-028	3.00	28.00	22.00	1.50
626102-0354-029	3.00	29.00	23.00	1.50
626102-0354-030	3.00	30.00	24.00	1.50
626102-0354-031	3.00	31.00	25.00	1.50
626112-0300-031	3.00	31.00	25.00	2.00
626102-0354-032	3.00	32.00	26.00	1.50
626102-0354-033	3.00	33.00	27.00	1.50
626102-0354-034	3.00	34.00	28.00	1.50
626102-0354-035	3.00	35.00	29.00	1.50



Article-No.	DK	L	ML	DS
626102-0354-036	3.00	36.00	30.00	1.50
626102-0354-037	3.00	37.00	31.00	1.50
626102-0354-038	3.00	38.00	32.00	1.50
626102-0354-039	3.00	39.00	33.00	1.50
626102-0354-040	3.00	40.00	34.00	1.50
626112-0300-040	3.00	40.00	35.00	2.00
626102-0354-041	3.00	41.00	35.00	1.50
626102-0354-042	3.00	42.00	36.00	1.50
626112-0300-042	3.00	42.00	34.00	2.00
626102-0354-043	3.00	43.00	37.00	1.50
626102-0354-044	3.00	44.00	38.00	1.50
626102-0354-045	3.00	45.00	39.00	1.50
626102-0354-046	3.00	46.00	40.00	1.50
626102-0354-047	3.00	47.00	41.00	1.50
626102-0354-048	3.00	48.00	42.00	1.50
626102-0354-049	3.00	49.00	43.00	1.50
626102-0354-050	3.00	50.00	44.00	1.50
626102-0354-051	3.00	51.00	45.00	1.50
626112-0300-052	3.00	51.50	44.00	2.00
626102-0354-052	3.00	52.00	46.00	1.50
626102-0354-053	3.00	53.00	47.00	1.50
626102-0354-054	3.00	54.00	48.00	1.50
626102-0354-055	3.00	55.00	49.00	1.50
626102-0354-056	3.00	56.00	50.00	1.50
000000-1234-946	3.00	56.50	51.00	1.50
626102-0354-057	3.00	57.00	51.00	1.50
626102-0354-058	3.00	58.00	52.00	1.50
626102-0354-059	3.00	59.00	53.00	1.50
626102-0354-060	3.00	60.00	54.00	1.50
626112-0300-067	3.00	66.50	60.00	1.50
626112-0300-080	3.00	80.00	75.00	2.00
626102-0454-010	4.00	10.00	4.00	1.50
626102-0454-011	4.00	11.00	5.00	1.50
602030-8015-000	4.00	12.00	6.00	2.00
626102-0454-012	4.00	12.00	6.00	1.50
626102-0454-013	4.00	13.00	7.00	1.50
626102-0454-014	4.00	14.00	8.00	1.50
626102-0454-015	4.00	15.00	9.00	1.50
626102-0454-016	4.00	16.00	10.00	1.50
626102-0454-017	4.00	17.00	11.00	1.50
626102-0454-018	4.00	18.00	12.00	1.50
626102-0454-019	4.00	19.00	13.00	1.50
626102-0454-020	4.00	20.00	14.00	1.50
626102-0454-021	4.00	21.00	15.00	1.50
602030-8016-000	4.00	22.00	16.00	2.00
626102-0454-022	4.00	22.00	16.00	1.50
626112-0400-022	4.00	22.00	14.00	1.50
626102-0454-023	4.00	23.00	17.00	1.50
626102-0454-024	4.00	24.00	18.00	1.50
626102-0454-025	4.00	25.00	19.00	1.50
626102-0454-026	4.00	26.00	20.00	1.50



<b>Article-No.</b>	<b>DK</b>	<b>L</b>	<b>ML</b>	<b>DS</b>
626102-0454-027	4.00	27.00	21.00	1.50
626102-0454-028	4.00	28.00	22.00	1.50
626102-0454-029	4.00	29.00	23.00	1.50
626102-0454-030	4.00	30.00	24.00	1.50
626102-0454-031	4.00	31.00	25.00	1.50
626102-0454-032	4.00	32.00	26.00	1.50
626112-0401-032	4.00	32.00	26.50	2.00
626102-0454-033	4.00	33.00	27.00	1.50
626102-0454-034	4.00	34.00	28.00	1.50
626102-0454-035	4.00	35.00	29.00	1.50
626112-0402-035	4.00	35.00	30.00	2.00
626102-0454-036	4.00	36.00	30.00	1.50
626102-0454-037	4.00	37.00	31.00	1.50
626102-0454-038	4.00	38.00	32.00	1.50
626102-0454-039	4.00	39.00	33.00	1.50
626102-0454-040	4.00	40.00	34.00	1.50
626102-0454-041	4.00	41.00	35.00	1.50
626102-0454-042	4.00	42.00	36.00	1.50
626120-0067-000	4.00	42.00	36.00	2.00
626102-0454-043	4.00	43.00	37.00	1.50
626102-0454-044	4.00	44.00	38.00	1.50
626102-0454-045	4.00	45.00	39.00	1.50
626102-0454-046	4.00	46.00	40.00	1.50
626102-0454-047	4.00	47.00	41.00	1.50
626102-0454-048	4.00	48.00	42.00	1.50
626102-0454-049	4.00	49.00	43.00	1.50
626102-0454-050	4.00	50.00	44.00	1.50
626112-0400-050	4.00	50.00	44.70	2.00
626102-0454-051	4.00	51.00	45.00	1.50
626102-0454-052	4.00	52.00	46.00	1.50
626112-0401-052	4.00	52.00	46.50	2.00
626102-0454-053	4.00	53.00	47.00	1.50
626102-0454-054	4.00	54.00	48.00	1.50
626102-0454-055	4.00	55.00	49.00	1.50
626112-0400-055	4.00	55.00	47.00	2.00
626102-0454-056	4.00	56.00	50.00	1.50
626102-0454-057	4.00	57.00	51.00	1.50
626102-0454-058	4.00	58.00	52.00	1.50
626102-0454-059	4.00	59.00	53.00	1.50
626102-0454-060	4.00	60.00	54.00	1.50
626112-0500-012	5.00	12.00	6.00	2.00
626112-0500-018	5.00	17.50	12.50	2.00
602030-8034-000	5.00	22.50	16.50	2.00
626112-0500-043	5.00	42.50	35.00	2.00
626120-0072-000	5.00	42.50	35.00	2.50
626112-0500-053	5.00	52.50	46.50	2.00
602030-8017-000	6.00	13.00	7.00	3.00
602030-8018-000	6.00	28.00	20.00	3.00
602030-8019-000	8.00	13.00	13.00	3.00
626112-1001-020	10.00	20.00	13.00	3.00

## M2, Styli straight, silicon nitride sphere, tungsten carbide shaft

Standard Styli suitable for all common measuring tasks. M2 threads are common for Renishaw touch sensors.

Connection Type: M2  
 Shaft Material: Tung. Carb.  
 Stylus Tip Geometry: Sphere  
 Stylus Tip Material: Si. Nitride  
 Ø Body (DG): 3

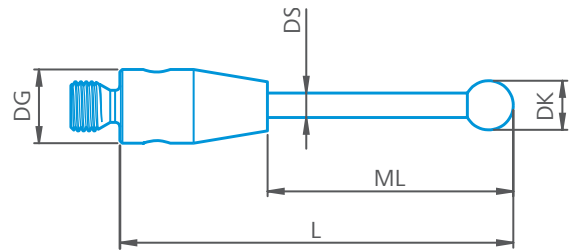

Article-No.	DK	L	ML	DS
626102-5745-009	1.35	9.00	3.00	1.00
626102-5745-010	1.35	10.00	4.00	1.00
626102-5745-011	1.35	11.00	5.00	1.00
626102-5745-012	1.35	12.00	6.00	1.00
626102-5745-013	1.35	13.00	7.00	1.00
626102-5745-014	1.35	14.00	8.00	1.00
626102-5745-015	1.35	15.00	9.00	1.00
626102-5745-016	1.35	16.00	10.00	1.00
626102-5745-017	1.35	17.00	11.00	1.00
626102-5745-018	1.35	18.00	12.00	1.00
626102-5745-019	1.35	19.00	13.00	1.00
626102-5745-020	1.35	20.00	14.00	1.00
626102-5745-021	1.35	21.00	15.00	1.00
626102-5745-022	1.35	22.00	16.00	1.00
626102-5745-023	1.35	23.00	17.00	1.00
626102-5745-024	1.35	24.00	18.00	1.00
626102-5745-025	1.35	25.00	19.00	1.00
626102-5745-026	1.35	26.00	20.00	1.00
626102-5745-027	1.35	27.00	21.00	1.00
626102-5745-028	1.35	28.00	22.00	1.00
626102-5745-029	1.35	29.00	23.00	1.00
626102-5745-030	1.35	30.00	24.00	1.00
626102-5745-031	1.35	31.00	25.00	1.00
626102-5745-032	1.35	32.00	26.00	1.00
626102-5745-033	1.35	33.00	27.00	1.00
626102-5745-034	1.35	34.00	28.00	1.00
626102-5745-035	1.35	35.00	29.00	1.00
626102-5745-036	1.35	36.00	30.00	1.00
626102-5745-037	1.35	37.00	31.00	1.00
626102-5745-038	1.35	38.00	32.00	1.00
626102-5745-039	1.35	39.00	33.00	1.00
626102-5745-040	1.35	40.00	34.00	1.00
626102-5745-041	1.35	41.00	35.00	1.00
626102-5745-042	1.35	42.00	36.00	1.00
626102-5745-043	1.35	43.00	37.00	1.00
626102-5745-044	1.35	44.00	38.00	1.00
626102-5745-045	1.35	45.00	39.00	1.00
626102-0145-009	1.50	9.00	3.00	1.00
626102-0145-010	1.50	10.00	4.00	1.00





Article-No.	DK	L	ML	DS
626102-0145-011	1.50	11.00	5.00	1.00
626102-0145-012	1.50	12.00	6.00	1.00
626102-0145-013	1.50	13.00	7.00	1.00
626102-0145-014	1.50	14.00	8.00	1.00
626102-0145-015	1.50	15.00	9.00	1.00
626102-0145-016	1.50	16.00	10.00	1.00
626102-0145-017	1.50	17.00	11.00	1.00
626102-0145-018	1.50	18.00	12.00	1.00
626102-0145-019	1.50	19.00	13.00	1.00
626102-0145-020	1.50	20.00	14.00	1.00
626102-0145-021	1.50	21.00	15.00	1.00
626102-0145-022	1.50	22.00	16.00	1.00
626102-0145-023	1.50	23.00	17.00	1.00
626102-0145-024	1.50	24.00	18.00	1.00
626102-0145-025	1.50	25.00	19.00	1.00
626102-0145-026	1.50	26.00	20.00	1.00
626102-0145-027	1.50	27.00	21.00	1.00
626102-0145-028	1.50	28.00	22.00	1.00
626102-0145-029	1.50	29.00	23.00	1.00
626102-0145-030	1.50	30.00	24.00	1.00
626102-0145-031	1.50	31.00	25.00	1.00
626102-0145-032	1.50	32.00	26.00	1.00
626102-0145-033	1.50	33.00	27.00	1.00
626102-0145-034	1.50	34.00	28.00	1.00
626102-0145-035	1.50	35.00	29.00	1.00
626102-0145-036	1.50	36.00	30.00	1.00
626102-0145-037	1.50	37.00	31.00	1.00
626102-0145-038	1.50	38.00	32.00	1.00
626102-0145-039	1.50	39.00	33.00	1.00
626102-0145-040	1.50	40.00	34.00	1.00
626102-0145-041	1.50	41.00	35.00	1.00
626102-0145-042	1.50	42.00	36.00	1.00
626102-0145-043	1.50	43.00	37.00	1.00
626102-0145-044	1.50	44.00	38.00	1.00
626102-0145-045	1.50	45.00	39.00	1.00
626102-0255-009	2.00	9.00	3.00	1.50
626102-0245-009	2.00	9.00	3.00	1.00
626102-0255-010	2.00	10.00	4.00	1.50
626102-0245-010	2.00	10.00	4.00	1.00
626102-0255-011	2.00	11.00	5.00	1.50
626102-0245-011	2.00	11.00	5.00	1.00
626102-0255-012	2.00	12.00	6.00	1.50
626102-0245-012	2.00	12.00	6.00	1.00
626102-0255-013	2.00	13.00	7.00	1.50
626102-0245-013	2.00	13.00	7.00	1.00
626102-0245-014	2.00	14.00	8.00	1.00
626102-0255-014	2.00	14.00	8.00	1.50
626102-0245-015	2.00	15.00	9.00	1.00
626102-0255-015	2.00	15.00	9.00	1.50
626102-0245-016	2.00	16.00	10.00	1.00
626102-0255-016	2.00	16.00	10.00	1.50
626102-0245-017	2.00	17.00	11.00	1.00
626102-0255-017	2.00	17.00	11.00	1.50
626102-0245-018	2.00	18.00	12.00	1.00



Article-No.	DK	L	ML	DS
626102-0255-018	2.00	18.00	12.00	1.50
626102-0245-019	2.00	19.00	13.00	1.00
626102-0255-019	2.00	19.00	13.00	1.50
626102-0245-020	2.00	20.00	14.00	1.00
626102-0255-020	2.00	20.00	14.00	1.50
626102-0245-021	2.00	21.00	15.00	1.00
626102-0255-021	2.00	21.00	15.00	1.50
626102-0245-022	2.00	22.00	16.00	1.00
626102-0255-022	2.00	22.00	16.00	1.50
626102-0245-023	2.00	23.00	17.00	1.00
626102-0255-023	2.00	23.00	17.00	1.50
626102-0245-024	2.00	24.00	18.00	1.00
626102-0255-024	2.00	24.00	18.00	1.50
626102-0245-025	2.00	25.00	19.00	1.00
626102-0255-025	2.00	25.00	19.00	1.50
626102-0245-026	2.00	26.00	20.00	1.00
626102-0255-026	2.00	26.00	20.00	1.50
626102-0245-027	2.00	27.00	21.00	1.00
626102-0255-027	2.00	27.00	21.00	1.50
626102-0245-028	2.00	28.00	22.00	1.00
626102-0255-028	2.00	28.00	22.00	1.50
626102-0245-029	2.00	29.00	23.00	1.00
626102-0255-029	2.00	29.00	23.00	1.50
626102-0245-030	2.00	30.00	24.00	1.00
626102-0255-030	2.00	30.00	24.00	1.50
626102-0245-031	2.00	31.00	25.00	1.00
626102-0255-031	2.00	31.00	25.00	1.50
626102-0245-032	2.00	32.00	26.00	1.00
626102-0255-032	2.00	32.00	26.00	1.50
626102-0245-033	2.00	33.00	27.00	1.00
626102-0255-033	2.00	33.00	27.00	1.50
626102-0245-034	2.00	34.00	28.00	1.00
626102-0255-034	2.00	34.00	28.00	1.50
626102-0245-035	2.00	35.00	29.00	1.00
626102-0255-035	2.00	35.00	29.00	1.50
626102-0245-036	2.00	36.00	30.00	1.00
626102-0255-036	2.00	36.00	30.00	1.50
626102-0245-037	2.00	37.00	31.00	1.00
626102-0255-037	2.00	37.00	31.00	1.50
626102-0245-038	2.00	38.00	32.00	1.00
626102-0255-038	2.00	38.00	32.00	1.50
626102-0245-039	2.00	39.00	33.00	1.00
626102-0255-039	2.00	39.00	33.00	1.50
626102-0245-040	2.00	40.00	34.00	1.00
626102-0255-040	2.00	40.00	34.00	1.50
626102-0245-041	2.00	41.00	35.00	1.00
626102-0255-041	2.00	41.00	35.00	1.50
626102-0245-042	2.00	42.00	36.00	1.00
626102-0255-042	2.00	42.00	36.00	1.50
626102-0245-043	2.00	43.00	37.00	1.00
626102-0255-043	2.00	43.00	37.00	1.50



Article-No.	DK	L	ML	DS
626102-0245-044	2.00	44.00	38.00	1.00
626102-0255-044	2.00	44.00	38.00	1.50
626102-0245-045	2.00	45.00	39.00	1.00
626102-0255-045	2.00	45.00	39.00	1.50
626102-0255-046	2.00	46.00	40.00	1.50
626102-0255-047	2.00	47.00	41.00	1.50
626102-0255-048	2.00	48.00	42.00	1.50
626102-0255-049	2.00	49.00	43.00	1.50
626102-0255-050	2.00	50.00	44.00	1.50
626102-0255-051	2.00	51.00	45.00	1.50
626102-0255-052	2.00	52.00	46.00	1.50
626102-0255-053	2.00	53.00	47.00	1.50
626102-0255-054	2.00	54.00	48.00	1.50
626102-0255-055	2.00	55.00	49.00	1.50
626102-0255-056	2.00	56.00	50.00	1.50
626102-0255-057	2.00	57.00	51.00	1.50
626102-0255-058	2.00	58.00	52.00	1.50
626102-0255-059	2.00	59.00	53.00	1.50
626102-0255-060	2.00	60.00	54.00	1.50
626102-5855-009	2.50	9.00	3.00	1.50
626102-5855-010	2.50	10.00	4.00	1.50
626102-5855-011	2.50	11.00	5.00	1.50
626102-5855-012	2.50	12.00	6.00	1.50
626102-5855-013	2.50	13.00	7.00	1.50
626102-5855-014	2.50	14.00	8.00	1.50
626102-5855-015	2.50	15.00	9.00	1.50
626102-5855-016	2.50	16.00	10.00	1.50
626102-5855-017	2.50	17.00	11.00	1.50
626102-5855-018	2.50	18.00	12.00	1.50
626102-5855-019	2.50	19.00	13.00	1.50
626102-5855-020	2.50	20.00	14.00	1.50
626102-5855-021	2.50	21.00	15.00	1.50
626102-5855-022	2.50	22.00	16.00	1.50
626102-5855-023	2.50	23.00	17.00	1.50
626102-5855-024	2.50	24.00	18.00	1.50
626102-5855-025	2.50	25.00	19.00	1.50
626102-5855-026	2.50	26.00	20.00	1.50
626102-5855-027	2.50	27.00	21.00	1.50
626102-5855-028	2.50	28.00	22.00	1.50
626102-5855-029	2.50	29.00	23.00	1.50
626102-5855-030	2.50	30.00	24.00	1.50
626102-5855-031	2.50	31.00	25.00	1.50
626102-5855-032	2.50	32.00	26.00	1.50
626102-5855-033	2.50	33.00	27.00	1.50
626102-5855-034	2.50	34.00	28.00	1.50
626102-5855-035	2.50	35.00	29.00	1.50
626102-5855-036	2.50	36.00	30.00	1.50
626102-5855-037	2.50	37.00	31.00	1.50
626102-5855-038	2.50	38.00	32.00	1.50
626102-5855-039	2.50	39.00	33.00	1.50
626102-5855-040	2.50	40.00	34.00	1.50
626102-5855-041	2.50	41.00	35.00	1.50
626102-5855-042	2.50	42.00	36.00	1.50
626102-5855-043	2.50	43.00	37.00	1.50



Article-No.	DK	L	ML	DS
626102-5855-044	2.50	44.00	38.00	1.50
626102-5855-045	2.50	45.00	39.00	1.50
626102-5855-046	2.50	46.00	40.00	1.50
626102-5855-047	2.50	47.00	41.00	1.50
626102-5855-048	2.50	48.00	42.00	1.50
626102-5855-049	2.50	49.00	43.00	1.50
626102-5855-050	2.50	50.00	44.00	1.50
626102-5855-051	2.50	51.00	45.00	1.50
626102-5855-052	2.50	52.00	46.00	1.50
626102-5855-053	2.50	53.00	47.00	1.50
626102-5855-054	2.50	54.00	48.00	1.50
626102-5855-055	2.50	55.00	49.00	1.50
626102-5855-056	2.50	56.00	50.00	1.50
626102-5855-057	2.50	57.00	51.00	1.50
626102-5855-058	2.50	58.00	52.00	1.50
626102-5855-059	2.50	59.00	53.00	1.50
626102-5855-060	2.50	60.00	54.00	1.50
626102-0355-009	3.00	9.00	3.00	1.50
626102-0355-010	3.00	10.00	4.00	1.50
626102-0355-011	3.00	11.00	5.00	1.50
626102-0355-012	3.00	12.00	6.00	1.50
626102-0355-013	3.00	13.00	7.00	1.50
626102-0355-014	3.00	14.00	8.00	1.50
626102-0355-015	3.00	15.00	9.00	1.50
626102-0355-016	3.00	16.00	10.00	1.50
626102-0355-017	3.00	17.00	11.00	1.50
626102-0355-018	3.00	18.00	12.00	1.50
626102-0355-019	3.00	19.00	13.00	1.50
626102-0355-020	3.00	20.00	14.00	1.50
626102-0355-021	3.00	21.00	15.00	1.50
626102-0355-022	3.00	22.00	16.00	1.50
626102-0355-023	3.00	23.00	17.00	1.50
626102-0355-024	3.00	24.00	18.00	1.50
626102-0355-025	3.00	25.00	19.00	1.50
626102-0355-026	3.00	26.00	20.00	1.50
626102-0355-027	3.00	27.00	21.00	1.50
626102-0355-028	3.00	28.00	22.00	1.50
626102-0355-029	3.00	29.00	23.00	1.50
626102-0355-030	3.00	30.00	24.00	1.50
626102-0355-031	3.00	31.00	25.00	1.50
626102-0355-032	3.00	32.00	26.00	1.50
626102-0355-033	3.00	33.00	27.00	1.50
626102-0355-034	3.00	34.00	28.00	1.50
626102-0355-035	3.00	35.00	29.00	1.50
626102-0355-036	3.00	36.00	30.00	1.50
626102-0355-037	3.00	37.00	31.00	1.50
626102-0355-038	3.00	38.00	32.00	1.50
626102-0355-039	3.00	39.00	33.00	1.50
626102-0355-040	3.00	40.00	34.00	1.50
626102-0355-041	3.00	41.00	35.00	1.50
626102-0355-042	3.00	42.00	36.00	1.50



<b>Article-No.</b>	<b>DK</b>	<b>L</b>	<b>ML</b>	<b>DS</b>
626102-0355-043	3.00	43.00	37.00	1.50
626102-0355-044	3.00	44.00	38.00	1.50
626102-0355-045	3.00	45.00	39.00	1.50
626102-0455-010	4.00	10.00	4.00	1.50
626102-0455-011	4.00	11.00	5.00	1.50
626102-0455-012	4.00	12.00	6.00	1.50
626102-0455-013	4.00	13.00	7.00	1.50
626102-0455-014	4.00	14.00	8.00	1.50
626102-0455-015	4.00	15.00	9.00	1.50
626102-0455-016	4.00	16.00	10.00	1.50
626102-0455-017	4.00	17.00	11.00	1.50
626102-0455-018	4.00	18.00	12.00	1.50
626102-0455-019	4.00	19.00	13.00	1.50
626102-0455-020	4.00	20.00	14.00	1.50
626102-0455-021	4.00	21.00	15.00	1.50
626102-0455-022	4.00	22.00	16.00	1.50
626102-0455-023	4.00	23.00	17.00	1.50
626102-0455-024	4.00	24.00	18.00	1.50
626102-0455-025	4.00	25.00	19.00	1.50
626102-0455-026	4.00	26.00	20.00	1.50
626102-0455-027	4.00	27.00	21.00	1.50
626102-0455-028	4.00	28.00	22.00	1.50
626102-0455-029	4.00	29.00	23.00	1.50
626102-0455-030	4.00	30.00	24.00	1.50
626102-0455-031	4.00	31.00	25.00	1.50
626102-0455-032	4.00	32.00	26.00	1.50
626102-0455-033	4.00	33.00	27.00	1.50
626102-0455-034	4.00	34.00	28.00	1.50
626102-0455-035	4.00	35.00	29.00	1.50
626102-0455-036	4.00	36.00	30.00	1.50
626102-0455-037	4.00	37.00	31.00	1.50
626102-0455-038	4.00	38.00	32.00	1.50
626102-0455-039	4.00	39.00	33.00	1.50
626102-0455-040	4.00	40.00	34.00	1.50
626102-0455-041	4.00	41.00	35.00	1.50
626102-0455-042	4.00	42.00	36.00	1.50
626102-0455-043	4.00	43.00	37.00	1.50
626102-0455-044	4.00	44.00	38.00	1.50
626102-0455-045	4.00	45.00	39.00	1.50
626102-0455-046	4.00	46.00	40.00	1.50
626102-0455-047	4.00	47.00	41.00	1.50
626102-0455-048	4.00	48.00	42.00	1.50
626102-0455-049	4.00	49.00	43.00	1.50
626102-0455-050	4.00	50.00	44.00	1.50
626102-0455-051	4.00	51.00	45.00	1.50
626102-0455-052	4.00	52.00	46.00	1.50
626102-0455-053	4.00	53.00	47.00	1.50
626102-0455-054	4.00	54.00	48.00	1.50
626102-0455-055	4.00	55.00	49.00	1.50
626102-0455-056	4.00	56.00	50.00	1.50
626102-0455-057	4.00	57.00	51.00	1.50
626102-0455-058	4.00	58.00	52.00	1.50
626102-0455-059	4.00	59.00	53.00	1.50
626102-0455-060	4.00	60.00	54.00	1.50

## M2, Styli stepped, ruby sphere, tungsten carbide shaft

Standard Styli suitable for all common measuring tasks. M2 threads are common for Renishaw touch sensors.

Connection Type: M2  
 Shaft Material: Tung. Carb.  
 Stylus Tip Geometry: Sphere  
 Stylus Tip Material: Ruby  
 Ø Body (DG): 3

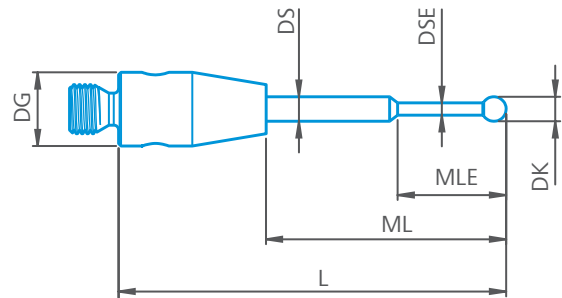

Article-No.	DK	L	ML	DS	MLE	DSE
626102-5144-009	0.20	9.00	3.00	1.00	3.00	0.15
626102-5144-010	0.20	10.00	4.00	1.00	3.00	0.15
626112-0020-010	0.20	10.00	6.00	1.00	2.20	0.15
626102-5144-011	0.20	11.00	5.00	1.00	3.00	0.15
626102-5144-012	0.20	12.00	6.00	1.00	3.00	0.15
626102-5144-013	0.20	13.00	7.00	1.00	3.00	0.15
626102-5144-014	0.20	14.00	8.00	1.00	3.00	0.15
626102-5144-015	0.20	15.00	9.00	1.00	3.00	0.15
626102-5144-016	0.20	16.00	10.00	1.00	3.00	0.15
626102-5144-017	0.20	17.00	11.00	1.00	3.00	0.15
626102-5144-018	0.20	18.00	12.00	1.00	3.00	0.15
626102-5144-019	0.20	19.00	13.00	1.00	3.00	0.15
626102-5144-020	0.20	20.00	14.00	1.00	3.00	0.15
626102-5144-021	0.20	21.00	15.00	1.00	3.00	0.15
626102-5144-022	0.20	22.00	16.00	1.00	3.00	0.15
626102-5144-023	0.20	23.00	17.00	1.00	3.00	0.15
626102-5144-024	0.20	24.00	18.00	1.00	3.00	0.15
626102-5144-025	0.20	25.00	19.00	1.00	3.00	0.15
626112-0020-026	0.25	26.00	20.00	1.00	2.50	0.20
626102-5244-009	0.30	9.00	3.00	1.00	2.30	0.20
626102-5244-010	0.30	10.00	4.00	1.00	2.30	0.20
626120-0017-000	0.30	10.15	4.65	0.70	2.15	0.20
626102-5244-011	0.30	11.00	5.00	1.00	2.30	0.20
626102-5244-012	0.30	12.00	6.00	1.00	2.30	0.20
626102-5244-013	0.30	13.00	7.00	1.00	2.30	0.20
626102-5244-014	0.30	14.00	8.00	1.00	2.30	0.20
626102-5244-015	0.30	15.00	9.00	1.00	2.30	0.20
626102-5244-016	0.30	16.00	10.00	1.00	2.30	0.20
626102-5244-017	0.30	17.00	11.00	1.00	2.30	0.20
626102-5244-018	0.30	18.00	12.00	1.00	2.30	0.20
626112-0030-018	0.30	18.00	13.00	1.00	2.30	0.20
626102-5244-019	0.30	19.00	13.00	1.00	2.30	0.20
626102-5244-020	0.30	20.00	14.00	1.00	2.30	0.20
626102-5244-021	0.30	21.00	15.00	1.00	2.30	0.20
626102-5244-022	0.30	22.00	16.00	1.00	2.30	0.20
626102-5244-023	0.30	23.00	17.00	1.00	2.30	0.20
626102-5244-024	0.30	24.00	18.00	1.00	2.30	0.20
626102-5244-025	0.30	25.00	19.00	1.00	2.30	0.20



Article-No.	DK	L	ML	DS	MLE	DSE
626102-5344-009	0.40	9.00	3.00	1.00	2.30	0.30
626102-5344-010	0.40	10.00	4.00	1.00	2.30	0.30
626102-5344-011	0.40	11.00	5.00	1.00	2.30	0.30
626102-5344-012	0.40	12.00	6.00	1.00	2.30	0.30
626102-5344-013	0.40	13.00	7.00	1.00	2.30	0.30
626102-5344-014	0.40	14.00	8.00	1.00	2.30	0.30
626102-5344-015	0.40	15.00	9.00	1.00	2.30	0.30
626102-5344-016	0.40	16.00	10.00	1.00	2.30	0.30
626102-5344-017	0.40	17.00	11.00	1.00	2.30	0.30
626102-5344-018	0.40	18.00	12.00	1.00	2.30	0.30
626102-5344-019	0.40	19.00	13.00	1.00	2.30	0.30
626102-5344-020	0.40	20.00	14.00	1.00	2.30	0.30
626102-5344-021	0.40	21.00	15.00	1.00	2.30	0.30
626102-5344-022	0.40	22.00	16.00	1.00	2.30	0.30
626102-5344-023	0.40	23.00	17.00	1.00	2.30	0.30
626102-5344-024	0.40	24.00	18.00	1.00	2.30	0.30
626102-5344-025	0.40	25.00	19.00	1.00	2.30	0.30
626102-5444-009	0.50	9.00	3.00	1.00	2.50	0.30
626102-5444-010	0.50	10.00	4.00	1.00	2.50	0.30
626112-0050-010	0.50	10.00	6.00	1.00	2.50	0.30
623062-3132-000	0.50	10.25	4.25	0.70	3.25	0.40
626102-5444-011	0.50	11.00	5.00	1.00	2.50	0.30
626102-5444-012	0.50	12.00	6.00	1.00	2.50	0.30
626112-0050-013	0.50	13.00	7.00	1.00	2.50	0.30
626102-5444-013	0.50	13.00	7.00	1.00	2.50	0.30
626102-5444-014	0.50	14.00	8.00	1.00	2.50	0.30
626102-5444-015	0.50	15.00	9.00	1.00	2.50	0.30
626112-0051-015	0.50	15.25	10.25	1.00	2.30	0.30
626102-5444-016	0.50	16.00	10.00	1.00	2.50	0.30
626102-5444-017	0.50	17.00	11.00	1.00	2.50	0.30
626102-5444-018	0.50	18.00	12.00	1.00	2.50	0.30
626102-5444-019	0.50	19.00	13.00	1.00	2.50	0.30
626112-0052-020	0.50	20.00	14.00	1.00	2.50	0.30
626102-5444-020	0.50	20.00	14.00	1.00	2.50	0.30
626102-5444-021	0.50	21.00	15.00	1.00	2.50	0.30
626102-5444-022	0.50	22.00	16.00	1.00	2.50	0.30
626112-0050-022	0.50	22.00	17.00	1.00	5.00	0.35
626102-5444-023	0.50	23.00	17.00	1.00	2.50	0.30
626102-5444-024	0.50	24.00	18.00	1.00	2.50	0.30
626102-5444-025	0.50	25.00	19.00	1.00	2.50	0.30
626112-0050-025	0.50	25.00	19.00	1.00	5.00	0.30
626102-5544-011	0.60	11.00	5.00	1.00	4.60	0.40
626102-5544-012	0.60	12.00	6.00	1.00	4.60	0.40
626102-5544-013	0.60	13.00	7.00	1.00	4.60	0.40
626112-0060-014	0.60	14.00	8.00	1.00	4.60	0.40
626102-5544-014	0.60	14.00	8.00	1.00	4.60	0.40
626102-5544-015	0.60	15.00	9.00	1.00	4.60	0.40
626102-5544-016	0.60	16.00	10.00	1.00	4.60	0.40
626102-5544-017	0.60	17.00	11.00	1.00	4.60	0.40
626102-5544-018	0.60	18.00	12.00	1.00	4.60	0.40
626102-5544-019	0.60	19.00	13.00	1.00	4.60	0.40
626102-5544-020	0.60	20.00	14.00	1.00	4.60	0.40
626102-5544-021	0.60	21.00	15.00	1.00	4.60	0.40
626102-5544-022	0.60	22.00	16.00	1.00	4.60	0.40



Article-No.	DK	L	ML	DS	MLE	DSE
626102-5544-023	0.60	23.00	17.00	1.00	4.60	0.40
626102-5544-024	0.60	24.00	18.00	1.00	4.60	0.40
626102-5544-025	0.60	25.00	19.00	1.00	4.60	0.40
626102-5644-011	0.80	11.00	5.00	1.00	4.80	0.60
626102-5644-012	0.80	12.00	6.00	1.00	4.80	0.60
626102-5644-013	0.80	13.00	7.00	1.00	4.80	0.60
626102-5644-014	0.80	14.00	8.00	1.00	4.80	0.60
626102-5644-015	0.80	15.00	9.00	1.00	4.80	0.60
626102-5644-016	0.80	16.00	10.00	1.00	4.80	0.60
626112-0080-016	0.80	16.40	10.40	1.00	4.80	0.60
626102-5644-017	0.80	17.00	11.00	1.00	4.80	0.60
626102-5644-018	0.80	18.00	12.00	1.00	4.80	0.60
626102-5644-019	0.80	19.00	13.00	1.00	4.80	0.60
626102-5644-020	0.80	20.00	14.00	1.00	4.80	0.60
626102-5644-021	0.80	21.00	15.00	1.00	4.80	0.60
626102-5644-022	0.80	22.00	16.00	1.00	4.80	0.60
626102-5644-023	0.80	23.00	17.00	1.00	4.80	0.60
626102-5644-024	0.80	24.00	18.00	1.00	4.80	0.60
626102-5644-025	0.80	25.00	19.00	1.00	4.80	0.60
626102-5644-026	0.80	26.00	20.00	1.00	4.80	0.60
626102-5644-027	0.80	27.00	21.00	1.00	4.80	0.60
626102-5644-028	0.80	28.00	22.00	1.00	4.80	0.60
626102-5644-029	0.80	29.00	23.00	1.00	4.80	0.60
626102-5644-030	0.80	30.00	24.00	1.00	4.80	0.60
626102-5644-031	0.80	31.00	25.00	1.00	4.80	0.60
626102-5644-032	0.80	32.00	26.00	1.00	4.80	0.60
626102-5644-033	0.80	33.00	27.00	1.00	4.80	0.60
626102-5644-034	0.80	34.00	28.00	1.00	4.80	0.60
626102-5644-035	0.80	35.00	29.00	1.00	4.80	0.60
626102-0044-011	1.00	11.00	5.00	1.00	5.00	0.80
626102-0044-012	1.00	12.00	6.00	1.00	5.00	0.80
626102-0044-013	1.00	13.00	7.00	1.00	5.00	0.80
626102-0044-014	1.00	14.00	8.00	1.00	5.00	0.80
626102-0044-015	1.00	15.00	9.00	1.00	5.00	0.80
626112-0101-016	1.00	15.50	10.50	1.00	5.00	0.80
626102-0044-016	1.00	16.00	10.00	1.00	5.00	0.80
626102-0044-017	1.00	17.00	11.00	1.00	5.00	0.80
626102-0044-018	1.00	18.00	12.00	1.00	5.00	0.80
626102-0044-019	1.00	19.00	13.00	1.00	5.00	0.80
626102-0044-020	1.00	20.00	14.00	1.00	5.00	0.80
626102-0044-021	1.00	21.00	15.00	1.00	5.00	0.80
626112-0100-022	1.00	21.50	16.50	1.00	7.00	0.80
626102-0044-022	1.00	22.00	16.00	1.00	5.00	0.80
626102-0044-023	1.00	23.00	17.00	1.00	5.00	0.80
626102-0044-024	1.00	24.00	18.00	1.00	5.00	0.80
626102-0044-025	1.00	25.00	19.00	1.00	5.00	0.80
626102-0044-026	1.00	26.00	20.00	1.00	5.00	0.80
626102-0044-027	1.00	27.00	21.00	1.00	5.00	0.80
626102-0044-028	1.00	28.00	22.00	1.00	5.00	0.80
626102-0044-029	1.00	29.00	23.00	1.00	5.00	0.80
626102-0044-030	1.00	30.00	24.00	1.00	5.00	0.80





Article-No.	DK	L	ML	DS	MLE	DSE
626112-0101-030	1.00	30.00	22.00	1.50	5.00	0.80
626112-0100-030	1.00	30.00	25.00	1.50	10.00	0.70
626102-0044-031	1.00	31.00	25.00	1.00	5.00	0.80
626102-0044-032	1.00	32.00	26.00	1.00	5.00	0.80
626102-0044-033	1.00	33.00	27.00	1.00	5.00	0.80
626102-0044-034	1.00	34.00	28.00	1.00	5.00	0.80
626102-0044-035	1.00	35.00	29.00	1.00	5.00	0.80
626102-0044-036	1.00	36.00	30.00	1.00	5.00	0.80
626102-0044-037	1.00	37.00	31.00	1.00	5.00	0.80
626102-0044-038	1.00	38.00	32.00	1.00	5.00	0.80
626102-0044-039	1.00	39.00	33.00	1.00	5.00	0.80
626102-0044-040	1.00	40.00	34.00	1.00	5.00	0.80
626102-0044-041	1.00	41.00	35.00	1.00	5.00	0.80
626102-0044-042	1.00	42.00	36.00	1.00	5.00	0.80
626102-0044-043	1.00	43.00	37.00	1.00	5.00	0.80
626102-0044-044	1.00	44.00	38.00	1.00	5.00	0.80
626102-0044-045	1.00	45.00	39.00	1.00	5.00	0.80
626112-0201-025	2.00	25.00	19.00	2.00	3.25	1.00
626112-0200-040	2.00	40.00	35.00	2.00	3.20	1.00

## M2, Styli stepped, silicon nitride sphere, tungsten carbide shaft

Standard Styli suitable for all common measuring tasks. M2 threads are common for Renishaw touch sensors.

Connection Type: M2  
 Shaft Material: Tung. Carb.  
 Stylus Tip Geometry: Sphere  
 Stylus Tip Material: Si. Nitride  
 Ø Body (DG): 3

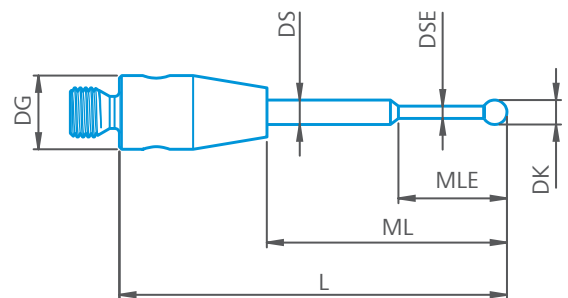

Article-No.	DK	L	ML	DS	MLE	DSE
626102-5245-009	0.30	9.00	3.00	1.00	2.30	0.20
626102-5245-010	0.30	10.00	4.00	1.00	2.30	0.20
626102-5245-011	0.30	11.00	5.00	1.00	2.30	0.20
626102-5245-012	0.30	12.00	6.00	1.00	2.30	0.20
626102-5245-013	0.30	13.00	7.00	1.00	2.30	0.20
626102-5245-014	0.30	14.00	8.00	1.00	2.30	0.20
626102-5245-015	0.30	15.00	9.00	1.00	2.30	0.20
626102-5245-016	0.30	16.00	10.00	1.00	2.30	0.20
626102-5245-017	0.30	17.00	11.00	1.00	2.30	0.20
626102-5245-018	0.30	18.00	12.00	1.00	2.30	0.20
626102-5245-019	0.30	19.00	13.00	1.00	2.30	0.20
626102-5245-020	0.30	20.00	14.00	1.00	2.30	0.20
626102-5245-021	0.30	21.00	15.00	1.00	2.30	0.20
626102-5245-022	0.30	22.00	16.00	1.00	2.30	0.20
626102-5245-023	0.30	23.00	17.00	1.00	2.30	0.20
626102-5245-024	0.30	24.00	18.00	1.00	2.30	0.20
626102-5245-025	0.30	25.00	19.00	1.00	2.30	0.20
626102-5445-009	0.50	9.00	3.00	1.00	2.50	0.30
626102-5445-010	0.50	10.00	4.00	1.00	2.50	0.30
626102-5445-011	0.50	11.00	5.00	1.00	2.50	0.30



Article-No.	DK	L	ML	DS	MLE	DSE
626102-5445-012	0.50	12.00	6.00	1.00	2.50	0.30
626102-5445-013	0.50	13.00	7.00	1.00	2.50	0.30
626102-5445-014	0.50	14.00	8.00	1.00	2.50	0.30
626102-5445-015	0.50	15.00	9.00	1.00	2.50	0.30
626102-5445-016	0.50	16.00	10.00	1.00	2.50	0.30
626102-5445-017	0.50	17.00	11.00	1.00	2.50	0.30
626102-5445-018	0.50	18.00	12.00	1.00	2.50	0.30
626102-5445-019	0.50	19.00	13.00	1.00	2.50	0.30
626102-5445-020	0.50	20.00	14.00	1.00	2.50	0.30
626102-5445-021	0.50	21.00	15.00	1.00	2.50	0.30
626102-5445-022	0.50	22.00	16.00	1.00	2.50	0.30
626102-5445-023	0.50	23.00	17.00	1.00	2.50	0.30
626102-5445-024	0.50	24.00	18.00	1.00	2.50	0.30
626102-5445-025	0.50	25.00	19.00	1.00	2.50	0.30
626102-5545-011	0.60	11.00	5.00	1.00	4.60	0.40
626102-5545-012	0.60	12.00	6.00	1.00	4.60	0.40
626102-5545-013	0.60	13.00	7.00	1.00	4.60	0.40
626102-5545-014	0.60	14.00	8.00	1.00	4.60	0.40
626102-5545-015	0.60	15.00	9.00	1.00	4.60	0.40
626102-5545-016	0.60	16.00	10.00	1.00	4.60	0.40
626102-5545-017	0.60	17.00	11.00	1.00	4.60	0.40
626102-5545-018	0.60	18.00	12.00	1.00	4.60	0.40
626102-5545-019	0.60	19.00	13.00	1.00	4.60	0.40
626102-5545-020	0.60	20.00	14.00	1.00	4.60	0.40
626102-5545-021	0.60	21.00	15.00	1.00	4.60	0.40
626102-5545-022	0.60	22.00	16.00	1.00	4.60	0.40
626102-5545-023	0.60	23.00	17.00	1.00	4.60	0.40
626102-5545-024	0.60	24.00	18.00	1.00	4.60	0.40
626102-5545-025	0.60	25.00	19.00	1.00	4.60	0.40
626102-5645-011	0.80	11.00	5.00	1.00	4.80	0.60
626102-5645-012	0.80	12.00	6.00	1.00	4.80	0.60
626102-5645-013	0.80	13.00	7.00	1.00	4.80	0.60
626102-5645-014	0.80	14.00	8.00	1.00	4.80	0.60
626102-5645-015	0.80	15.00	9.00	1.00	4.80	0.60
626102-5645-016	0.80	16.00	10.00	1.00	4.80	0.60
626102-5645-017	0.80	17.00	11.00	1.00	4.80	0.60
626102-5645-018	0.80	18.00	12.00	1.00	4.80	0.60
626102-5645-019	0.80	19.00	13.00	1.00	4.80	0.60
626102-5645-020	0.80	20.00	14.00	1.00	4.80	0.60
626102-5645-021	0.80	21.00	15.00	1.00	4.80	0.60
626102-5645-022	0.80	22.00	16.00	1.00	4.80	0.60
626102-5645-023	0.80	23.00	17.00	1.00	4.80	0.60
626102-5645-024	0.80	24.00	18.00	1.00	4.80	0.60
626102-5645-025	0.80	25.00	19.00	1.00	4.80	0.60
626102-5645-026	0.80	26.00	20.00	1.00	4.80	0.60
626102-5645-027	0.80	27.00	21.00	1.00	4.80	0.60
626102-5645-028	0.80	28.00	22.00	1.00	4.80	0.60
626102-5645-029	0.80	29.00	23.00	1.00	4.80	0.60
626102-5645-030	0.80	30.00	24.00	1.00	4.80	0.60
626102-5645-031	0.80	31.00	25.00	1.00	4.80	0.60
626102-5645-032	0.80	32.00	26.00	1.00	4.80	0.60



Article-No.	DK	L	ML	DS	MLE	DSE
626102-5645-033	0.80	33.00	27.00	1.00	4.80	0.60
626102-5645-034	0.80	34.00	28.00	1.00	4.80	0.60
626102-5645-035	0.80	35.00	29.00	1.00	4.80	0.60
626102-5645-036	0.80	36.00	30.00	1.00	4.80	0.60
626102-5645-037	0.80	37.00	31.00	1.00	4.80	0.60
626102-5645-038	0.80	38.00	32.00	1.00	4.80	0.60
626102-5645-039	0.80	39.00	33.00	1.00	4.80	0.60
626102-5645-040	0.80	40.00	34.00	1.00	4.80	0.60
626102-0045-011	1.00	11.00	5.00	1.00	5.00	0.80
626102-0045-012	1.00	12.00	6.00	1.00	5.00	0.80
626102-0045-013	1.00	13.00	7.00	1.00	5.00	0.80
626102-0045-014	1.00	14.00	8.00	1.00	5.00	0.80
626102-0045-015	1.00	15.00	9.00	1.00	5.00	0.80
626102-0045-016	1.00	16.00	10.00	1.00	5.00	0.80
626102-0045-017	1.00	17.00	11.00	1.00	5.00	0.80
626102-0045-018	1.00	18.00	12.00	1.00	5.00	0.80
626102-0045-019	1.00	19.00	13.00	1.00	5.00	0.80
626102-0045-020	1.00	20.00	14.00	1.00	5.00	0.80
626102-0045-021	1.00	21.00	15.00	1.00	5.00	0.80
626102-0045-022	1.00	22.00	16.00	1.00	5.00	0.80
626102-0045-023	1.00	23.00	17.00	1.00	5.00	0.80
626102-0045-024	1.00	24.00	18.00	1.00	5.00	0.80
626102-0045-025	1.00	25.00	19.00	1.00	5.00	0.80
626102-0045-026	1.00	26.00	20.00	1.00	5.00	0.80
626102-0045-027	1.00	27.00	21.00	1.00	5.00	0.80
626102-0045-028	1.00	28.00	22.00	1.00	5.00	0.80
626102-0045-029	1.00	29.00	23.00	1.00	5.00	0.80
626102-0045-030	1.00	30.00	24.00	1.00	5.00	0.80
626102-0045-031	1.00	31.00	25.00	1.00	5.00	0.80
626102-0045-032	1.00	32.00	26.00	1.00	5.00	0.80
626102-0045-033	1.00	33.00	27.00	1.00	5.00	0.80
626102-0045-034	1.00	34.00	28.00	1.00	5.00	0.80
626102-0045-035	1.00	35.00	29.00	1.00	5.00	0.80
626102-0045-036	1.00	36.00	30.00	1.00	5.00	0.80
626102-0045-037	1.00	37.00	31.00	1.00	5.00	0.80
626102-0045-038	1.00	38.00	32.00	1.00	5.00	0.80
626102-0045-039	1.00	39.00	33.00	1.00	5.00	0.80
626102-0045-040	1.00	40.00	34.00	1.00	5.00	0.80
626102-0045-041	1.00	41.00	35.00	1.00	5.00	0.80
626102-0045-042	1.00	42.00	36.00	1.00	5.00	0.80
626102-0045-043	1.00	43.00	37.00	1.00	5.00	0.80
626102-0045-044	1.00	44.00	38.00	1.00	5.00	0.80
626102-0045-045	1.00	45.00	39.00	1.00	5.00	0.80

## Cylinder styli

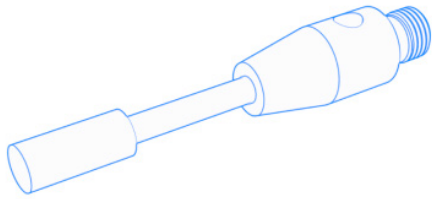

Cylindrical styli measure two-dimensionally and are particularly suitable for thin sheets. Narrow workpiece edges can also be measured well with cylindrical measuring probes. However, the probe axis must be mechanically aligned very precisely with the feature axis on the workpiece. As a special form, spherical cylindrical styli are available, which are also mostly used for sheet metal measurement and measurement at sheet metal edges. They have spherical end and can thus additionally determine the flatness of a surface, for example.

### M2, cylinder styli, cylinder tungsten carbide, tungsten carbide shaft

Cylindrical styli for thin sheets and narrow workpiece edges. M2 threads are common for Renishaw touch sensors.

Connection Type: M2  
 Shaft Material: Tung. Carb.  
 Stylus Tip Geometry: Cylinder  
 Stylus Tip Material: Tung. Carb.  
 Ø Body (DG): 3

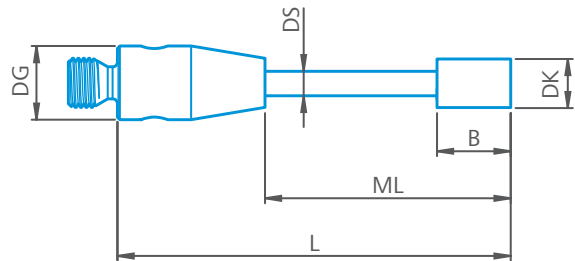

Article-No.	DK	L	ML	DS	B
602030-8096-000	1.50	11.00	5.50	1.00	1.50
626112-0152-041	1.50	41.00	36.00	1.00	7.00
602030-8098-000	3.00	13.00	7.00	1.50	4.00
626112-0500-020	5.00	20.00	16.00	2.00	5.00

### M2, cylinder styli, tungsten carbide cylinder, without shaft

Cylindrical styli for thin sheets and narrow workpiece edges. M2 threads are common for Renishaw touch sensors.

Connection Type: M2  
 Shaft Material: Tung. Carb.  
 Stylus Tip Geometry: Cylinder  
 Stylus Tip Material: Tung. Carb.  
 Ø Body (DG): 3

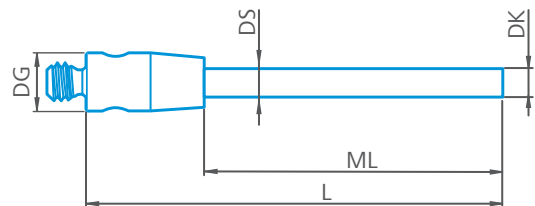

Article-No.	DK	L	ML	DS	B
626112-0053-015	0.50	15.00	10.00	0.50	0.50
626112-0153-012	1.50	11.70	5.70	1.50	5.70

## M2, Spherical cylinder styli, ruby Spherical cylinder, tungsten carbide shaft

Cylindrical styli for thin sheets and narrow workpiece edges. In addition surface measurement with the spherical tip. M2 threads are common for Renishaw touch sensors.

Connection Type: M2  
 Shaft Material: Tung. Carb.  
 Stylus Tip Geometry: Spherical Cylinder  
 Stylus Tip Material: Ruby  
 Ø Body (DG): 3

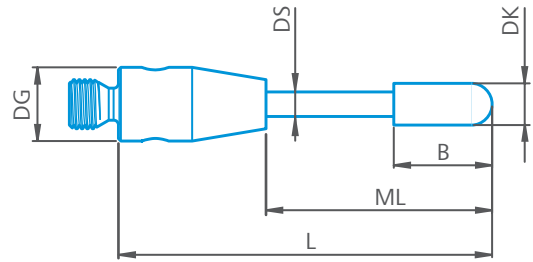

Article-No.	DK	L	ML	DS	B
602030-8100-000	2.00	21.00	15.00	1.00	7.20
626120-0186-000	4.00	20.00	15.00	2.00	10.00

## M2, Spherical cylinder styli, ruby Spherical cylinder, without shaft

Cylindrical styli for thin sheets and narrow workpiece edges. In addition surface measurement with the spherical tip. M2 threads are common for Renishaw touch sensors.

Connection Type: M2  
 Shaft Material: Tung. Carb.  
 Stylus Tip Geometry: Spherical Cylinder  
 Stylus Tip Material: Ruby  
 Ø Body (DG): 3

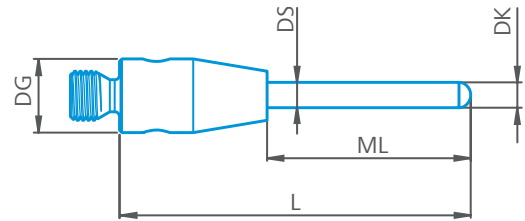

Article-No.	DK	L	ML	DS	B
626120-0112-000	1.50	15.00	8.00	1.50	8.00

## Disc styli

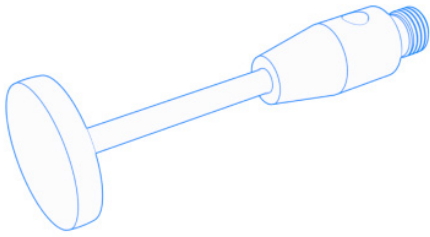

Disc styli are used, among other things, to measure rotationally symmetrical workpieces with undercuts or recesses and bores. However, a strong filtering of the surface roughness usually occurs. With the design of the spherical disk stylus, a higher accuracy is achieved compared to disk styli.

### M2, Disk styli, ceramic disk, tungsten carbide shaft

Disc styli to measure cylindrical workpieces with undercuts, grooves or recesses. M2 threads are common for Renishaw touch sensors.

Connection Type: M2  
 Shaft Material: Tung. Carb.  
 Stylus Tip Geometry: Disk  
 Stylus Tip Material: Ceramic  
 Ø Body (DG): 3

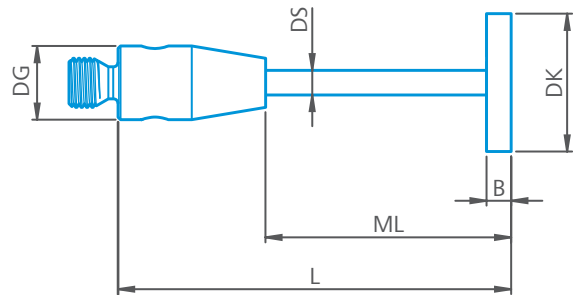

Article-No.	DK	L	ML	DS	B
602030-8202-000	4.00	32.00	19.00	1.00	1.00
602030-8201-000	8.00	32.00	19.00	1.50	1.50

### M2, Disc styli, tungsten carbide disc, tungsten carbide shaft

Disc styli to measure cylindrical workpieces with undercuts, grooves or recesses. M2 threads are common for Renishaw touch sensors.

Connection Type: M2  
 Shaft Material: Tung. Carb.  
 Stylus Tip Geometry: Disk  
 Stylus Tip Material: Tung. Carb.  
 Ø Body (DG): 3

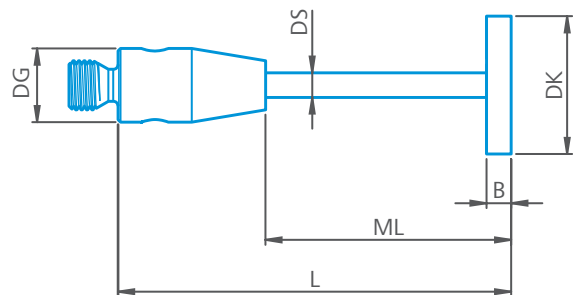

Article-No.	DK	L	ML	DS	B
626112-0440-020	4.40	20.00	16.00	1.00	0.50
626112-0500-021	5.00	20.50	15.50	2.00	0.50
626112-0501-021	5.00	21.00	16.00	1.00	1.00
626112-0550-020	5.50	20.00	16.00	1.50	0.50
626112-5001-011	10.00	10.60	4.60	2.00	1.20



## Without Thread

Styli without thread can be combined with clamping inserts to form various stylus configurations.

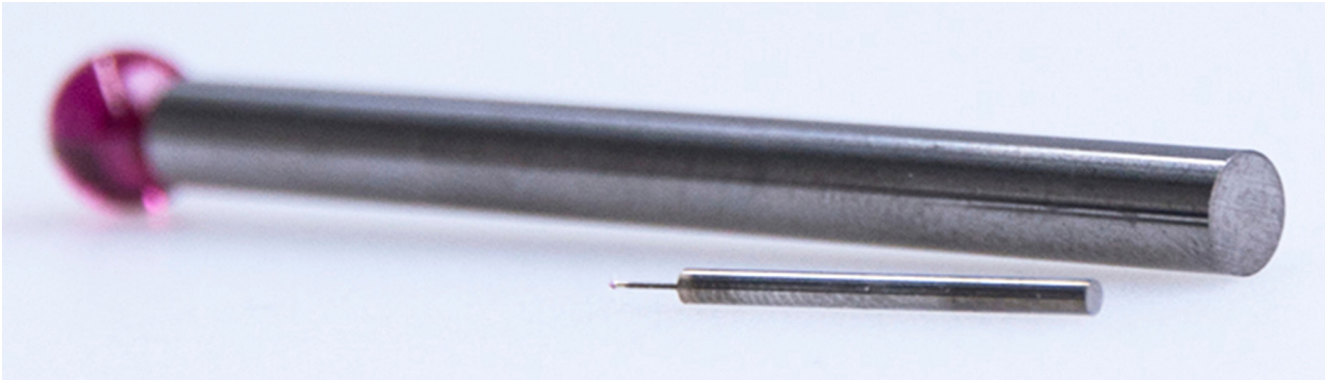

ZEISS threaded styli are used to measure even the smallest characteristics of parts. They are fastened in corresponding stylus holders. The stylus tip is made of either ruby or silicon nitride of the stylus shaft and consists of hard metal as standard. Styli without thread can be combined with the suitable connecting elements to form different configurations, e.g. L, T and star styli.

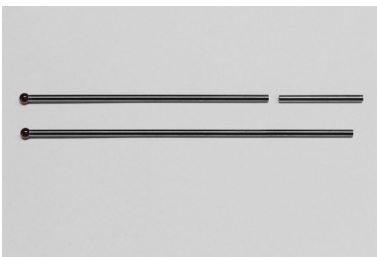

### Stylus of any length

Thanks to the special manufacturing process from ZEISS, non-threaded styli can be supplied in any length on request, within the technical specification. Shaft machining and sphere/shaft interface are manufactured using exclusive ZEISS processes and ensure the best service life.

### Star, T and L styli from standard elements

ZEISS relies on standard components for star, T and L styli. Special connecting elements and non-threaded styli in ZEISS quality can replace most custom-made components. The advantage is that, in case of a stylus break, it is usually only the stylus element (i.e. the stylus without thread) that has to be replaced and not the entire stylus. The chapter Connecting elements contains many unique and partially patented solutions for almost every application.

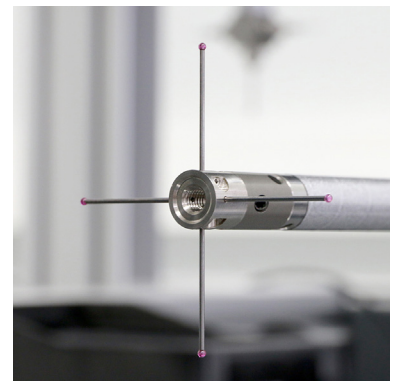

## Standard styli

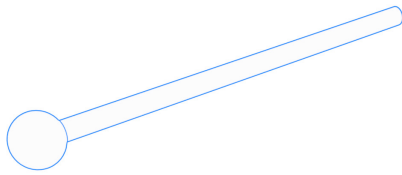

Spherical styli have the largest field of application because they have the same probing behavior in every direction. They are therefore suitable for all common measuring tasks such as measuring bores and surfaces. The larger the stylus sphere size, the larger the mechanical filter. This means that the profile of your workpiece is smoothed, which is often required in form measurement. The deviation from the ideal sphere shape is usually shown in Grade. ZEISS stylus tips come standard with Grade 5, but can also be offered with highly accurate roundness or diameters with a certificate for special requirements. Styli with a straight shaft are the most simple designed styli. The full shaft length can be used as measuring length. Stepped shaft has the advantage of a greater shaft thickness, which is reduced towards the measuring tip. This stepped shaft increases the stability of the shaft while maintaining the same length (depending on the sphere diameter). At the same time, however, the usable measuring length is reduced.

### Styli without thread straight, ruby sphere, tungsten carbide shaft

Styli without thread for use with special mounting adapters.

Connection Type: Without thread  
 Shaft Material: Tung. Carb.  
 Stylus Tip Geometry: Sphere  
 Stylus Tip Material: Ruby

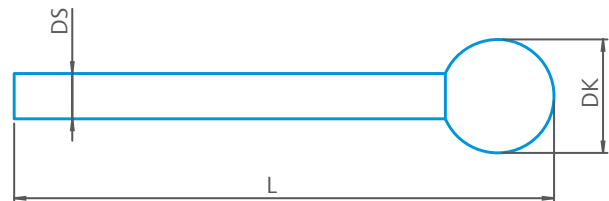

Article-No.	DK	L	DS
626111-0091-008	0.90	8.00	0.60
626111-0100-006	1.00	5.70	0.80
626111-0120-025	1.20	24.80	1.00
626111-0122-008	1.25	8.80	1.00
626111-0120-020	1.25	20.00	1.00
626111-0140-010	1.35	10.00	1.00
626111-0140-014	1.35	14.00	1.00
626111-0135-016	1.35	16.00	1.00
626111-0140-019	1.35	19.00	1.00
600341-8500-000	1.35	26.35	1.00
626111-0143-011	1.40	10.75	1.00
626111-0150-007	1.50	7.25	1.00
626111-0150-011	1.50	10.75	1.00
626111-0151-011	1.50	11.00	1.00
626111-0153-012	1.50	12.00	1.00
626111-0151-013	1.50	12.50	1.00
626111-0152-013	1.50	13.25	1.00
626111-0151-014	1.50	13.50	1.00
626111-0150-014	1.50	13.95	1.00
626111-0150-015	1.50	15.00	1.00
626111-0153-016	1.50	15.50	1.00
626111-0150-016	1.50	16.00	1.00





Article-No.	DK	L	DS
626111-0152-017	1.50	16.70	1.00
626111-0151-017	1.50	17.00	1.00
626111-0150-019	1.50	19.00	1.00
626111-0150-020	1.50	20.00	1.00
626111-0150-022	1.50	22.00	1.00
626111-0150-025	1.50	25.00	1.00
600341-8501-000	1.50	26.50	1.00
626111-0150-028	1.50	27.80	1.00
626111-0151-030	1.50	30.00	1.00
626111-0150-032	1.50	32.00	1.00
626111-0150-035	1.50	35.00	1.00
000000-1099-877	1.50	40.50	1.50
626111-0160-027	1.60	27.00	1.00
626111-0180-011	1.75	11.00	1.50
626111-0170-020	1.75	20.00	1.00
626111-0200-004	2.00	3.75	1.50
626111-0200-005	2.00	5.30	1.50
626111-0200-006	2.00	5.75	1.00
626111-0200-007	2.00	7.25	1.00
626111-0200-008	2.00	8.00	1.50
626111-0200-009	2.00	9.00	1.50
626111-0201-010	2.00	10.00	1.00
626111-0200-011	2.00	10.75	1.00
626111-0201-011	2.00	11.00	1.50
626111-0201-013	2.00	12.75	1.50
626111-0207-014	2.00	13.50	1.50
626111-0208-014	2.00	13.90	1.50
626111-0205-014	2.00	14.20	1.50
626111-0201-014	2.00	14.25	1.50
626111-0203-014	2.00	14.50	1.50
626111-0200-015	2.00	15.00	1.50
626111-0202-012	2.00	15.00	1.50
626111-0202-016	2.00	15.75	1.00
000000-1038-051	2.00	16.00	1.50
626111-0200-018	2.00	17.80	1.00
626111-0200-019	2.00	19.25	1.50
000000-1099-911	2.00	19.89	1.00
626111-0200-020	2.00	20.00	1.50
626111-0200-026	2.00	26.20	1.50
600341-8502-000	2.00	27.00	1.50
626111-0200-027	2.00	27.00	1.00
612030-9128-000	2.00	29.50	1.50
626111-0200-030	2.00	30.00	1.50
000000-1230-699	2.00	35.40	1.50
626111-0200-050	2.00	50.00	1.50
626111-0201-050	2.00	50.00	1.00
626111-0201-070	2.00	70.00	2.00
626111-0202-027	2.03	27.00	1.50
626111-0250-010	2.50	10.00	1.50
626111-0253-011	2.50	11.00	1.50
626111-0250-012	2.50	12.00	1.50
626111-0205-013	2.50	13.00	1.50
626111-0250-014	2.50	13.90	1.50
626111-0251-014	2.50	14.20	1.50



Article-No.	DK	L	DS
626111-0251-015	2.50	14.50	1.50
626111-0251-016	2.50	16.00	1.50
626111-0250-017	2.50	17.00	1.50
626111-0250-020	2.50	20.00	1.50
626111-0250-025	2.50	25.00	1.50
600341-8503-000	2.50	27.50	1.50
626111-0250-088	2.50	87.80	1.50
626111-0300-010	3.00	10.00	1.50
626111-0300-011	3.00	11.00	1.50
626111-0300-012	3.00	12.00	2.00
626111-0300-013	3.00	13.00	2.00
626111-0300-014	3.00	13.50	1.50
626111-0301-014	3.00	14.25	1.50
626111-0300-015	3.00	14.70	2.00
626111-0301-015	3.00	15.00	1.50
626111-0300-017	3.00	16.75	2.00
626111-0301-018	3.00	17.50	2.00
626111-0300-019	3.00	19.50	2.00
626111-0300-021	3.00	20.70	2.00
626111-0300-025	3.00	25.00	1.50
626111-0301-026	3.00	26.00	1.50
626111-0301-030	3.00	29.80	2.00
626111-0303-030	3.00	30.00	1.50
626111-0300-035	3.00	35.00	2.00
626111-0301-035	3.00	35.00	1.50
626111-0300-037	3.00	37.00	2.00
600341-8510-000	3.00	38.00	2.00
626111-0300-038	3.00	38.00	1.50
626111-0303-038	3.00	38.00	2.00
626111-0302-038	3.00	38.20	2.00
626111-0300-040	3.00	40.00	3.00
626111-0300-051	3.00	51.00	2.00
626111-0302-053	3.00	52.25	1.00
626111-0300-058	3.00	58.00	2.00
000000-1293-662	3.00	70.00	2.00
626111-0350-016	3.50	15.95	2.00
626101-0350-028	3.50	27.50	2.00
626111-0400-008	4.00	7.00	2.00
626111-0400-015	4.00	15.00	1.50
626111-0400-019	4.00	19.00	2.50
626111-0400-024	4.00	24.30	1.50
626111-0401-025	4.00	25.00	1.50
626111-0401-030	4.00	30.00	1.00
626111-0400-038	4.00	38.00	2.00
626111-0400-044	4.00	44.00	2.00
626111-0401-046	4.00	46.00	2.00
626111-0450-020	4.50	20.00	2.00
626111-0501-015	5.00	14.75	1.00
626111-0500-015	5.00	15.00	3.00
626111-0500-016	5.00	15.70	2.00
626111-0500-017	5.00	17.00	3.50



Article-No.	DK	L	DS
626111-0500-020	5.00	20.00	2.00
626111-0500-024	5.00	24.00	3.50
626111-0500-025	5.00	25.00	3.50
626111-0500-030	5.00	30.00	2.00
626111-0500-035	5.00	35.00	2.00
626111-0500-042	5.00	42.00	2.00
600341-8511-000	5.00	45.00	3.50
626111-0501-046	5.00	45.75	3.50
626111-0501-100	5.00	100.00	3.50
626111-0600-045	6.00	45.00	3.50
626111-0600-160	6.00	160.00	4.00
626111-0750-015	7.50	15.00	4.00
626111-0751-015	7.50	15.00	2.00

### Styli without thread straight, silicon nitride sphere, tungsten carbide shaft

Styli without thread for use with special mounting adapters.

Connection Type: Without thread  
 Shaft Material: Tung. Carb.  
 Stylus Tip Geometry: Sphere  
 Stylus Tip Material: Si. Nitride

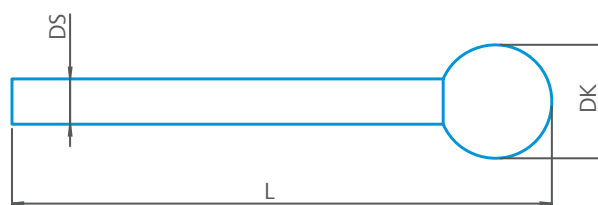

Article-No.	DK	L	DS
626111-0140-032	1.35	32.00	1.00
626111-0150-027	1.50	26.50	1.00
626111-0150-030	1.50	30.00	1.00
626111-0152-050	1.50	50.00	1.00
626111-0201-016	2.00	16.00	1.50
626111-0201-017	2.00	17.30	1.50
626111-0201-021	2.00	21.00	1.00
626111-0202-025	2.00	25.00	1.50
626111-0203-027	2.00	27.00	1.50
626111-0201-033	2.00	32.80	1.00
626111-0202-050	2.00	50.00	1.00
626111-0201-058	2.00	57.80	1.50
626111-0205-060	2.00	60.00	1.00
626111-0301-011	3.00	11.00	1.50
626111-0303-020	3.00	20.00	1.50
626111-0301-024	3.00	24.00	1.50
626111-0301-038	3.00	38.00	2.00
626111-0301-057	3.00	57.30	1.50
626111-0500-100	5.00	100.00	3.50
626111-0800-028	8.00	28.00	4.00

## Styli without thread stepped, silicon nitride sphere, tungsten carbide shaft

Styli without thread for use with special mounting adapters.

Connection Type: Without thread

Shaft Material: Tung. Carb.

Stylus Tip Geometry: Sphere

Stylus Tip Material: Si. Nitride

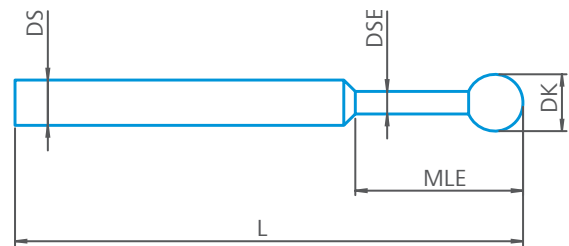

Article-No.	DK	L	DS	MLE	DSE
626111-0081-008	0.80	8.00	1.00	4.80	0.60
626111-0082-012	0.80	12.00	1.00	4.80	0.60
626111-0083-013	0.80	13.30	1.00	4.80	0.60
626111-0082-016	0.80	15.80	1.00	4.80	0.60
626111-0105-014	1.00	14.00	1.00	5.00	0.80
626111-0100-016	1.00	16.00	1.00	5.00	0.80
626111-0103-017	1.00	16.50	1.00	5.00	0.80

# Pivot styli



Swivel measuring probes can be used to measure inclined bores or surfaces. The angle of the stylus can be varied by up to 110°. A special holder is required to hold the stylus.

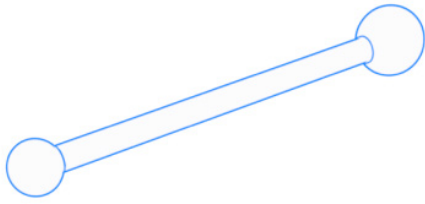

## Pivot styli, ruby sphere, tungsten carbide shaft

Connection Type: Without thread  
 Shaft Material: Tung. Carb.  
 Stylus Tip Geometry: Sphere  
 Stylus Tip Material: Ruby

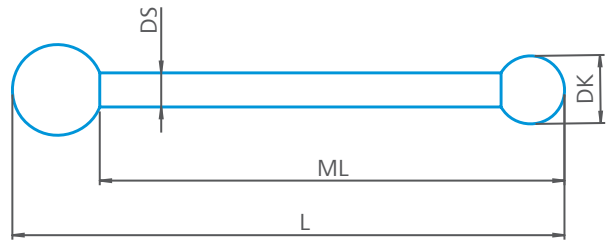

Article-No.	DK	L	ML	DS
600341-8185-000	2.00	28.50	24.50	1.50

## CMM Extensions

Extensions are used in metrology in the cases of complex stylus systems to bring styli closer to the workpiece

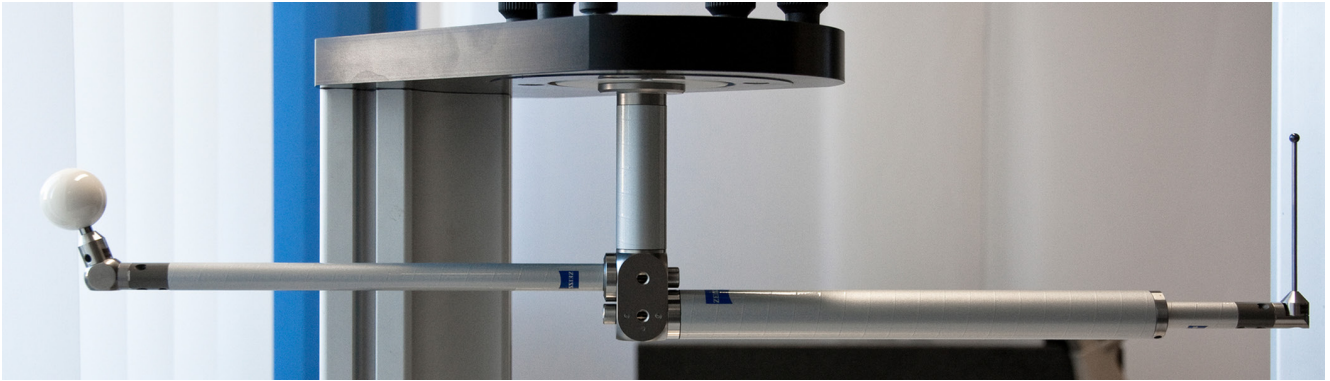

During the tactile measurement of a workpiece, many features may be difficult to access. For these cases a stylus extension can be used. While metal extensions are acceptable for touch trigger sensors, carbon fiber is a better choice for tactile scanning sensors.



### The perfect extension for your accuracy requirements

Measured values from coordinate measuring machines depend greatly on how well the stylus system reacts and reads the surface properties. The sensors contact to the workpiece is provided through the styli, extensions and the adapter plate. Therefore, as part of the overall probe system, extensions have a significant influence on measuring uncertainty.

For touch trigger sensors - such as the M2 and M3 systems - the extensions are still typically made of metal, as these materials have little effect on the measurement uncertainty compared to scanning technology.

For tactile scanning sensors, ZEISS REACH CFX® carbon fiber extensions offer benefits in every aspect, whether they are entry level or designed for maximum precision. Titanium and aluminum are older technologies and not recommended for CMMs. ZEISS REACH CFX® carbon fiber extensions are not only light and thermally stable in length, but also resistant to bending and torsion errors. This reduces deviations by up to five times and prevents expensive measurement errors due to inaccurate measuring results.

### REACH CFX® for your accuracy requirements

Three versions of the ZEISS REACH extensions are available for budget and accuracy requirements. The price of CFX® 1 is comparable with titanium or aluminum extensions, but performs significantly better than these metals in terms of precision. CFX® 3 has a significantly higher accuracy compared to the CFX 1 extensions. ZEISS REACH CFX® 5 offers the highest precision and technical attributes. This quality is unsurpassed on the market.

We recommend:

ZEISS REACH CFX® 1 for: ZEISS SPECTRUM, ZEISS CONTURA and comparable CMMs.

ZEISS REACH CFX® 3 for: ZEISS PRISMO, ZEISS PRISMO fortis, ZEISS ACCURA and similar CMMs.

ZEISS REACH CFX® 5 for: ZEISS PRISMO verity, ZEISS PRISMO ultra, ZEISS MICURA, ZEISS XENOS.



## M5 CFX® plate extensions

Extensions adapted directly to the adapter plate provide higher performance and better accuracy

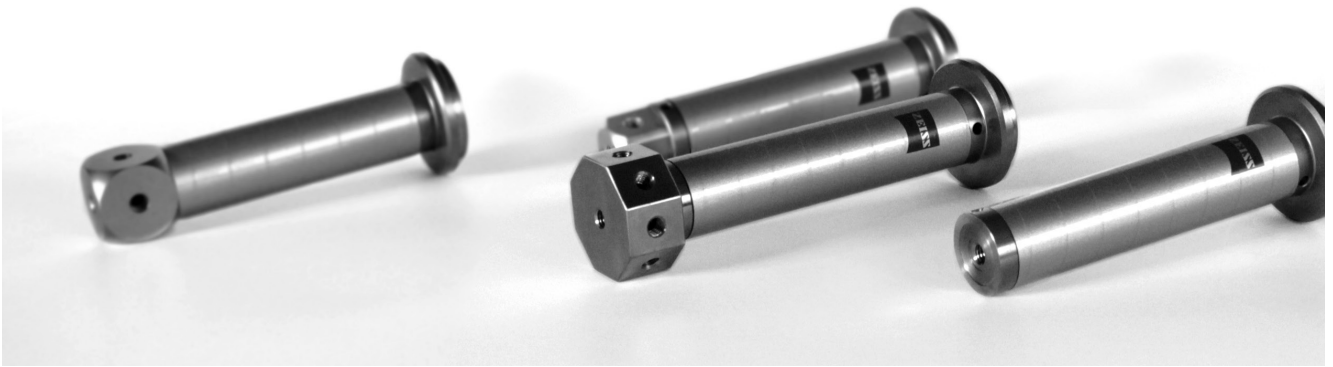

For many applications, replacing the cube on the common adaptor plate with an extension plate adaptor will reduce weight and achieve optimal stiffness and accuracy in a stylus system. If there are no features in the X or Y direction, or a Z direction extension is needed, the top cube should be removed. Designers should also use as few connections as possible and the threaded connections of the cube are not ideal and should be avoided. It is also particularly important to achieve the best possible stiffness in the region near the plate where the forces levers of the stylus system are greatest. ZEISS REACH CFX® plate extensions replace the standard interface between the plate cube and extension. This eliminates a connection point, reduces weight and ensures better performance of the system.



### Plate extensions to optimize existing stylus systems

When constructing particularly stiff and lightweight stylus systems, it is best to use plate extensions in proven ZEISS REACH CFX® technology. This reduces the number of connection points, saves up to 25% weight and the stiffness is almost doubled. An optimally stiff connection point directly on the adapter plate is indispensable for a reproducible measurement. With the ZEISS REACH CFX® plate extensions, this connection was precisely optimized with regard to high rigidity. The titanium adapter of the plate extension is made of one piece and allows an optimal force flow.

### Conventional stylus systems can be easily integrated into systems with plate extensions

The lengths of the plate extensions are designed in such a way that normal superstructures can be replaced 1:1 with plate-cube-extension-cube. This means that there is no additional work for adapting measuring programs if existing stylus systems are to be optimized with plate extensions.



## ZEISS REACH CFX® 3

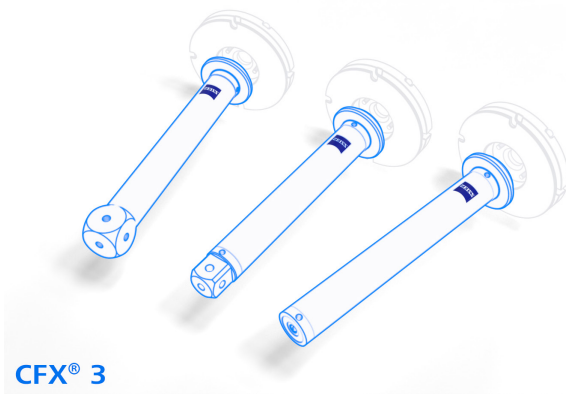

ZEISS REACH CFX® 3 extensions with M5 thread are made of a high-tech carbon fiber that has been specially developed for use in coordinate measuring machines. A special winding of the carbon fibers results in extensions with outstanding rigidity. The extensions are developed and optimized precisely to meet the requirements of high-precision measurement. Both bending and torsion are kept to a minimum. This enables highly accurate and reproducible measurements at high scanning speeds. The unrivaled quality of the ZEISS REACH CFX® 3 extensions makes them an all-rounder among extensions, as they can be used for almost all applications. The adapter plate (600667-9612-000) is not included in the scope of delivery.

### Plate extension without cube, ZEISS REACH CFX® 3, M5

Plate extensions are fastened directly to the adaptor plate at the point where the greatest force is applied. The use of plate extensions makes sense wherever it is not necessary to use a cube directly on the adaptor plate. This saves weight and removes a connection, thus increases the rigidity of the overall system.

Consisting of:

Titanium adapter for connection to adaptor plate

Ø20 mm CFX® 3 carbon fiber tube

Titanium adapter with M5 hole for connecting additional components in the Z-direction.

Connection Type: M5

Ø Body (DG): 20

Measuring Sensor: VAST/MT

Material: Carbon Fiber

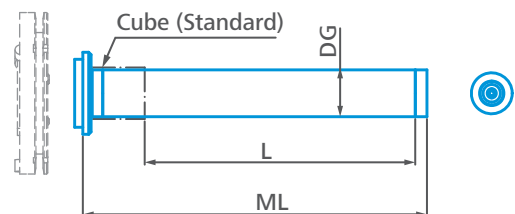

Article-No.	L	ML	System out
626107-2019-140	19.00	50.00	M5
626107-2044-140	44.00	75.00	M5
626107-2047-140	47.00	73.00	M5
626107-2069-140	69.00	100.00	M5
626107-2079-140	79.00	110.00	M5
626107-2107-140	107.00	133.00	M5
626107-2119-140	119.00	145.00	M5
626107-2121-140	121.00	147.00	M5
626107-2128-140	128.00	154.00	M5



## Plate extension with cube 15, ZEISS REACH CFX® 3, M5

Plate extensions are fastened directly to the adaptor plate at the point where the greatest force is applied. The use of plate extensions makes sense wherever it is not necessary to use a cube directly on the adaptor plate. This saves weight and removes a connection, thus increases the rigidity of the overall system. The integrated 15 mm cube enables the connection of additional elements in all main directions.

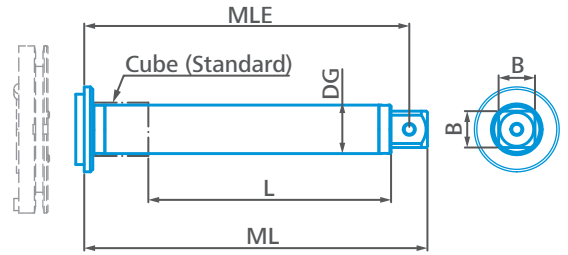

Consisting of:

Titanium adapter for connection to adaptor plate

Ø20 mm CFX® 3 carbon fiber tube

15 mm Titanium cube with M5 hole for connecting additional components in all main directions.

Connection Type: M5

Ø Body (DG): 20

Measuring Sensor: VAST/MT

Material: Carbon Fiber

Article-No.	L	ML	MLE	B	System out
626107-2025-130	25.00	66.50	59.00	15.00	M5
626107-2040-130	40.00	81.50	74.00	15.00	M5
626107-2050-130	50.00	91.50	84.00	15.00	M5
626107-2060-130	60.00	101.50	94.00	15.00	M5
626107-2080-130	80.00	121.50	114.00	15.00	M5
626107-2100-130	100.00	141.50	134.00	15.00	M5
626107-2120-130	120.00	161.50	154.00	15.00	M5
626107-2150-130	150.00	191.50	184.00	15.00	M5
626107-2200-130	200.00	241.50	234.00	15.00	M5

### Plate extension with cube 20, ZEISS REACH CFX® 3, M5

Plate extensions are fastened directly to the adaptor plate at the point where the greatest force is applied. The use of plate extensions makes sense wherever it is not necessary to use a cube directly on the adaptor plate. This saves weight and removes a connection, thus increases the rigidity of the overall system. The integrated 20 mm cube enables the connection of additional elements in all main directions.

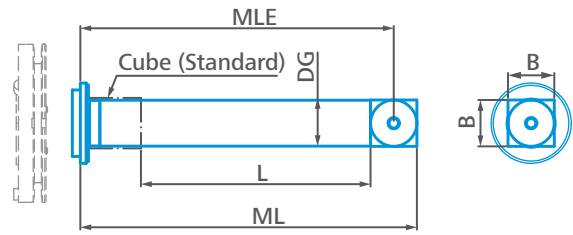

Consisting of:

Titanium adapter for connection to adaptor plate

Ø20 mm CFX® 3 carbon fiber tube

20 mm Titanium cube with M5 threads for connecting additional components in all main directions.

Connection Type: M5

Ø Body (DG): 20

Measuring Sensor: VAST/MT

Material: Carbon Fiber

Article-No.	L	ML	MLE	B	System out
626107-2025-110	25.00	71.50	61.40	20.00	M5
626107-2060-110	60.00	106.50	96.40	20.00	M5
626107-2080-110	80.00	126.50	116.40	20.00	M5
626107-2100-110	100.00	146.50	136.40	20.00	M5
626107-2120-110	120.00	166.50	156.40	20.00	M5
626107-2150-110	150.00	196.50	186.40	20.00	M5
626107-2200-110	200.00	246.50	236.40	20.00	M5

## ZEISS REACH CFX® 3, M5 Pro



ZEISS REACH CFX® 3 extensions with M5 pro connection technology are made of a high-tech carbon fiber that has been specially developed for use in coordinate measuring machines. A special winding of the carbon fibers results in extensions with outstanding rigidity. The extensions are developed and optimized precisely to meet the requirements of high-precision measurement. Both bending and torsion are kept to a minimum. This enables highly accurate and reproducible measurements at high scanning speeds. Thanks to the connection with the patented ZEISS M5 pro connection technology, these extensions are particularly suitable for use in production measurements. The special torsion resistance of the M5 pro technology results in an extremely reliable probe system. The adapter plate (600667-9612-000) is not included in the scope of delivery.

### Plate extension with single cube, ZEISS REACH CFX® 3, M5 pro

Plate extensions are fastened directly to the adaptor plate at the point where the greatest force is applied. The use of plate extensions makes sense wherever it is not necessary to use a cube directly on the adaptor plate. This saves weight and removes a connection, thus increases the rigidity of the overall system. The integrated 20 mm cube enables the connection of additional elements in all main directions. The M5 pro connections increase reliability for production measurements due to torsion-proof mounting.

Consisting of:

Titanium adapter for connection to adaptor plate

Ø20 mm CFX® 3 carbon fiber tube

20 mm Titanium cube with M5 pro index holes for connecting additional components in all main directions.

Connection Type: M5 Pro

Ø Body (DG): 20

Measuring Sensor: VAST/MT

Material: Carbon Fiber

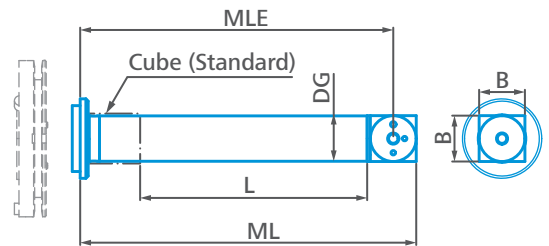

Article-No.	L	ML	MLE	B	System out
626107-2025-164	25.00	73.10	63.00	20.00	M5 Pro
626107-2040-164	40.00	88.10	78.00	20.00	M5 Pro
626107-2050-164	50.00	98.10	88.00	20.00	M5 Pro
626107-2060-164	60.00	108.10	98.00	20.00	M5 Pro
626107-2080-164	80.00	128.00	117.90	20.00	M5 Pro
626107-2100-164	100.00	148.10	138.00	20.00	M5 Pro
626107-2120-164	120.00	168.10	158.00	20.00	M5 Pro
626107-2150-164	150.00	198.10	188.00	20.00	M5 Pro
626107-2200-164	200.00	248.00	238.00	20.00	M5 Pro

### Plate extension with double cube, ZEISS REACH CFX® 3, M5 Pro

Plate extensions are fastened directly to the adaptor plate at the point where the greatest force is applied. The use of plate extensions makes sense wherever it is not necessary to use a cube directly on the adaptor plate. This saves weight and removes a connection, thus increases the rigidity of the overall system. The integrated double 20 mm cube enables the connection of up to 9 additional elements in all main directions. The M5 pro connections increase reliability for production measurements due to torsion-proof mounting.

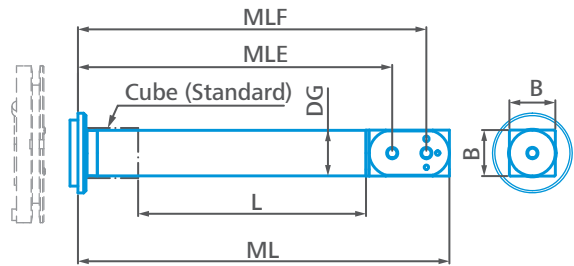

Consisting of:

Titanium adapter for connection to adaptor plate

Ø20 mm CFX® 3 carbon fiber tube

20 mm Titanium double cube with M5 pro index holes for connecting additional components in all main directions.

Connection Type: M5 Pro

Ø Body (DG): 20

Measuring Sensor: VAST/MT

Material: Carbon Fiber

Article-No.	L	ML	MLE	MLF	B	System out
626107-2025-160	25.00	88.10	63.00	78	20.00	M5 Pro
626107-2040-160	40.00	103.10	78.00	93	20.00	M5 Pro
626107-2050-160	50.00	113.10	88.00	103	20.00	M5 Pro
626107-2060-160	60.00	123.10	98.00	113	20.00	M5 Pro
626107-2080-160	80.00	143.10	118.00	133	20.00	M5 Pro
626107-2100-160	100.00	163.10	138.00	153	20.00	M5 Pro
626107-2120-160	120.00	183.10	158.00	173	20.00	M5 Pro
626107-2150-160	150.00	213.10	188.00	203	20.00	M5 Pro
626107-2200-160	200.00	263.10	238.00	253	20.00	M5 Pro

## Plate extension with double cube, offset connections, ZEISS REACH CFX® 3, M5 Pro

Plate extensions are fastened directly to the adaptor plate at the point where the greatest force is applied. The use of plate extensions makes sense wherever it is not necessary to use a cube directly on the adaptor plate. This saves weight and removes a connection, thus increases the rigidity of the overall system. The integrated double 20 mm cube enables the connection of up to 9 additional elements in all main directions. The M5 pro connections increase reliability for production measurements due to torsion-proof mounting.

Consisting of:

Titanium adapter for connection to adaptor plate

Ø20 mm CFX® 3 carbon fiber tube

20 mm Titanium double cube with offset M5 pro index holes for connecting additional components in all main directions.

Connection Type: M5 Pro

Ø Body (DG): 20

Measuring Sensor: VAST/MT

Material: Carbon Fiber

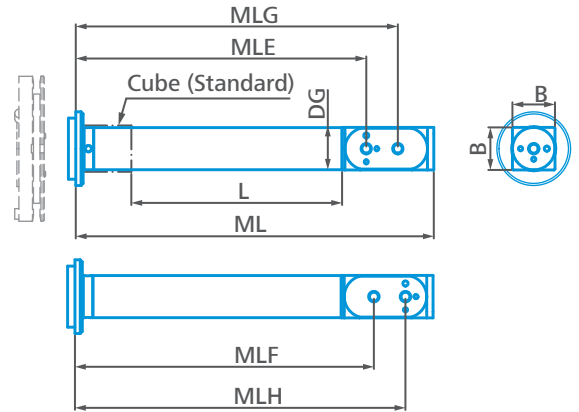

Article-No.	L	ML	MLE	MLF	MLG	MLH	B	System out
626107-2025-163	25.00	95.10	63.00	67	78	82	20.00	M5 Pro
626107-2040-163	40.00	110.10	78.00	82	93	97	20.00	M5 Pro
626107-2050-163	50.00	120.10	88.00	92	103	107	20.00	M5 Pro
626107-2060-163	60.00	130.10	98.00	102	113	117	20.00	M5 Pro
626107-2080-163	80.00	150.10	118.00	122	133	137	20.00	M5 Pro
626107-2100-163	100.00	170.10	138.00	142	153	157	20.00	M5 Pro
626107-2120-163	120.00	190.10	158.00	162	173	177	20.00	M5 Pro
626107-2150-163	150.00	220.10	188.00	192	203	207	20.00	M5 Pro
626107-2200-163	200.00	270.10	238.00	242	253	257	20.00	M5 Pro

### Plate extension with index hole, ZEISS REACH CFX® 3, M5 Pro

Plate extensions are fastened directly to the adaptor plate at the point where the greatest force is applied. The use of plate extensions makes sense wherever it is not necessary to use a cube directly on the adaptor plate. This saves weight and removes a connection, thus increases the rigidity of the overall system. The M5 thread and the two index holes enable the connection of additional standard and M5 pro elements in the Z direction. The M5 pro connections increase reliability for production measurements due to torsion-proof mounting.

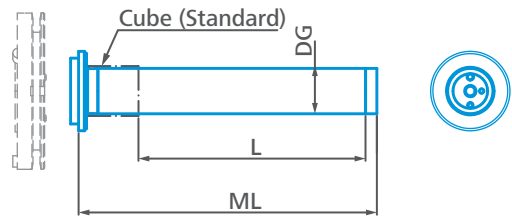

Consisting of:

Titanium adapter for connection to adaptor plate

Ø20 mm CFX® 3 carbon fiber tube

Titanium adapter with M5 pro index holes for connecting additional components in the Z-direction.

Connection Type: M5 Pro

Ø Body (DG): 20

Measuring Sensor: VAST/MT

Material: Carbon Fiber

Article-No.	L	ML	System out
626107-2025-141	25.00	56.50	M5 Pro
626107-2040-141	40.00	71.50	M5 Pro
626107-2050-141	50.00	81.50	M5 Pro
626107-2060-141	60.00	91.50	M5 Pro
626107-2080-141	80.00	111.50	M5 Pro
626107-2100-141	100.00	131.50	M5 Pro
626107-2120-141	120.00	151.50	M5 Pro
626107-2150-141	150.00	181.50	M5 Pro
626107-2200-141	200.00	231.50	M5 Pro

## Plate extension with index pin, ZEISS REACH CFX® 3, M5 Pro

Plate extensions are fastened directly to the adaptor plate at the point where the greatest force is applied. The use of plate extensions makes sense wherever it is not necessary to use a cube directly on the adaptor plate. This saves weight and removes a connection, thus increases the rigidity of the overall system. The M5 thread and the two index pins enable the connection of special M5 pro elements such as beams in all Z directions. The M5 pro connections increase reliability for production measurements due to torsion-proof mounting.

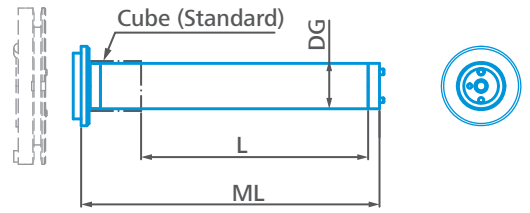

Consisting of:

Titanium adapter for connection to adaptor plate

Ø20 mm CFX® 3 carbon fiber tube

Titanium adapter with M5 pro pins for connecting special M5 pro components in the Z-direction.

Connection Type: M5 Pro

Ø Body (DG): 20

Measuring Sensor: VAST/MT

Material: Carbon Fiber

Article-No.	L	ML	System out
626107-2025-145	25.00	56.50	M5 Pro
626107-2040-145	40.00	71.50	M5 Pro
626107-2050-145	50.00	81.50	M5 Pro
626107-2060-145	60.00	91.50	M5 Pro
626107-2080-145	80.00	111.50	M5 Pro
626107-2100-145	100.00	131.50	M5 Pro
626107-2120-145	120.00	151.50	M5 Pro
626107-2150-145	150.00	181.50	M5 Pro
626107-2200-145	200.00	231.50	M5 Pro

## ZEISS REACH CFX® 5

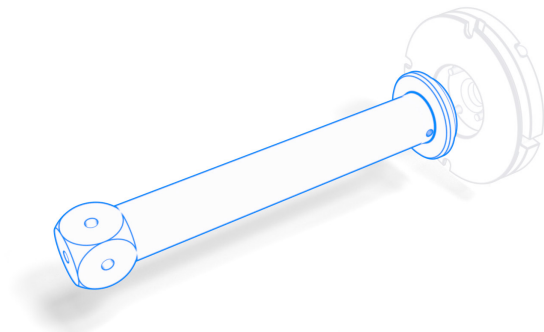

CFX® 5

A high-end carbon fiber with extremely high tensile strength is used in ZEISS REACH CFX® 5 extensions with M5 thread. This carbon fiber increases the rigidity of the extensions by up to 30% compared to CFX 3 extensions. Even better results can therefore be achieved with these machines on high-precision machines such as XENOS, Prismo ultra and MICURA. The ZEISS REACH CFX® 5 extensions are tools for absolute professionals who work with very tight tolerances. The adapter plate (600667-9612-000) is not included in the scope of delivery.

### Plate extension with cube 20, ZEISS REACH CFX® 5, M5

Plate extensions are fastened directly to the adaptor plate at the point where the greatest force is applied. The use of plate extensions makes sense wherever it is not necessary to use a cube directly on the adaptor plate. This saves weight and removes a connection, thus increases the rigidity of the overall system. The integrated 20 mm cube enables the connection of additional elements in all main directions.

Consisting of:

Titanium adapter for connection to adaptor plate

Ø20 mm CFX® 5 carbon fiber tube

20 mm Titanium cube with M5 holes for connecting additional components in all main directions.

Connection Type: M5

Ø Body (DG): 20

Measuring Sensor: VAST/MT

Material: Carbon Fiber

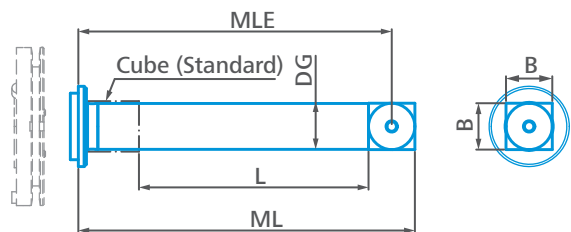

Article-No.	L	ML	MLE	B	System out
626107-2100-210	100.00	146.50	136.40	20.00	M5
626107-2150-210	150.00	196.50	186.40	20.00	M5
626107-2250-210	250.00	296.50	286.40	20.00	M5
626107-2350-210	350.00	396.50	386.40	20.00	M5



# ZEISS REACH CFX® 3, MMZ

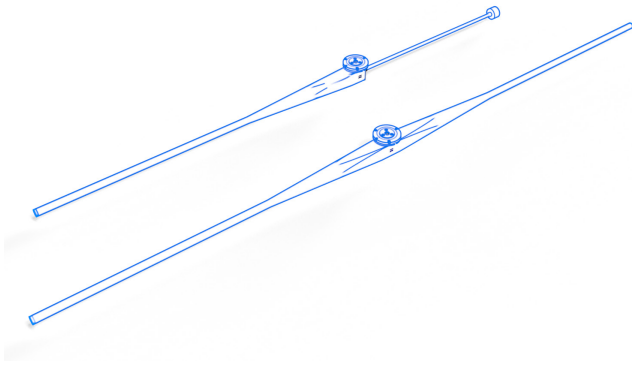

ZEISS REACH CFX® 3, MMZ meets the requirement of keeping carbon fiber extensions torsion and bending resistant even at great lengths. The special design means that the lightweight and length-stable material also benefits large machines. A special design directly on the interchangeable plate increases stability, especially for lengths that exceed the actual specification of the VAST measuring heads. The large devices in the ZEISS MMZ series are suitable for large-volume and heavy components that are fed in at ground level. They are used in many industries such as mechanical engineering, the automotive and aviation industries. The stylus extensions are available in five variants and are suitable for inspecting holes up to 1,200 mm deep. ZEISS REACH CFX® 3, MMZ extensions with interchangeable plate are only approved for use on ZEISS MMZ and large ACCURAs

## Plate extension, one-sided, ZEISS REACH CFX® 3, MMZ

The special design of the ZEISS REACH CFX® 3, MMZ extensions makes it possible to use extensions that exceed the specified length capacity of the measuring Sensor. These extensions are directly combined with the adaptor plate and are available in lengths up to 1,200 mm. Any tilting moments that occur can be compensated for by the integrated, adjustable counterweight. The large ZEISS MMZ series are suitable for large-volume and heavy components. They are used in many industries such as mechanical engineering, automotive and aviation industries. The probe extensions are available in different versions and are suitable, for inspecting deep holes on large components.

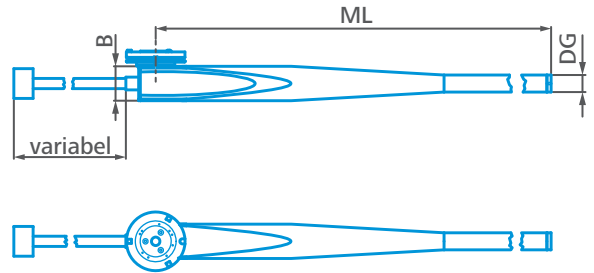

- Consisting of:
- VAST/VAST gold adaptor plate
- Directly adapted CFX® 3 carbon fiber tube
- Titanium adapter with M5 hole for connecting additional components in a lateral direction.
- Adjustable counterweight

Connection Type: ThermoFit XL  
 Ø Body (DG): 20  
 Measuring Sensor: VAST/MT  
 Material: Carbon Fiber

Article-No.	ML	B	System out
626107-5060-110	600.00	40.00	M5
626107-5120-130	1,200.00	40.00	M5
626107-5090-120	900.00	40.00	M5

### Plate extension, double-sided, ZEISS REACH CFX® 3, MMZ

The special design of the ZEISS REACH CFX® 3, MMZ extensions makes it possible to use extensions that exceed the specified length capacity of the measuring Sensor. These extensions are directly combined with the adaptor plate and provide a tandem extension with lengths up to 900 mm per side. The large ZEISS MMZ series are suitable for large-volume and heavy components. They are used in many industries such as mechanical engineering, automotive and aviation industries. The probe extensions are available in different versions and are suitable, for inspecting deep holes on large components.

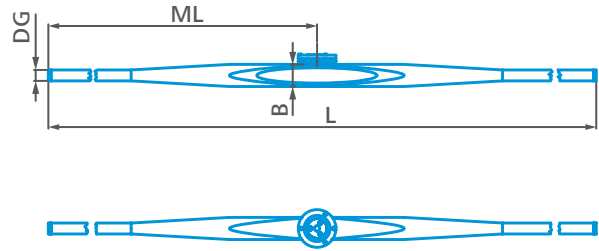

Consisting of:

VAST/VAST gold adaptor plate

Directly adapted CFX® 3 carbon fiber tube with tandem directions

Titanium adapter with M5 holes for connecting additional components in a lateral directions.

Connection Type: ThermoFit XL

Ø Body (DG): 20

Measuring Sensor: VAST/MT

Material: Carbon Fiber

Article-No.	L	ML	B	System out
626107-5060-000	1,200.00	600.00	40.00	M5
626107-5090-000	1,800.00	900.00	40.00	M5

## M5 CFX® extensions

ZEISS REACH CFX® M5 extensions are designed for ZEISS VAST/VAST Gold sensors



M5 extensions are tailored to VAST stylus systems. Available in lengths over 40 mm, their diversity unites material and unique manufacturing processing. Based on bending and torsion-resistant carbon fiber technology, ZEISS REACH CFX® ranks higher than the metal alternates even in the lower price segment. With three available versions, ZEISS REACH CFX® 1, CFX 3 and CFX 5, the extensions correspond to the accuracy level of the respective coordinate measuring machine.



### Complete portfolio for all applications

The extremely rigid and torsionally stiff carbon fiber extensions are manufactured exclusively by ZEISS. These extensions make it possible to replace metallic extensions used in both the production environment and the quality lab room. Metallic extensions are not sufficiently stable in length when exposed to temperature fluctuations to meet the requirements for measurement uncertainty.

#### 1. Allows fewer stylus systems changes

ZEISS REACH CFX® are very light weight and allow the assembly of more complex stylus systems without exceeding strict weight limits.

#### 2. Qualified for all measuring environments

ZEISS REACH CFX® is significantly more thermally stable than aluminum and up to 60 % more stiff than titanium. This delivers more accurate measurements when scanning the workpiece or in the manufacturing environment.

#### 3. Increased productivity

All extension in the portfolio are statically stiffer with less deflection compared to extensions made of titanium or aluminum. This allows faster scanning of the workpiece without losing accuracy.

#### 4. Reliable results

Three stiffness levels are available for REACH CFX® extensions – CFX® 1, CFX® 3 and CFX® 5 to ensure reliable measuring results. REACH CFX® extensions are designed to match different CMM classes so that accuracy is always aligned with the highest possible level.



## Suitable for all accuracy requirements

Extensions have the greatest influence on the accuracy and reproducibility of the measurement. Up to 60% of all measurement errors can be attributed to the use of unsuitable extensions. The use of unsuitable extensions ultimately reduces the overall accuracy of the CMM, which results in downgrading of the machine.

Not all carbon fibers are the same, so it is worth taking a closer look at the properties of carbon fiber extensions. ZEISS REACH CFX® is available in three different stiffness levels to suit different levels of accuracy. CFX® 1 is priced at the same level as titanium or aluminum extensions, but offers significantly better performance and precision than metal. CFX® 3 is priced in the middle segment and offers significantly higher accuracy than CFX® 1 extensions. CFX® 3 is to a certain extent the all-round option for extensions. CFX 5 rounds off the portfolio and meets the highest technical requirements. These high-end extensions are recommended for high-end machines such as XENOS, Prismo ultra or MICURA.

The quality of all REACH CFX® extensions is unsurpassed on the market, so with the right choice of these high-quality REACH extensions, higher accuracy can be achieved on machines in all segments. In other words, high quality ZEISS REACH CFX® carbon fiber extensions prevent degradation of machine accuracy.



# ZEISS REACH CFX® 1

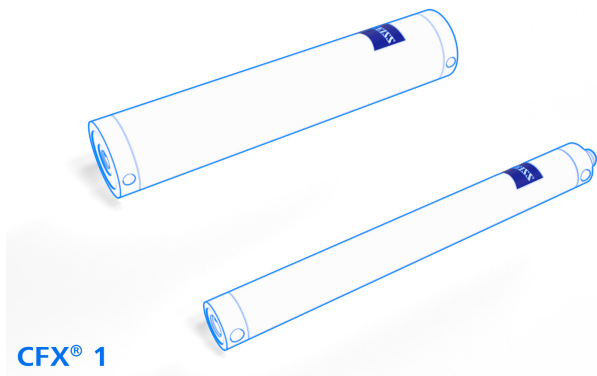

ZEISS REACH CFX® 1 extensions with M5 thread are the ideal entry to carbon fiber technology. However, compared to titanium extensions, a carbon fiber winding guarantees up to 40% better stiffness. ZEISS REACH CFX® 1 extensions enable significantly improved reproducibility, especially at faster scanning speeds. The quality of the CFX® 1 extensions are comparable to most carbon fiber extensions available on the market.

## M5 Extension Ø11, ZEISS REACH CFX® 1

Thermally stable standard extension for entry level applications. REACH CFX® 1 extensions are comparable to other carbon fiber extensions on the market in terms of design and rigidity. Compared to titanium or aluminum, CFX® 1 extensions achieve significantly better performance at comparable costs.

Consisting of:

Ø11 mm CFX® 1 carbon fiber tube

Titanium adapters with M5 screw and hole for connecting additional components

Connection Type: M5

Ø Body (DG): 11

Material: Carbon Fiber



Article-No.	L	System out
626107-1040-300	40.00	M5
626107-1050-300	50.00	M5
626107-1060-300	60.00	M5
626107-1075-300	75.00	M5
626107-1080-300	80.00	M5
626107-1090-300	90.00	M5
626107-1100-300	100.00	M5
626107-1120-300	120.00	M5
626107-1150-300	150.00	M5
626107-1200-300	200.00	M5
626107-1250-300	250.00	M5

## M5 Extension Ø20, ZEISS REACH CFX® 1

Thermally stable standard extension for entry level applications. REACH CFX® 1 extensions are comparable to other carbon fiber extensions on the market in terms of design and rigidity. Compared to titanium or aluminum, CFX® 1 extensions achieve significantly better performance at comparable costs.

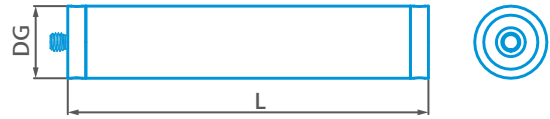

Consisting of:

Ø20 mm CFX® 1 carbon fiber tube

Titanium adapters with M5 screw and hole for connecting additional components

Connection Type: M5

Ø Body (DG): 20

Material: Carbon Fiber

Article-No.	L	System out
626107-2040-300	40.00	M5
626107-2050-300	50.00	M5
626107-2060-300	60.00	M5
626107-2075-300	75.00	M5
626107-2080-300	80.00	M5
626107-2090-300	90.00	M5
626107-2100-300	100.00	M5
626107-2120-300	120.00	M5
626107-2150-300	150.00	M5
626107-2200-300	200.00	M5
626107-2250-300	250.00	M5
626107-2300-300	300.00	M5
626107-2400-300	400.00	M5

# ZEISS REACH CFX® 3

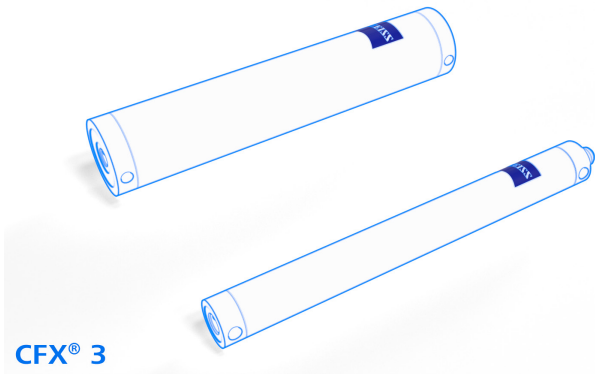

ZEISS REACH CFX® 3 extensions with M5 thread are made of a high-tech carbon fiber that has been specially developed for use in coordinate measuring machines. A special winding of the carbon fibers results in extensions with outstanding rigidity. The extensions are developed and optimized precisely to meet the requirements of high-precision measurement. Both bending and torsion are kept to a minimum. This enables highly accurate and reproducible measurements at high scanning speeds. The unrivaled quality of the ZEISS REACH CFX® 3 extensions makes them an all-rounder among extensions, as they can be used for almost all applications.

## M5 Extension Ø11, ZEISS REACH CFX® 3

Thermally stable standard extension, for most applications. REACH CFX® 3 extensions have a very high level of rigidity which enables reproducible measurements even at high scanning speeds.

Consisting of:  
 Ø11 mm CFX® 3 carbon fiber tube  
 Titanium adapters with M5 screw and hole for connecting additional components

Connection Type: M5  
 Ø Body (DG): 11  
 Material: Carbon Fiber



Article-No.	L	System out
626107-1035-100	35.00	M5
626107-1040-100	40.00	M5
626107-1045-100	45.00	M5
626107-1050-100	50.00	M5
626107-1055-100	55.00	M5
626107-1060-100	60.00	M5
626107-1065-100	65.00	M5
626107-1070-100	70.00	M5
626107-1075-100	75.00	M5
626107-1080-100	80.00	M5
626107-1085-100	85.00	M5
626107-1090-100	90.00	M5
626107-1095-100	95.00	M5
626107-1100-100	100.00	M5
626107-1105-100	105.00	M5
626107-1110-100	110.00	M5
626107-1115-100	115.00	M5
626107-1120-100	120.00	M5
626107-1125-100	125.00	M5
626107-1130-100	130.00	M5
626107-1135-100	135.00	M5



Article-No.	L	System out
626107-1140-100	140.00	M5
626107-1145-100	145.00	M5
626107-1150-100	150.00	M5
626107-1160-100	160.00	M5
626107-1165-100	165.00	M5
626107-1170-100	170.00	M5
626107-1175-100	175.00	M5
626107-1180-100	180.00	M5
626107-1185-100	185.00	M5
626107-1190-100	190.00	M5
626107-1200-100	200.00	M5
626107-1205-100	205.00	M5
626107-1210-100	210.00	M5
626107-1215-100	215.00	M5
626107-1220-100	220.00	M5
626107-1225-100	225.00	M5
626107-1230-100	230.00	M5
626107-1235-100	235.00	M5
626107-1240-100	240.00	M5
626107-1245-100	245.00	M5
626107-1250-100	250.00	M5
626107-1260-100	260.00	M5
626107-1270-100	270.00	M5
626107-1280-100	280.00	M5
626107-1290-100	290.00	M5
626107-1300-100	300.00	M5
626107-1310-100	310.00	M5
626107-1320-100	320.00	M5
626107-1330-100	330.00	M5
626107-1345-100	345.00	M5
626107-1350-100	350.00	M5
626107-1360-100	360.00	M5
626107-1370-100	370.00	M5
626107-1380-100	380.00	M5
626107-1390-100	390.00	M5
626107-1400-100	400.00	M5
626107-1410-100	410.00	M5
626107-1440-100	440.00	M5
626107-1450-100	450.00	M5
626107-1500-100	500.00	M5



## M5 Extension Ø20, ZEISS REACH CFX® 3

Thermally stable standard extension for entry level applications. REACH CFX® 1 extensions are comparable to other carbon fiber extensions on the market in terms of design and rigidity. Compared to titanium or aluminum, CFX® 1 extensions achieve significantly better performance at comparable costs.

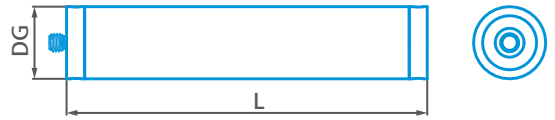

Consisting of:

Ø20 mm CFX® 3 carbon fiber tube

Titanium adapters with M5 screw and hole for connecting additional components

Connection Type: M5

Ø Body (DG): 20

Material: Carbon Fiber

Article-No.	L	System out
626107-2040-100	40.00	M5
626107-2050-100	50.00	M5
626107-2060-100	60.00	M5
626107-2070-100	70.00	M5
626107-2075-100	75.00	M5
626107-2080-100	80.00	M5
626107-2085-100	85.00	M5
626107-2090-100	90.00	M5
626107-2100-100	100.00	M5
626107-2110-100	110.00	M5
626107-2120-100	120.00	M5
626107-2130-100	130.00	M5
626107-2140-100	140.00	M5
626107-2150-100	150.00	M5
626107-2155-100	155.00	M5
626107-2160-100	160.00	M5
626107-2170-100	170.00	M5
626107-2175-100	175.00	M5
626107-2180-100	180.00	M5
626107-2190-100	190.00	M5
626107-2200-100	200.00	M5
626107-2210-100	210.00	M5
626107-2220-100	220.00	M5
626107-2240-100	240.00	M5
626107-2250-100	250.00	M5
626107-2280-100	280.00	M5
626107-2290-100	290.00	M5
626107-2300-100	300.00	M5
626107-2310-100	310.00	M5
626107-2347-100	347.00	M5
626107-2350-100	350.00	M5
626107-2360-100	360.00	M5
626107-2366-100	366.00	M5
626107-2400-100	400.00	M5
626107-2410-100	410.00	M5
626107-2440-100	440.00	M5



Article-No.	L	System out
626107-2450-100	450.00	M5
626107-2500-100	500.00	M5
626107-2550-100	550.00	M5
626107-2600-100	600.00	M5
626107-2620-100	620.00	M5
626107-2630-100	630.00	M5
626107-2640-100	640.00	M5
626107-2650-100	650.00	M5
626107-2655-100	655.00	M5
626107-2670-100	670.00	M5
626107-2700-100	700.00	M5
626107-2750-100	750.00	M5
626107-2800-100	800.00	M5

### M5 Extension Ø11 with holder for rotatable elements, ZEISS REACH CFX® 3

Thermally stable standard extension, for most applications. REACH CFX® 3 extensions have a very high level of rigidity which enables reproducible measurements even at high scanning speeds. With cone receiver for connecting rotatable components such as cubes or angle pieces.

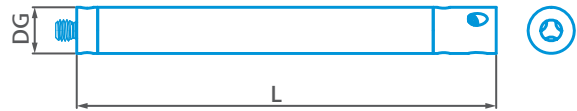

Consisting of:

Ø11 mm CFX® 3 carbon fiber tube

Titanium adapters with M5 screw and cone receiver for connecting rotatable components

Connection Type: M5

Ø Body (DG): 11

Material: Carbon Fiber

Article-No.	L	System out
626107-1050-105	50.00	Cone Receiver
626107-1060-105	60.00	Cone Receiver
626107-1070-105	70.00	Cone Receiver
626107-1080-105	80.00	Cone Receiver
626107-1090-105	90.00	Cone Receiver
626107-1100-105	100.00	Cone Receiver
626107-1110-105	110.00	Cone Receiver
626107-1130-105	130.00	Cone Receiver
626107-1160-105	160.00	Cone Receiver
626107-1190-105	190.00	Cone Receiver
626107-1210-105	210.00	Cone Receiver
626107-1260-105	260.00	Cone Receiver
626107-1310-105	310.00	Cone Receiver
626107-1410-105	410.00	Cone Receiver

# ZEISS REACH CFX® 5

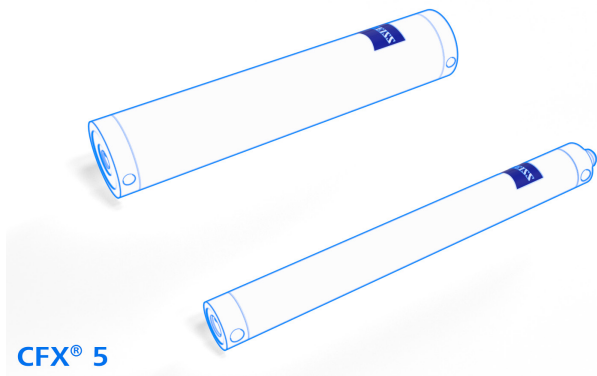

A high-end carbon fiber with extremely high tensile strength is used in ZEISS REACH CFX® 5 extensions with M5 thread. This carbon fiber increases the rigidity of the extensions by up to 30% compared to CFX 3 extensions. Even better results can therefore be achieved with these machines on high-precision machines such as XENOS, Prismo ultra and MICURA. The ZEISS REACH CFX® 5 extensions are tools for absolute professionals who work with very tight tolerances.

## M5 Extension Ø11, ZEISS REACH CFX® 5

Thermally stable standard extension, for high-precision applications. REACH CFX® 5 extensions are made of high-end carbon fibers and are used for measuring critical tolerances on high-end machines such as XENOS, Micura or Prismo Ultra

Consisting of:  
 Ø11 mm CFX® 5 carbon fiber tube  
 Titanium adapters with M5 screw and hole for connecting additional components

Connection Type: M5  
 Ø Body (DG): 11  
 Material: Carbon Fiber



Article-No.	L	System out
626107-1040-200	40.00	M5
626107-1050-200	50.00	M5
626107-1060-200	60.00	M5
626107-1075-200	75.00	M5
626107-1080-200	80.00	M5
626107-1090-200	90.00	M5
626107-1100-200	100.00	M5
626107-1120-200	120.00	M5
626107-1150-200	150.00	M5
626107-1200-200	200.00	M5
626107-1250-200	250.00	M5

## M5 Extension Ø20, ZEISS REACH CFX® 5

Thermally stable standard extension, for high-precision applications. REACH CFX® 5 extensions are made of high-end carbon fibers and are used for measuring critical tolerances on high-end machines such as XENOS, Micura or Prismo Ultra

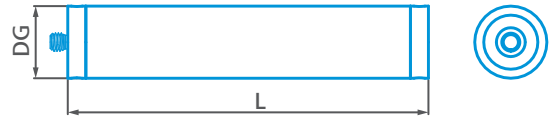

Consisting of:  
 Ø20 mm CFX® 5 carbon fiber tube  
 Titanium adapters with M5 screw and hole for connecting additional components

Connection Type: M5  
 Ø Body (DG): 20  
 Material: Carbon Fiber

Article-No.	L	System out
626107-2040-200	40.00	M5
626107-2050-200	50.00	M5
626107-2060-200	60.00	M5
626107-2075-200	75.00	M5
626107-2080-200	80.00	M5
626107-2090-200	90.00	M5
626107-2100-200	100.00	M5
626107-2120-200	120.00	M5
626107-2150-200	150.00	M5
626107-2200-200	200.00	M5
626107-2250-200	250.00	M5
626107-2300-200	300.00	M5
626107-2400-200	400.00	M5



## M5 pro CFX® extensions

ZEISS REACH CFX® M5 pro extensions for faster and reliable assembly



The ZEISS M5 pro system is the next-generation accessory for stylus system accessories. One solution for all stylus systems without the need to use special connection elements. Additional CAD design capacity is not required. Prefabricated blanks and angle pieces enable considerably shorter delivery times for angle elements. Together with CALYPSO Planner and the Stylus System Creator, this allows you to reduce the time required to start new measuring projects because measuring programs are created simultaneously with the production of the stylus system. Changes are made quickly and easily by the pluggable rotating elements. No additional documentation is required as it is immediately available within the Stylus System Creator. The plug-in elements ensure that the alignment of the stylus systems remains stable and reliable even in production operation.

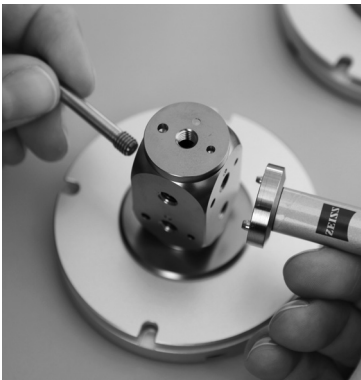

### Patented ZEISS M5 pro portfolio

The patented plug-in system makes it possible to create push-button systems quickly and easily from customer-specific standard components. The portfolio consists of pluggable standard components with diameters of 11 and 20 mm and bonded extensions, which are reduced from 20 mm to 11 mm and have no threaded interface. All M5 pro extensions have an integrated swivel mount for a variety of end pieces such as cubes and star elements. Further information can be found in the Connecting elements section.

### Suitable for all accuracy requirements

The M5 pro REACH CFX® extension portfolio is also available in different quality variants. The standard portfolio is REACH CFX® 3+ because of the the price-performance ratio and versatility to all common measuring tasks. REACH CFX® 5+ is the high-end portfolio for XENOS, Prismo ultra and MICURA machines for tasks with tight tolerances. Currently REACH CFX® 5+ is only available on request. M5 pro REACH CFX® 1+ is currently not offered.



## ZEISS REACH CFX® 3, M5 pro

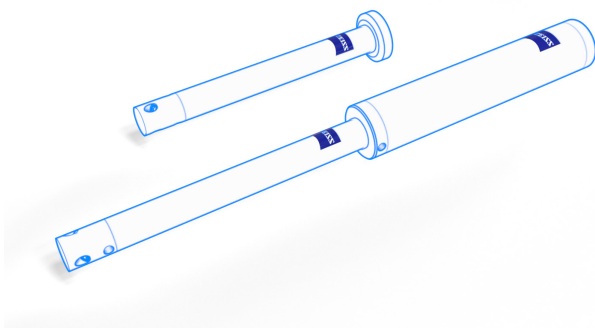

ZEISS REACH CFX® 3 extensions with M5 pro connection technology are made of a high-tech carbon fiber that has been specially developed for use in coordinate measuring machines. A special winding of the carbon fibers results in extensions with outstanding rigidity. The extensions are developed and optimized precisely to meet the requirements of high-precision measurement. Both bending and torsion are kept to a minimum. This enables highly accurate and reproducible measurements at high scanning speeds. Thanks to the connection with the patented ZEISS M5 pro connection technology, these extensions are particularly suitable for use in production measurements. The special torsion resistance of the M5 pro technology results in an extremely reliable probe system.

### M5 Extension Ø20, ZEISS REACH CFX® 5 M5 pro

REACH CFX® 3 M5 pro extensions are designed with a base of Ø20 mm and two index pins to prevent them from rotating. The angular alignment on the cube always remains constant, even after multiple removal and attachment. At the end of each extension, a cone receiver for connecting rotatable components.

Consisting of:

Ø20 mm CFX® 3 carbon fiber tube

Titanium adapters with M5 pro index pins and cone receiver for connecting rotatable components

Connection Type: M5 Pro

Ø Body (DG): 11

Material: Carbon Fiber



Article-No.	L	System out
626107-4040-000	40.00	Cone Receiver
626107-4045-000	45.00	Cone Receiver
626107-4050-000	50.00	Cone Receiver
626107-4060-000	60.00	Cone Receiver
626107-4065-000	65.00	Cone Receiver
626107-4070-000	70.00	Cone Receiver
626107-4075-000	75.00	Cone Receiver
626107-4080-000	80.00	Cone Receiver
626107-4085-000	85.00	Cone Receiver
626107-4090-000	90.00	Cone Receiver
626107-4100-000	100.00	Cone Receiver
626107-4105-000	105.00	Cone Receiver
626107-4110-000	110.00	Cone Receiver
626107-4115-000	115.00	Cone Receiver
626107-4120-000	120.00	Cone Receiver
626107-4130-000	130.00	Cone Receiver
626107-4135-000	135.00	Cone Receiver
626107-4150-000	150.00	Cone Receiver



Article-No.	L	System out
626107-4155-000	155.00	Cone Receiver
626107-4160-000	160.00	Cone Receiver
626107-4165-000	165.00	Cone Receiver
626107-4170-000	170.00	Cone Receiver
626107-4180-000	180.00	Cone Receiver
626107-4190-000	190.00	Cone Receiver
626107-4195-000	195.00	Cone Receiver
626107-4200-000	200.00	Cone Receiver
626107-4210-000	210.00	Cone Receiver
626107-4220-000	220.00	Cone Receiver
626107-4230-000	230.00	Cone Receiver
626107-4235-000	235.00	Cone Receiver
626107-4240-000	240.00	Cone Receiver
626107-4245-000	245.00	Cone Receiver
626107-4250-000	250.00	Cone Receiver
626107-4260-000	260.00	Cone Receiver
626107-4270-000	270.00	Cone Receiver
626107-4300-000	300.00	Cone Receiver
626107-4310-000	310.00	Cone Receiver
626107-4335-000	335.00	Cone Receiver
626107-4350-000	350.00	Cone Receiver
626107-4365-000	365.00	Cone Receiver
626107-4410-000	410.00	Cone Receiver

### M5 Extension, stepped, ZEISS REACH CFX® 3 M5 pro

REACH CFX® 3 M5 pro extensions are designed with a base of  $\varnothing 20$  mm and two index pins to prevent them from rotating. The angular alignment on the cube always remains constant, even after multiple removal and attachment. At the end of each extension, a cone receiver for connecting rotatable components.

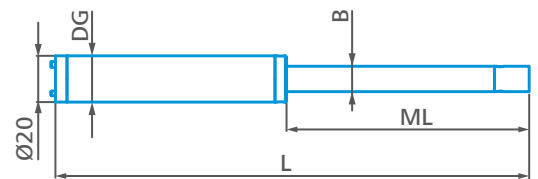

Consisting of:  
 $\varnothing 20$  mm CFX® 3 carbon fiber tube bonded to a  $\varnothing 11$  mm CFX® 3 carbon fiber tube  
 Titanium adapters with M5 pro index pins and cone receiver for connecting rotatable components

Connection Type: M5 Pro  
 $\varnothing$  Body (DG): 20  
 Material: Carbon Fiber

Article-No.	L	ML	B	System out
626107-4125-045	125.00	45.00	11.00	Cone Receiver
626107-4150-090	150.00	90.00	11.00	Cone Receiver
626107-4165-045	165.00	45.00	11.00	Cone Receiver
626107-4165-105	165.00	105.00	11.00	Cone Receiver
626107-4190-090	190.00	90.00	11.00	Cone Receiver
626107-4195-105	195.00	105.00	11.00	Cone Receiver
626107-4205-105	205.00	105.00	11.00	Cone Receiver
626107-4215-155	215.00	155.00	11.00	Cone Receiver
626107-4245-045	245.00	45.00	11.00	Cone Receiver



<b>Article-No.</b>	<b>L</b>	<b>ML</b>	<b>B</b>	<b>System out</b>
626107-4255-155	255.00	155.00	11.00	Cone Receiver
626107-4255-105	255.00	105.00	11.00	Cone Receiver
626107-4265-065	265.00	65.00	11.00	Cone Receiver
626107-4265-205	265.00	205.00	11.00	Cone Receiver
626107-4275-155	275.00	155.00	11.00	Cone Receiver
626107-4285-085	285.00	85.00	11.00	Cone Receiver
626107-4305-205	305.00	205.00	11.00	Cone Receiver
626107-4305-155	305.00	155.00	11.00	Cone Receiver
626107-4305-105	305.00	105.00	11.00	Cone Receiver
626107-4315-065	315.00	65.00	11.00	Cone Receiver
626107-4325-205	325.00	205.00	11.00	Cone Receiver
626107-4335-035	335.00	35.00	11.00	Cone Receiver
626107-4335-085	335.00	85.00	11.00	Cone Receiver
626107-4355-105	355.00	105.00	11.00	Cone Receiver
626107-4355-205	355.00	205.00	11.00	Cone Receiver
626107-4355-255	355.00	255.00	11.00	Cone Receiver
626107-4355-155	355.00	155.00	11.00	Cone Receiver
626107-4365-065	365.00	65.00	11.00	Cone Receiver
626107-4375-255	375.00	255.00	11.00	Cone Receiver
626107-4385-085	385.00	85.00	11.00	Cone Receiver
626107-4405-105	405.00	105.00	11.00	Cone Receiver
626107-4405-255	405.00	255.00	11.00	Cone Receiver
626107-4405-155	405.00	155.00	11.00	Cone Receiver
626107-4405-205	405.00	205.00	11.00	Cone Receiver
626107-4420-090	420.00	90.00	11.00	Cone Receiver
626107-4445-165	445.00	165.00	11.00	Cone Receiver
626107-4450-050	450.00	50.00	11.00	Cone Receiver
626107-4455-155	455.00	155.00	11.00	Cone Receiver
626107-4460-400	460.00	400.00	11.00	Cone Receiver
626107-4465-165	465.00	165.00	11.00	Cone Receiver
626107-4465-155	465.00	155.00	11.00	Cone Receiver
626107-4465-065	465.00	65.00	11.00	Cone Receiver
626107-4485-085	485.00	85.00	11.00	Cone Receiver



# M5 Titanium extension

Use as intermediate connections for lengths of 30 mm or less

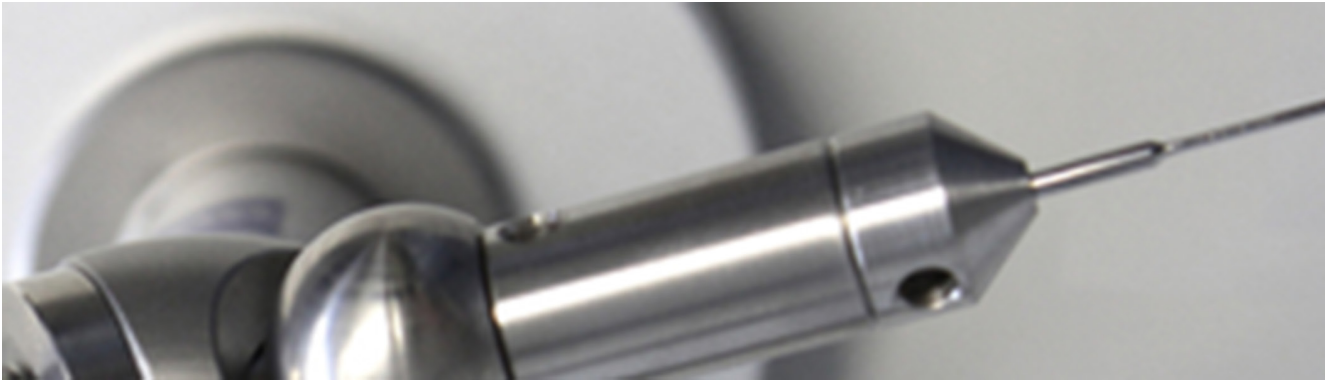

M5 titanium extensions are suitable when extension lengths of 30 mm or less are required. These shorter lengths cannot be offered in the high-quality carbon fiber technology because of material and manufacturing reasons. Titanium extensions longer than 40 mm are not recommended. Due to the smaller diameter and the very thin wall thickness design contributes the reduced stiffness and thermal instability. With respect to carbon fiber extensions this leads to increased measurement uncertainty and thus to unreliable measurement results.



## History of Titanium Extensions

Titanium extensions were developed over 30 years ago to provide an alternative to the common aluminum extensions. CMMs were moving from the measuring lab into the production environment, and thermal expansion of titanium performed slightly better. The significantly higher weight of titanium, compared to aluminum, required geometric design changes in order to achieve approximately the same weight as the aluminum tubes. However, the reduced diameter and the thin wall thickness of the tubes resulted in a significant reduction in rigidity and poor accuracy performance. The development and evolution of carbon fiber tubes eventually led to the titanium extensions being replaced permanently.

## Measurement process optimization by exchanging the extensions

By swapping titanium extensions to the high-quality carbon fiber technology REACH CFX®, a significantly better performance of the machine is often achieved. REACH CFX® 1 extensions are up to 40% stiffer than titanium extensions of the same length. Particularly at higher scanning speeds, this leads to a significantly improved reproducibility and a lower measurement uncertainty of the measurement process. With REACH CFX® 3 or REACH CFX® 5 extensions, this effect can be further increased.

Material	Weight	Extension	Deflection
ZEISS REACH CFX 5			
ZEISS REACH CFX 3*			
ZEISS REACH CFX 1			
Aluminum			
Titanium			

\* ZEISS REACH CFX 3 is the new name for ZEISS ThemaFib®

## Titanium connectors

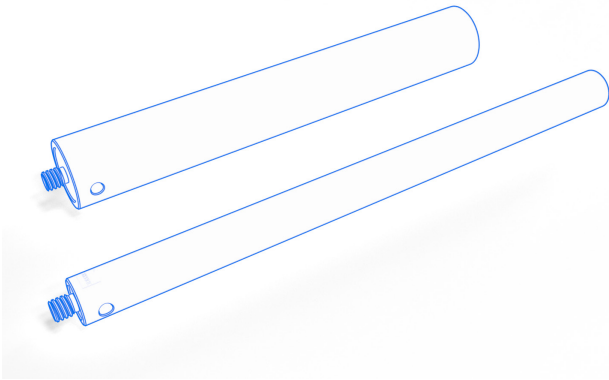

Due to the geometric properties of carbon fiber, extension lengths less than 40 mm cannot be fabricated with this technology. Therefore, if lengths of less than 40 mm are required, connecting pieces are still available in titanium. However, these connecting pieces are not tubes but consist of solid material and therefore have no negative influence on the measurement result. Due to the poor properties of titanium extensions, longer titanium extensions are no longer used in modern measurement technology.

### M5 Extension Ø11, titanium

Ø11 titanium connectors up to a length of 30 mm are used to bridge short distances. For lengths over 30 mm, only carbon fiber extensions are used.

Consisting of:

Ø11 mm solid Titanium

M5 screw and hole for connecting additional components

Connection Type: M5

Ø Body (DG): 11

Material: Titanium

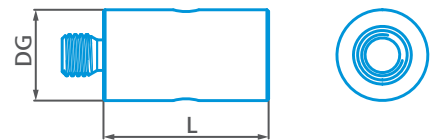

Article-No.	L	System out
602030-9044-000	10.00	M5
602030-9045-000	15.00	M5
602030-9046-000	20.00	M5
602030-9047-000	25.00	M5
000000-1251-674	30.00	M5



## M5 Extension Ø18, titanium

Ø18 titanium connectors up to a length of 30 mm are used to bridge short distances. For lengths over 25 mm, only carbon fiber extensions are used.

Consisting of:

Ø18 mm solid Titanium

M5 screw and hole for connecting additional components

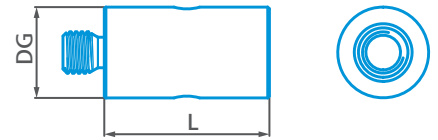

Connection Type: M5

Ø Body (DG): 18

Material: Titanium

Article-No.	L	System out
626117-2010-030	10.00	M5
626117-2015-030	15.00	M5
602030-9048-000	25.00	M5

## M3 XXT CFX® extensions

ZEISS REACH CFX® 1, M3 XXT extensions. Designed for the ZEISS VAST XXT measuring sensor

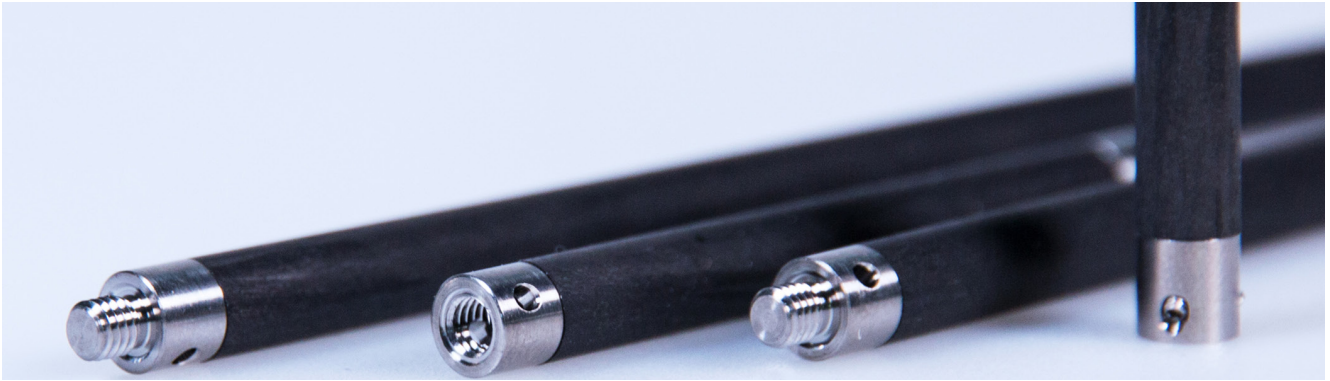

ZEISS REACH CFX® 1 M3 XXT extensions have been specifically developed for the ZEISS VAST XXT measuring sensor. These extensions consist of carbon fiber tubes exclusively wound for ZEISS. At five millimeters, the diameter is larger than that of conventional M3 variants. This improves the contact surface and enables the extremely light, rigid construction. This supports the functionality of the measuring sensor - allows the highest possible accuracy.



### Measuring and scanning with the ZEISS VAST XXT measuring sensor

The ZEISS VAST XXT measuring sensor combines the benefits of a rotating sensor with scanning capability. Compared to single point sensors, it not only provides increased measurement accuracy and operational reliability, but also scans the workpiece features to report form deviation and functional size. The extremely lightweight, bending- and torsion-resistant ZEISS REACH CFX® 1, M3 XXT extensions meet the demand for maximum accuracy.

### New Name - Same Performance

ZEISS has completely converted all M3 XXT extensions to carbon fiber extensions, as metals do not meet the requirements for measuring applications. The former ZEISS ThermoFit M3 XXT extensions will run under the name ZEISS REACH CFX® 1 M3 XXT. You get the same high quality and performance under a new name.



# ZEISS REACH CFX® 1, M3 XXT

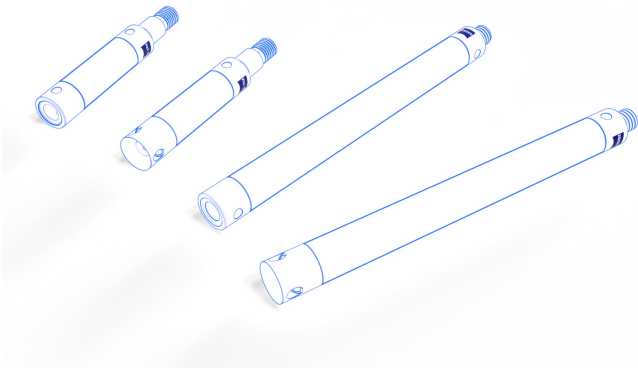

ZEISS REACH CFX® 1, M3 XXT extensions have been specially developed for the ZEISS VAST XXT measuring sensor. The extensions are made of carbon fiber tubes that are wound exclusively for ZEISS. The main focus of these extensions is on the lowest possible weight. Their diameter of five millimeters is larger than that of conventional M3 variants. This improves the contact surface and enables the extremely light, rigid construction. This supports the functionality of the measuring sensor - in terms of the highest possible accuracy. ZEISS REACH CFX® 1, M3 XXT extensions are not recommended for use in M5 systems.

## M3 XXT Extension Ø5, ZEISS REACH CFX® 1

Thermally stable standard extension REACH CFX® 1 M3 XXT are specially developed for the ZEISS VAST XXT sensor. The combination of rigidity and low weight enables the optimal accuracy.

Consisting of:  
 Ø5 mm CFX® 1 carbon fiber tube  
 Titanium adapters with M3 screw and hole for connecting additional components

Connection Type: M3 XXT  
 Ø Body (DG): 5  
 Material: Carbon Fiber



Article-No.	L	System out
626103-5020-000	20.00	M3 XXT
626103-5025-000	25.00	M3 XXT
626103-5030-000	30.00	M3 XXT
626103-5040-000	40.00	M3 XXT
626103-5045-000	45.00	M3 XXT
626103-5050-000	50.00	M3 XXT
626103-5060-000	60.00	M3 XXT
626103-5065-000	65.00	M3 XXT
626103-5075-000	75.00	M3 XXT
626103-5080-000	80.00	M3 XXT
626103-5090-000	90.00	M3 XXT
626103-5100-000	100.00	M3 XXT
626103-5105-000	105.00	M3 XXT
626103-5130-000	130.00	M3 XXT
626103-5140-000	140.00	M3 XXT
626103-5150-000	150.00	M3 XXT

### M3 XXT Extension Ø5 with adapter for rotatable elements, ZEISS REACH CFX® 1

Thermally stable standard extension REACH CFX® 1 M3 XXT are specially developed for the ZEISS VAST XXT sensor. The combination of rigidity and low weight enables the optimal accuracy. With a cone receiver for connecting rotatable components or angle pieces that can be locked to specific angles.



Consisting of:

Ø5 mm CFX® 1 carbon fiber tube

Titanium adapters with M3 screw and cone receiver for connecting rotatable components

Connection Type: M3 XXT

Ø Body (DG): 5

Material: Carbon Fiber

Article-No.	L	System out
626103-5020-005	21.00	Cone Receiver
626103-5025-005	26.00	Cone Receiver
626103-5030-005	31.00	Cone Receiver
626103-5040-005	41.00	Cone Receiver
626103-5050-005	51.00	Cone Receiver
626103-5060-005	61.00	Cone Receiver
626103-5070-005	71.00	Cone Receiver
626103-5080-005	81.00	Cone Receiver
626103-5100-005	101.00	Cone Receiver

### M3 XXT Extension Ø5 with clamping cylinder for rotatable elements, ZEISS REACH CFX® 1

Thermally stable standard extension REACH CFX® 1 M3 XXT are specially developed for the ZEISS VAST XXT sensor. The combination of rigidity and low weight enables the optimal accuracy. With a clamping cylinder for rotatable elements such as cubes or stars that can be locked to specific angles.

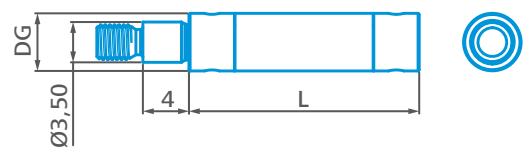

Consisting of:

Ø5 mm CFX® 1 carbon fiber tube

Titanium adapters with M3 screw and clamping cylinder for connecting rotatable components

Connection Type: M3 XXT

Ø Body (DG): 5

Material: Carbon Fiber

Article-No.	L	System out
626103-5020-010	20.00	M3 XXT
626103-5025-010	25.00	M3 XXT



Article-No.	L	System out
626103-5030-010	30.00	M3 XXT
626103-5045-010	45.00	M3 XXT

### M3 XXT Extension Ø5 with clamping cylinder and adapter for rotatable elements, ZEISS REACH CFX® 1

Thermally stable standard extension REACH CFX® 1 M3 XXT are specially developed for the ZEISS VAST XXT sensor. The combination of rigidity and low weight enables the optimal accuracy. With a cone receiver for connecting rotatable components or angle pieces that can be locked to specific angles. Also with a clamping cylinder for rotatable elements such as cubes or stars that can be locked to specific angles.

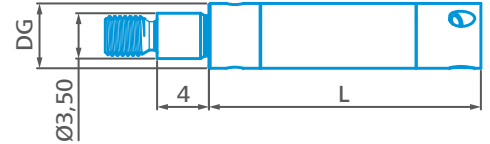

Consisting of:

Ø5 mm CFX® 1 carbon fiber tube

Titanium adapters with cone receiver and clamping cylinder for connecting rotatable components

Connection Type: M3 XXT

Ø Body (DG): 5

Material: Carbon Fiber

Article-No.	L	System out
626103-5020-015	21.00	Cone Receiver
626103-5045-015	46.00	Cone Receiver

## M3 REN extensions

M3 extensions suitable for M3 tactile sensors



Extensions with an M3 thread are suitable for ZEISS RST and M3 sensors from other manufacturers. The portfolio includes extensions made of stainless steel or titanium with eight lengths to choose from.

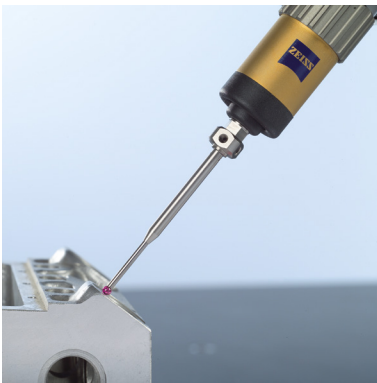

### ZEISS RST single point measuring sensor systems

The RST sensor is known for its fast and dynamic capture of measurement data through single-point probing, free from stylus bending and mechanical hysteresis.

### Stainless steel and titanium extensions

M3 extensions made of stainless steel or titanium are suitable for measuring tasks where the mass of the extension is not influential. The probing force, permissible stylus weight and accessibility determine which extension is suitable for each measuring task. In particular, difficult-to-access holes and deep measuring points would require an extension. The deflection varies depending on the shaft diameter and length, and is important when selecting the extension. M3 extensions are suitable for ZEISS RST, but also for M3 sensors from other manufacturers.





## Extension Ø4, Inox, M3 (touch-trigger)

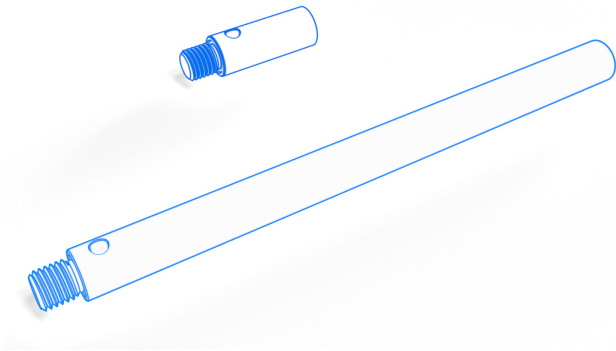

Standard M3 extensions have a smaller outer diameter of 4 mm compared to the 5 mm diameter used with the ZEISS M3 XXT system. The resulting loss of rigidity is compensated for by the use of a stable stainless steel rod. However the weight of the extensions is significantly higher compared to the carbon fiber used in the ZEISS M3 XXT system

### M3 Extension Ø4, Inox

M3 extensions with a 4 mm diameter have been specially developed for use with M3 sensors. These extension are not recommended for the ZEISS VAST M3 XXT sensor.

Consisting of:

Ø4 mm solid Stainless Steel

M3 screw and hole for connecting additional components

Connection Type: M3

Ø Body (DG): 4

Material: Steel



Article-No.	L	System out
602030-8301-000	10.00	M3
602030-8302-000	20.00	M3
602030-8303-000	30.00	M3
602030-8304-000	40.00	M3
602030-8305-000	50.00	M3
626117-4060-201	60.00	M3
626117-4080-202	80.00	M3

## Extension Ø4, Titanium, M3 (touch-trigger)

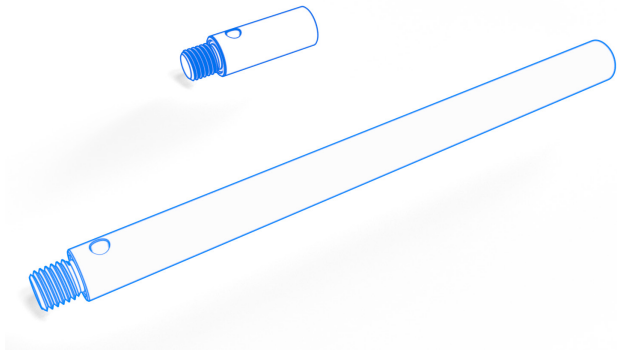

Standard M3 extensions have a smaller outer diameter of 4 mm compared to the 5 mm diameter used with the ZEISS M3 XXT system. The resulting loss of rigidity is compensated for by the use of a stable titanium rod. The weight of these extensions is lower than comparable extensions made of stainless steel, but still significantly higher than ZEISS M3 XXT systems

### M3 Extension Ø4, Titanium

M3 extensions with a 4 mm diameter have been specially developed for use with M3 sensors. These extension are not recommended for the ZEISS VAST M3 XXT sensor.

Consisting of:  
 Ø4 mm solid Titanium  
 M3 screw and hole for connecting additional components

Connection Type: M3  
 Ø Body (DG): 4  
 Material: Titanium



Article-No.	L	System out
626117-4070-300	70.00	M3



## M2 extensions

M2 extensions suitable for M2 tactile sensors



Extensions with an M2 thread are suitable for M2 sensor from other manufacturers. The portfolio includes extensions made of stainless steel with five lengths to choose from.

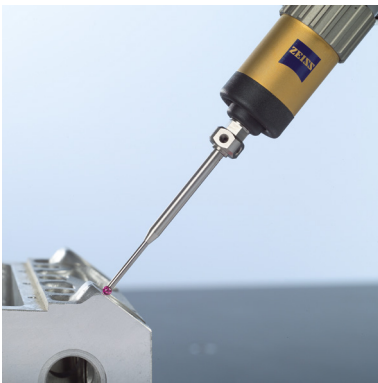

### M2 single point measuring sensor systems

M2 sensor systems are available from other manufactures

### Stainless steel and titanium extensions

M2 extensions made of stainless steel or titanium are suitable for measuring tasks where the mass of the extension is not influential. The probing force, permissible stylus weight and accessibility determine which extension is suitable for each measuring task. In particular, difficult-to-access holes and deep measuring points would require an extension. The deflection varies depending on the shaft diameter and length, and is important when selecting the extension. M2 extensions are suitable for M2 sensors from other manufacturers.



## Steel standard extensions (Inox)

Steel extensions are very rigid, but come at a cost of relatively high weight. Therefore, they should only be used in stylus systems with short horizontal extensions and few added styli

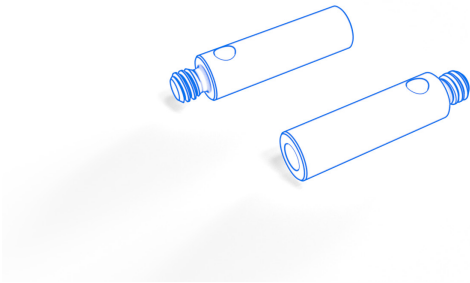

### M2 Extension Ø3, Inox

M2 extensions with a 3 mm diameter have been specially developed for use with M2 sensors. These extension are not recommended for the ZEISS VAST M3 XXT sensor.

Consisting of:  
 Ø3 mm solid Stainless Steel  
 M2 screw and hole for connecting additional components

Connection Type: M2  
 Ø Body (DG): 3  
 Material: Steel



Article-No.	L	System out
602030-8321-000	5.00	M2
602030-8322-000	10.00	M2
602030-8323-000	20.00	M2
602030-8324-000	30.00	M2
602030-8325-000	40.00	M2

# CMM Adapter Plates

ZEISS adaptor plates of the highest quality are the connection to the probe sensor



The adapter plate is an important interface between the CMM and the workpiece. Particularly at the measuring sensor, no compromises should be made. ZEISS adapter plates are manufactured exclusively by ZEISS in Germany under strict quality testing and procedures. Laboratory approvals and constant quality and process control guarantee full functionality on all ZEISS CMMs.



## Avoid incorrect measurements and incorrect operation

With an integrated ID chip in the measuring software, ZEISS adapter plates identify the stylus system and thus prevent operating errors and incorrect measurements.

Another exclusive advantage: With the ZEISS adapter plates, more information such as measuring force or angle of the active probe system is available on the ZEISS control panel display. Adapter plates are specifically engineered to suit ZEISS sensors: ZEISS VAST, VAST XXT, XTR, RDS or ST/ST3.

## Accelerate stylus change and measuring time

"Only ZEISS original adapter plates will support features such as a Quick Change and FlyScan to shorten your inspection time.

The Quick Change function allows you to perform stylus system changes up to 60% faster, thus saving you up to 14 seconds per stylus change. This is more impactful for complex workpieces that require several stylus changes.

The "FlyScan" function allows the stylus to move over a recess gap and continue scanning on the other side without interruption while software evaluates the correct measuring points. Depending on the workpiece, this process can save up to 70% of the measuring time.

Note: for accuracy reasons and system compatibility, these performance optimizations are only possible with original ZEISS adapter plates."



## ZEISS VAST/VAST Gold

Adapter plates for the VAST/VAST Gold sensor with activated chip functions and M5 connection thread

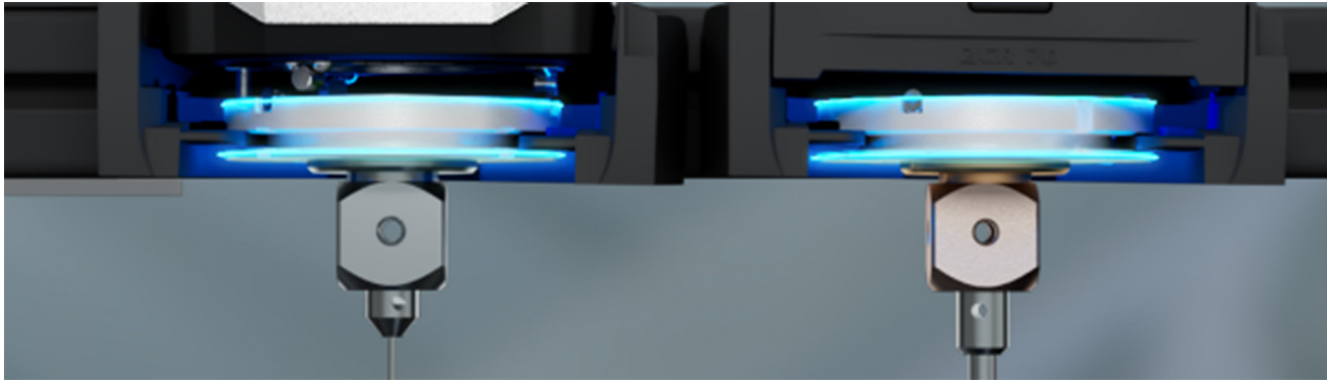

ZEISS adapter plates are specifically engineered for the ZEISS VAST and VAST gold sensors. These sensors are capable of tactile scanning and single point measurements with lengths up to 800 millimeters and weights up to 800 grams, all while maintaining accuracy and high scanning speeds. Of course, this performance also places special demands on the accessories used. The VAST or VAST Gold Sensor and the adapter plate form this technical unification. Advanced software and machine functions are achieved by the integrated chip. New controls such as the ZEISS C99m require these ZEISS adapter plates.

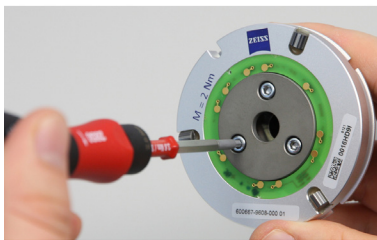

### Cleaning and care

To ensure optimum functionality, care must be taken when dealing with measuring equipment accessories. It is recommended to inspect the adapter plates regularly, if possible under the microscope, for damage and contamination. The receiving rollers are the most critical part since they represent the connection to the measuring sensor, any damage or contamination therefore influences the measuring result.

Please note during installation: The rotary position of the changeover plate is adjusted via three screws on the top side. These may be tightened with a maximum torque of 2 Nm. Too small holding forces lead to the connection becoming detached over time, too great forces lead to a deformation of the aluminum body. To avoid this, the use of a torque wrench is recommended.

### No compromises

The adapter plate connects the stylus system to the probe sensor and is therefore the central interface between the CMM and the workpiece. This is where no compromises should be made. Only with ZEISS adaptor plates can the machine specifications be achieved. With laboratory-tested ZEISS adaptor plates you can achieve the full potential of your CMM.



# Reference adapter plate VAST/VAST Gold

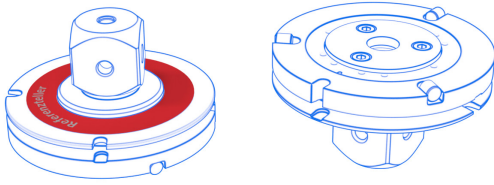

Reference adapter plates are used for the qualification of the machine and to define the reference sphere position. The reference adapter plates are marked with a red ring and should not be used for standard measurements. Suitable for probe heads VAST XT Gold, VAST Gold, VAST C-G1 and VAST XTR Gold (no rotation function).

## Reference adapter plate VAST/VAST Gold

Reference adapter plates are used to define the reference sphere position. Reference adapter plates are used to define the reference sphere position. The reference adapter plates are marked with a red ring and should not be used for standard measurements. Suitable for probe sensors VAST XT Gold, VAST Gold, VAST C-G1 and VAST XTR Gold (no rotation function).

Consists of:

- Aluminum base body with chip (marked red)
- Anchor plate with 3 fastening screws
- Titanium 22 mm cube with M5 threads

Connection Type: M5  
Measuring Sensor: VAST/MT

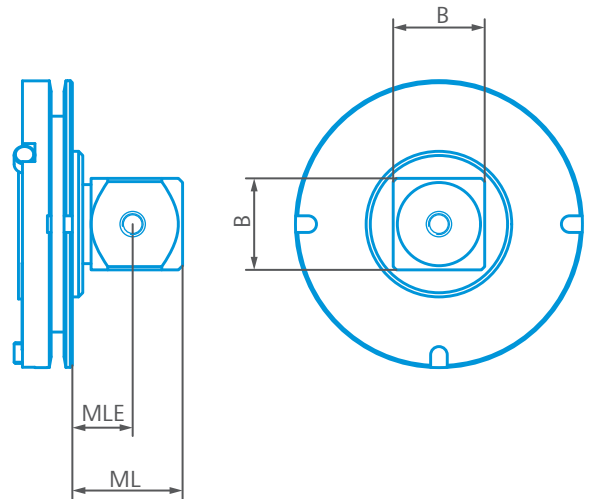

Article-No.	ML	MLE	B	System out
600667-9602-000	26.50	14.50	22.00	M5

## Adapter plates VAST/VAST Gold Standard

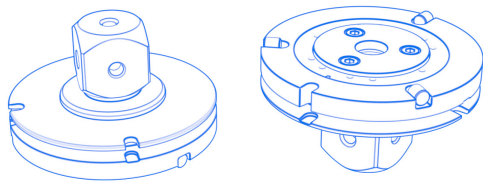

Standard VAST adapter plates are the most frequently used adapter plates. They consist of the actual basic plate body and a direct adaptation in the Z direction or of a screwed-on 22 mm cube. The adaptation to the measuring head takes place via 3 rollers and the central armature plate. The built-in chip enables the use of the entire functional scope of the machine. Via the direct adaptation or the cube with M5 thread, buttons and extensions can be adapted in the Z direction or in all main axes. The adapter plates can be adjusted in the angle of rotation by means of 3 screws in the anchor plate. Usable for measuring heads VAST XT gold, VAST gold, VAST C-G1 and VAST XTR Gold (no rotation functionality).

### Adapter plates VAST/VAST Gold with cube

Standard adapter plates are used on VAST/VAST Gold measuring sensors for all applications. Extensions and styli can be adapted via the cube in all axis directions .

The adaptation of a plate extension instead of the inserted cube results in a greater distance between the plate and laterally adapted elements with simultaneously high static and dynamic stiffness. You can find extensions in the "Extensions" section.

Consists of:

Aluminum base body with chip

Anchor plate with 3 fastening screws

Titanium 22 mm cube with M5 threads

Connection Type: M5

Measuring Sensor: VAST/MT

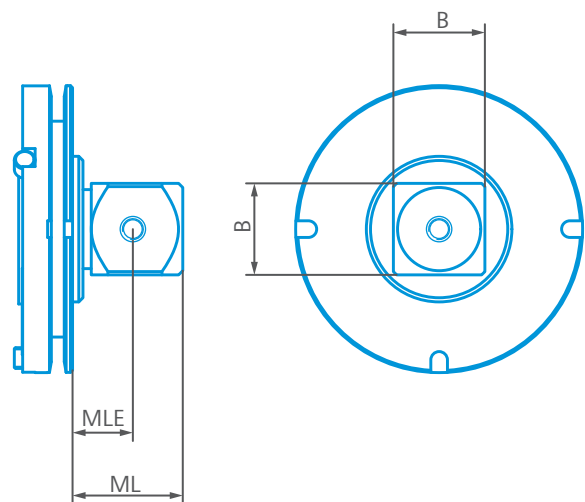

Article-No.	ML	MLE	B	System out
600667-9611-000	26.50	14.50	22.00	M5
600667-9612-000	26.50	14.50	22.00	M5
626119-0001-100	26.50	14.50	22.00	M5
626119-0001-103	26.50	14.50	22.00	M5



## Adapter plates VAST/VAST Gold Pro

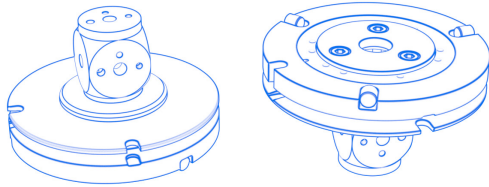

These adapter plates are comparable to the standard adapter plates. Instead of an M5 thread, however, they also have M5 pro index holes, so that all elements from the M5 pro system can be connected. They can of course also be used for all standard M5 elements. They consist of the base body and direct adaptation with M5 threads and index holes in the Z direction or a 22 mm cube with M5 threads and index holes for receiving M5 and M5 pro elements. Usable for measuring heads VAST XT gold, VAST gold, VAST C-G1 and VAST XTR Gold (no rotation functionality)

### Adapter plates VAST/VAST Gold, single cube, M5 Pro

M5 Pro adapter plates with cube are used on VAST/VAST Gold measuring sensors for both standard applications and as a basis for the M5 Pro elements. The M5 Pro system is based on a precisely fitting plug-in connection, which guarantees reproducible and fast assembly as well as torsion-proof applications. Extensions and styli can be adapted via the cube in all axis directions.

Using M5 Pro cubes, the M5 Pro element can only be adapted on one side due to the through-bolt screw. For opposite or 90° adaptations, a double cube with offset bores is required.

Consists of:

Aluminum base body with chip

Anchor plate with 3 fastening screws

Titanium 22 mm cube with M5 Pro index holes and M5 threads

Connection Type: M5 Pro

Measuring Sensor: VAST/MT

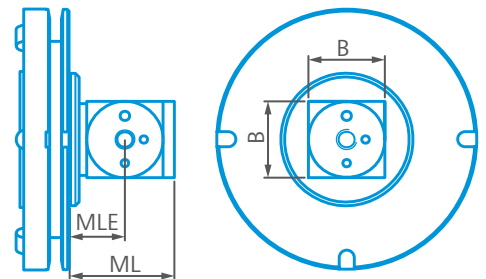

Article-No.	ML	MLE	B	System out
626107-2000-961	27.70	14.60	20.20	M5 Pro

### Adapter plate VAST/VAST Gold, double cube, M5 Pro, connections offset

M5 Pro adapter plates with double cube are used on VAST/VAST Gold measuring sensors for both standard applications and as a basis for the M5 Pro elements. The M5 Pro system is based on a precisely fitting plug-in connection, which guarantees reproducible and fast assembly as well as torsion-proof applications. Extensions and styli can be adapted via the cube in all axis directions.

M5 Pro elements can also be adapted to be opposite or at an angle of 90° due to the offset bores in these double cubes.

Consists of:

Aluminum base body with chip

Anchor plate with 3 fastening screws

Titanium double 22 mm cube with M5 Pro index holes and M5 threads

Connection Type: M5 Pro

Ø Body (DG): 20

Measuring Sensor: VAST/MT

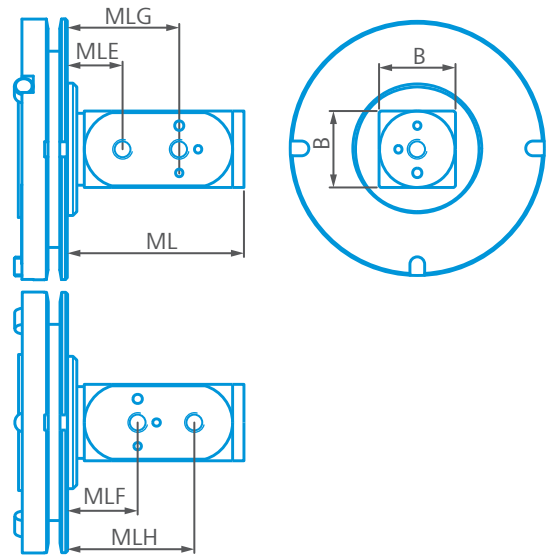

Article-No.	ML	MLE	MLF	MLG	MLH	B	System out
626107-2000-963	46.70	14.60	18.6	29.6	33.6	20.20	M5 Pro

### Adapter plates VAST/VAST Gold standard with M5 Pro adaption

Standard adapter plates with M5 Pro connection are used on VAST/VAST Gold measuring sensors for all applications. An adapter plate without a cube makes it possible to adapt a wide variety of elements directly to the plate. This increases the overall rigidity of the system by bringing the elements closer to the measuring sensor. These plates are usually used together with special angle or beam elements.

Consists of:

Aluminum base body with chip

Anchor plate with 3 fastening screws

Titanium insert with M5 Pro index holes and M5 threads

Connection Type: M5 Pro

Ø Body (DG): 20

Measuring Sensor: VAST/MT

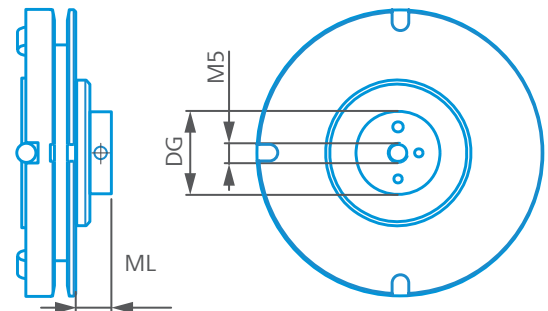

Article-No.	ML	System out
626107-2000-940	8.50	M5 Pro



## Adapter plates for RST-T temperature probe head

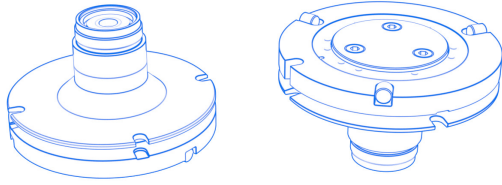

Adapter plates for RST-T probe heads are used for temperature measurement via the probe sensor. They consist of the actual VAST/VAST Gold base body and an interface to the RST-T temperature probe. This can be easily connected to the interface and programmed in the measurement system. The data transmission takes place via the adapter plate interface. Temperature measurements of the workpiece via the probe sensor are predominantly used in automation solutions where manual feeding of a magnetic sensor is not feasible. However, the total measuring time of the workpiece increases due to the required probe change. Suitable for measuring heads VAST XT gold, VAST gold, VAST C-G1 and VAST XTR Gold (no rotation functionality). For temperature measurement, a temp unit must be present in the control unit.

### Adapter plates for RST-T temperature probe head

The workpiece temperature measurement can be easily integrated into the CALYPSO measurement plan via the RST-T temperature probe sensor. This adapter plate enables a simple connection of the RST-T to the VAST/VAST Gold measuring sensor. The RST-T probe is not included in the scope of delivery of this adapter plate.

Consists of:

Aluminum base body with chip

Anchor plate with 3 fastening screws

Adaptor for RST-T probe head

Measuring Sensor: RST-T

**Article-No.**

600667-9603-000

**System out**

RST

## ZEISS VAST XTR

Adapter plates for the VAST XTR sensor have additional bearing seats to allow the rotation function of the plate. Connection thread is M5

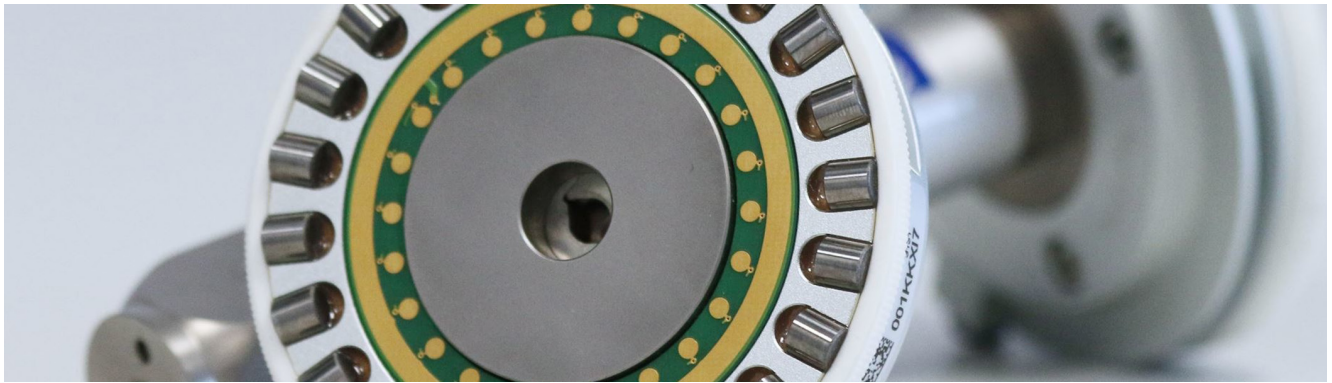

ZEISS adapter plates are specifically engineered for the ZEISS VAST XTR gold sensor. This sensor has an integrated axis of rotation allowing the probe to align in the direction of the feature to be measured. ZEISS VAST XTR gold is based on the design of the ZEISS VAST XT gold and fully supports the VAST navigator and VAST performance features. This performance also places special demands on the accessories used. The VAST or VAST Gold Sensor and the adapter plate form this technical unification. Advanced software and machine functions are achieved by the integrated chip. New controls such as the ZEISS C99m require these ZEISS adapter plates.

### Cleaning and care

In order to ensure optimum functionality, care must of course be taken when dealing with these measuring equipment accessories. It is recommended to inspect the adapter plates regularly, if possible under the microscope, for damage and contamination. The receiving rollers are the most critical part, since they represent the connection to the measuring head, any damage or contamination therefore influences the measuring result.

Please note during assembly: The rotating position of the inner plate is adjusted via three screws on the top side. These may be tightened with a maximum torque of 2.5 Nm. Too little, holding forces may lead to the connection becoming detached over time. Too great, forces lead to a deformation of the aluminum body. To avoid this, the use of a torque wrench is recommended.

### No compromises

The adapter plate connects the stylus system to the probe sensor and is therefore the central interface between the CMM and the workpiece. This is where no compromises should be made. Only with ZEISS adaptor plates can the machine specifications be achieved. With laboratory-tested ZEISS adaptor plates you can achieve the full potential of your CMM.



# Adapter plates VAST XTR with cube

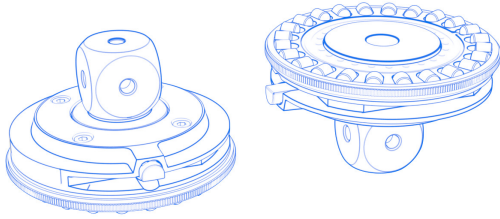

Standard XTR adapter plates are analogous to the standard VAST adapter plates, due to the larger number of receiving rollers, the plate can always be aligned in the direction of the feature to be measured by the integrated axis of rotation. The built-in chip enables the use of the entire functional scope of the machine. They consist of the actual basic XTR plate body and a direct adaptation in the Z direction or a screwed-on 22 mm cube. Via these interfaces, styli and extensions can be adapted in the Z direction or in all main axes. The adapter plates can be adjusted in the angle of rotation by means of 4 screws on the underside of the plate. Standard adapter plates can be used for most applications on the VAST XTR Gold probe.

## Adapter plates VAST XTR with cube

Standard XTR adapter plates are used on VAST XTR measuring sensors for all applications. The sensor system can be rotated in 15° steps via the built-in rotation axis on the XTR measuring sensor. Extensions and connections in all major axis directions can be adapted via the cube.

Consisting of:

Aluminum XTR base body with chip

Anchor plate with 4 fastening screws

Titanium 22 mm cube with M5 threads

Connection Type: M5

Measuring Sensor: VAST XTR

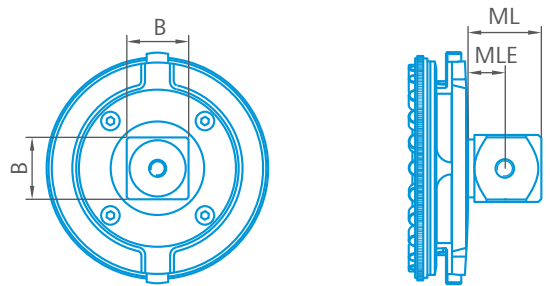

Article-No.	ML	MLE	B	System out
600664-9700-000	22.78	11.78	22.00	M5

## Adapter plates VAST XTR Pro

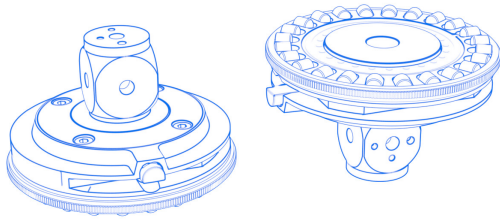

These adapter plates are comparable to the standard XTR adapter plates. Instead of an M5 thread, however, they also have M5 pro index holes, so that all elements from the M5 pro system can be connected. They can also be used for all standard M5 elements. They consist of the XTR base body and direct adaptation with M5 threads and index holes in the Z direction or a 22 mm cube with M5 threads and index holes for receiving M5 and M5 pro elements. Usable for measuring head VAST XTR Gold

### Adapter plates VAST XTR with cube M5 Pro

XTR adapter plates with M5 Pro dice are used on VAST/VAST Gold measuring sensors for both standard applications and as a basis for the M5 Pro elements. The sensor system can be rotated in 15° steps via the built-in rotation axis on the XTR measuring sensor. The M5 Pro system is based on a precisely fitting plug-in connection that guarantees reproducible and fast assembly as well as torsion-proof applications. Extensions and connections in all major axis directions can be adapted via the cube.

For individual cubes, M5 per element can only be adapted on one side due to the through-bolt. For opposite or 90° adaptations, a double cube with offset bores is required.

Consisting of:

Aluminum XTR base body with chip

Anchor plate with 4 fastening screws

Titanium 22 mm cube with M5 threads and Index holes

Connection Type: M5 Pro

Ø Body (DG): 20

Measuring Sensor: VAST XTR

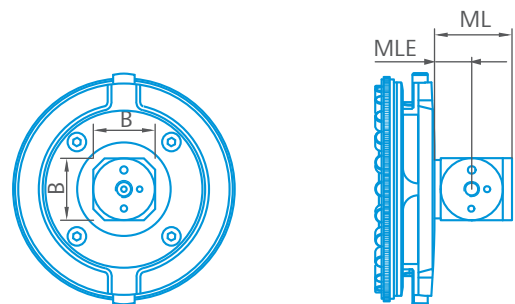

Article-No.	ML	MLE	B	System out
626107-7000-961	24.86	11.76	20.20	M5 Pro



# VAST XXT

Adapter plates for the VAST XXT sensor are significantly smaller and lighter than other adapter plates. Connecting thread is M3



ZEISS adapter plates are specifically engineered for the ZEISS VAST XXT sensor. As an alternative to changing the styli system, the ZEISS VAST XXT rotates to a feature's angle and increases the operational efficiencies and reliability of the measurements. This method also offers scanning functionality and accounts for form deviations of the measured elements. The refined bearing points of the XXT adapter plate ensures system stability a high degree of accuracy at the same time. Gold-plated contact points improve the electrical conductivity, which ensures a more robust data transmission. Since 2022, the VAST XXT adapter plates have been equipped with a new chip, which will in the future, enable similar benefits as the VAST measuring sensor regarding increase performance and integrate new features.

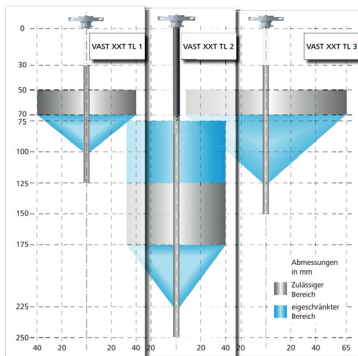

## Different types of VAST XXT

When assembling probe systems, the limitations of the VAST XXT measuring sensor must be observed diligently with respect to length and weight. For TL1, TL2 and TL4, the maximum weight including the adapter plate is 10 grams. For TL3 the max weight is 15 grams. The permitted lengths (in all axes) also differ according to the different sensors. Optionally, the adapter plates are already equipped with an extension and cube aligned in machine axes. A cone receiver is also available that allows a wide variety of rotatable connecting elements that can be inserted and simply aligned.

## No compromises

The adapter plate connects the stylus system to the probe sensor and is therefore the central interface between the CMM and the workpiece. This is where no compromises should be made. Only with ZEISS adaptor plates can the machine specifications be achieved. With laboratory-tested ZEISS adaptor plates you can achieve the full potential of your CMM.



## Adapter plates VAST XXT TL1

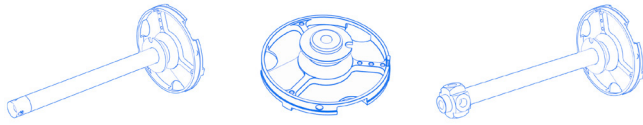

ZEISS VAST XXT TL1 measuring heads are the most sensitive measuring heads in the VAST XXT series. They are limited in weight with respect to the load-bearing capacity and in the maximum lengths in the X, Y and Z directions. They are commonly used for the O-INSPECT.

Probe systems on VAST XXT TL1 sensor allow a vertical length range of 30-125 mm, horizontal max length of 40 mm, and a maximum weight of 10 grams including the adaptor plate.

### Reference adapter plate VAST XXT TL1

Reference adapter plates are used to define the reference sphere position. The reference adapter plates are marked with a red dot and should not be used for standard measurements. Suitable for probe sensors VAST XXT TL1.

Consisting of:  
 Aluminum base body (marked in red) with chip  
 Mounting magnet  
 Gold coated contact spheres  
 Titanium insert with M3 thread

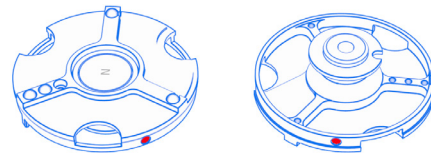

Connection Type: M3 XXT  
 Measuring Sensor: VAST XXT TL1

Article-No.	System out
620161-8259-000	M3 XXT

### Adapter plates VAST XXT TL1 Standard

These adapter plates with M3 XXT connection are used on VAST XXT TL1 measuring sensors for all applications. An adapter plate without a cube makes it possible to adapt a wide variety of elements directly to the plate.

Consisting of:  
 Aluminum base body with chip  
 Mounting magnet  
 Gold coated contact spheres  
 Titanium insert with M3 thread

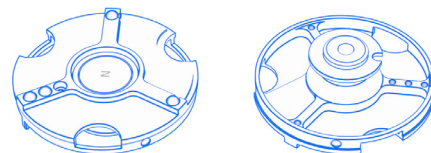

Connection Type: M3 XXT  
 Measuring Sensor: VAST XXT TL1

Article-No.	System out
620161-8254-000	M3 XXT
626119-0001-111	M3 XXT
626119-0001-113	M3 XXT



## Adapter plates VAST XXT TL1 with plate extension and cube

These adapter plates with M3 XXT connection are used on VAST XXT TL1 measuring sensors for all applications. Adapter plates with integrated extension and aligned cube are mainly used to create star probes. The aligned cube ensures that the stylus system is correctly aligned along the machine axes.

- Consisting of:
- Aluminum base body with chip
- Mounting magnet
- Gold coated contact spheres
- Bonded carbon fiber extension with cube with M3 thread
- The cube is aligned with the machine axes

Connection Type: M3 XXT  
 Measuring Sensor: VAST XXT TL1

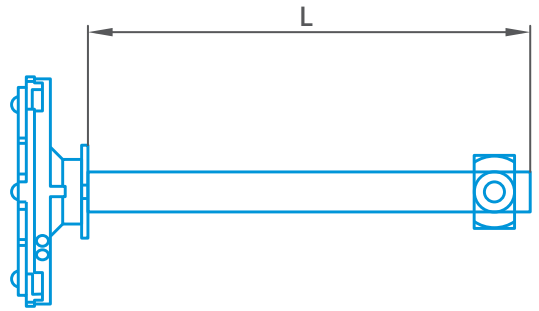

Article-No.	L	System out
626103-8431-055	55.00	M3 XXT
626103-8431-075	75.00	M3 XXT

## Adapter plates VAST XXT TL1 with plate extension and adapter for rotatable elements

These adapter plates with M3 XXT connection are used on VAST XXT TL1 measuring sensors for all applications. Adapter plates with integrated extension and rotation receiver are mainly used for star and other angle elements, which have to be adjusted at a special angle to the machine axes. The conical receiver is used for correctly aligning the rotary elements and for fixing them in a rotationally secure manner.

- Consisting of:
- Aluminum base body with chip
- Mounting magnet
- Gold coated contact spheres
- Bonded carbon fiber extension with receiver for rotating elements

Connection Type: M3 XXT  
 Measuring Sensor: VAST XXT TL1

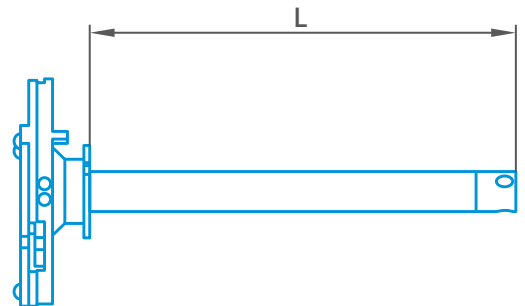

Article-No.	L	System out
626103-8431-053	53.00	Cone Receiver

## Adapter plates VAST XXT TL3

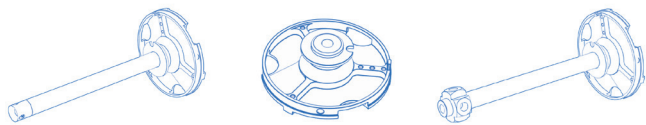

ZEISS VAST XXT TL3 measuring sensors are characterized by their robust construction. In comparison to the TL1, the TL3 can carry 1.5 times more weight and use longer extensions, especially in the horizontal directions. ZEISS VAST XXT TL3 measuring sensors are commonly used in shop floor machines such as the DuraMax.

Probe systems on VAST XXT TL3 sensor allow a vertical length range of 30-150 mm, horizontal max length of 65 mm, and a maximum weight of 15 grams including the adaptor plate.

### Reference adapter plate VAST XXT TL3

Reference adapter plates are used to define the reference sphere position. The reference adapter plates are marked with a red dot and should not be used for standard measurements. Suitable for probe sensors VAST XXT TL3.

Consisting of:

Aluminum base body (marked red) with chip

Mounting magnet

Gold coated contact spheres

Titanium insert with M3 thread

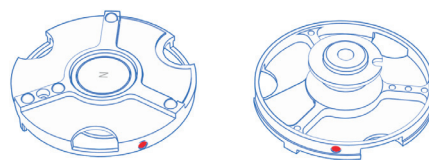

Connection Type: M3 XXT

Measuring Sensor: VAST XXT TL3

#### Article-No.

620161-8279-000

#### System out

M3 XXT

### Adapter plates VAST XXT TL3 Standard

These adapter plates with M3 XXT connection are used on VAST XXT TL3 measuring sensors for all applications. An adapter plate without a cube makes it possible to adapt a wide variety of elements directly to the plate.

Consisting of:

Aluminum base body with chip

Mounting magnet

Gold coated contact spheres

Titanium insert with M3 thread

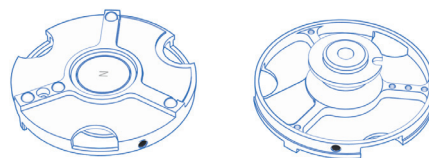

Connection Type: M3 XXT

Measuring Sensor: VAST XXT TL3

#### Article-No.

620161-8274-000

626119-0001-112

626119-0001-114

#### System out

M3 XXT

M3 XXT

M3 XXT



## Adapter plates VAST XXT TL3 with plate extension and cube

These adapter plates with M3 XXT connection are used on VAST XXT TL3 measuring sensors for all applications. Adapter plates with integrated extension and aligned cube are mainly used to create star probes. The aligned cube ensures that the stylus system built on it is correctly aligned along the machine axes.

Consisting of:  
 Aluminum base body with chip  
 Mounting magnet  
 Gold coated contact spheres  
 Bonded carbon fiber extension with cube with M3 thread  
 The cube is aligned with the machine axes

Connection Type: M3 XXT  
 Measuring Sensor: VAST XXT TL3

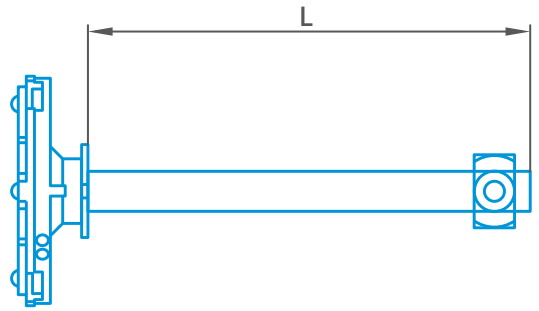

Article-No.	L	System out
626103-8433-055	55.00	M3 XXT
626103-8433-075	75.00	M3 XXT

## Adapter plates VAST XXT TL3 with plate extension and adapter for rotatable elements

These adapter plates with M3 XXT connection are used on VAST XXT TL3 measuring sensors for all applications. Adapter plates with integrated extension and rotation receiver are mainly used for star and other angle elements, which have to be adjusted at a special angle to the machine axes. The conical receiver is used for correctly aligning the rotary elements and for fixing them in a rotationally secure manner.

Consisting of:  
 Aluminum base body with chip  
 Mounting magnet  
 Gold coated contact spheres  
 Bonded carbon fiber extension with receiver for rotating elements

Connection Type: M3 XXT  
 Measuring Sensor: VAST XXT TL3

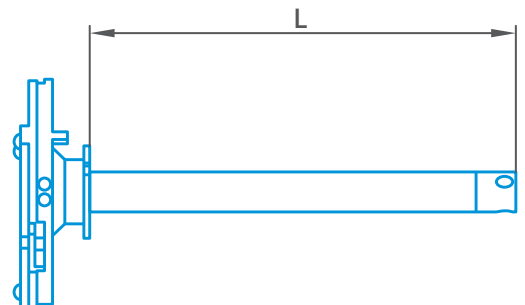

Article-No.	L	System out
626103-8433-053	53.00	Cone Receiver

## Adapter plates VAST XXT TL2/TL4

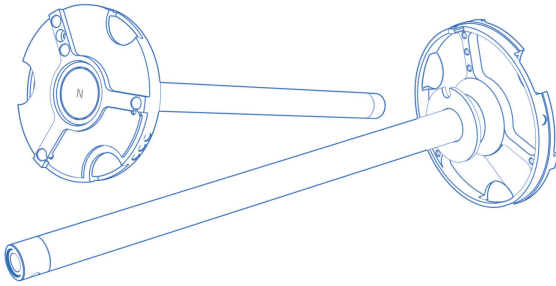

ZEIS VAST XXT TL4 measuring sensors are especially used for higher requirements in the vertical length of the probe systems. They can carry 10 grams of weight, but are limited in the horizontal directions. ZEISS VAST XXT TL4 measuring sensors are used in special applications on all machines.

Probe systems on VAST XXT TL4 sensor allow a vertical length range of 125-250 mm, horizontal max length of 40 mm, and a maximum weight of 10 grams including the adaptor plate.

### Reference adapter plate VAST XXT TL4

Reference adapter plates are used to define the reference sphere position. The reference adapter plates are marked with a red dot and should not be used for standard measurements. Suitable for probe sensors VAST XXT TL4 and TL2.

Consisting of:  
 Aluminum base body (marked red) with chip  
 Mounting magnet  
 Gold coated contact spheres  
 Titanium insert with M3 thread

Connection Type: M3 XXT  
 Measuring Sensor: VAST XXT TL4/TL2

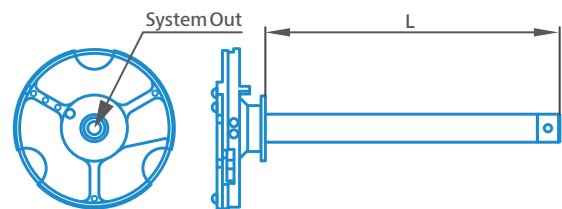

Article-No.	L	System out
620161-8269-000	75.00	M3 XXT

## Adapter plates VAST XXT TL4 Standard

These adapter plates with M3 XXT connection are used on VAST XXT TL4 measuring sensors for all applications. An adapter plate without a cube makes it possible to adapt a wide variety of elements directly to the plate.

Consisting of:  
 Aluminum base body with chip  
 Mounting magnet  
 Gold coated contact spheres  
 Titanium insert with M3 thread

Connection Type: M3 XXT  
 Measuring Sensor: VAST XXT TL4/TL2

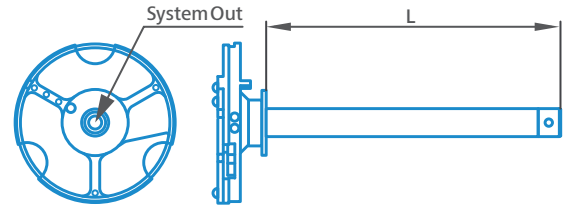

Article-No.	L	System out
620161-8264-000	75.00	M3 XXT

## Adapter plates VAST XXT TL4 with plate extension and adapter for rotatable elements

These adapter plates with M3 XXT connection are used on VAST XXT TL4 measuring sensors for all applications. Adapter plates with integrated extension and rotation receiver are mainly used for star and other angle elements, which have to be adjusted at a special angle to the machine axes. The conical receiver is used for correctly aligning the rotary elements and for fixing them in a rotationally secure manner.

Consisting of:  
 Aluminum base body with chip  
 Mounting magnet  
 Gold coated contact spheres  
 Bonded carbon fiber extension with cube with M3 thread  
 The cube is aligned with the machine axes

Connection Type: M3 XXT  
 Measuring Sensor: VAST XXT TL4/TL2

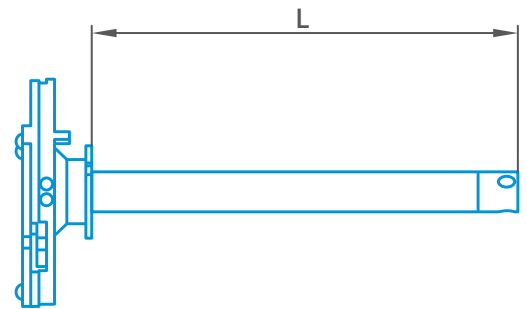

Article-No.	L	System out
626103-8434-076	76.00	Cone Receiver

## Accessories for Adapter Plates

Accessories for adapter plates to protect and identify sensitive stylus systems and to extend functionality



ZEISS also offers accessories for the adapter plate that allow protecting, marking, storing or extending functionality. All products have been checked and approved for original ZEISS adapter plates. Compatibility cannot be guaranteed for older versions or third-party plates



### Protection and labeling elements

Protective elements are attached to the adapter plate and are used to protect the plates and thus the entire stylus system against collisions. Identification labels can also be attached to the adapter plate to clearly identify the stylus system outside the machine.

### Additional features

Additional cube elements are used to convert an existing adapter plate to another system at a low cost, without immediately acquiring the entire plate.

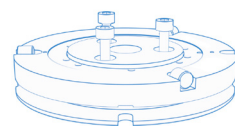



## Collision protection for adapter plates

These protective rings are used to protect the adapter plates from damage during setting-up and measuring operations or during storage. The collision protection rings are made of plastic and are simply slipped over the aluminum body of the adapter plate. This protects the sensitive edges from shocks and extends the life of plates.

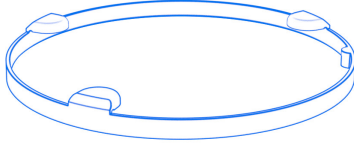

### Collision protection for adapter plates VAST/VAST Gold

Damage to the aluminum base body of the VAST/VAST Gold adapter plate can be caused by shocks or also collisions in the measuring process. In unfavorable cases, such damages can adversely affect the seat of the plate in the measuring sensor and thus the transmission of the measured values. The easy-to-install plastic ring prevents damage to the relevant points on the sensitive adapter plate. Suitable exclusively for VAST/VAST Gold changeover plates

Consisting of:  
Plastic ring

Connection Type: MT/VAST  
Measuring Sensor: VAST/MT

**Article-No.**

600664-8410-000

## Labeling for adapter plates

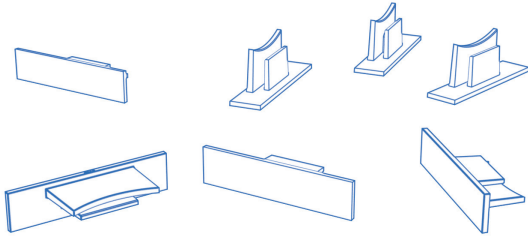

If different stylus systems are used in a measuring program, they must also be noted accordingly in the programming. For this purpose, each stylus system has its own designation, which can be selected by the user. In order to distinguish them from each other, the stylus systems themselves should also be appropriately labeled. To do this, identification labels such as these are simply attached to the adapter plate

## Labeling for VAST/VAST Gold adapter plates

In the CALYPSO measurement sequence, each probe system has its own designation, which can be selected by the user himself. By means of the identification clips, this designation can also be visibly attached to the stylus systems in order to distinguish from one another and to place correctly in the probe rack.

Consisting of:  
Plastic clip

Connection Type: MT/VAST  
Measuring Sensor: VAST/MT

### **Article-No.**

626119-0010-000



# Plate cubes and other adapters

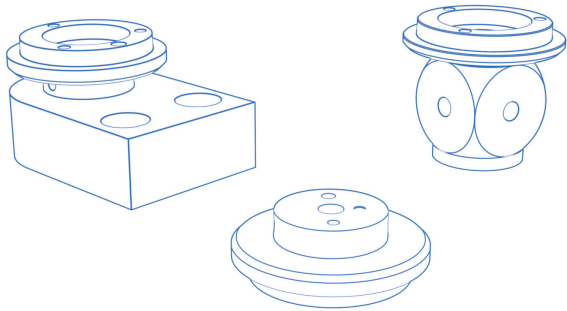

If the existing cube or extension on an adaptor plate is damaged or no longer needed, it is not necessary to replace the complete adapter plate. For this purpose, there are plate cubes and other plate adapters offered as individual components. These can be easily fastened to the plate base body via the 3 screws and the anchor plate. Plate extensions as individual components can be found in the Extensions section

## Adapter-1x-M5 Pro, Adapter plate VAST (XT) gold

Cube and other adapters on VAST/VAST Gold adapter plates are fixed to the plate via 3 screws and are easy to exchange. ZEISS offers a variety of possibilities for adapting different system components to the adapter plates. For this it is necessary to use the correct recording to achieve the desired performance.

Consisting of:  
Titanium adapter without screws

Connection Type: M5 Pro  
Ø Body (DG): 20  
Measuring Sensor: VAST/MT  
Material: Titanium

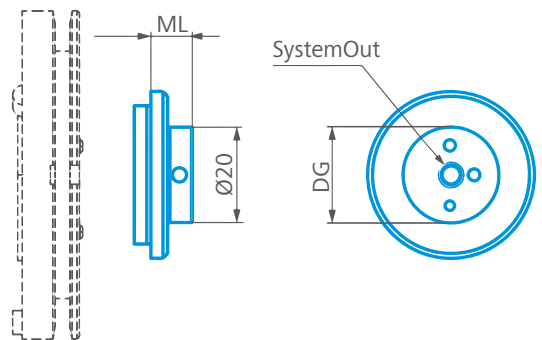

Article-No.	ML	System out
626107-2000-140	8.50	M5 Pro

## Cube-5x-M5 Pro, Adapter plate VAST (XT) Gold

Cube and other adapters on VAST/VAST Gold adapter plates are fixed to the plate via 3 screws and are easy to exchange. ZEISS offers a variety of possibilities for adapting different system components to the adapter plates. For this it is necessary to use the correct recording to achieve the desired performance.

Consisting of:  
Titanium adapter without screws

Connection Type: M5 Pro  
Measuring Sensor: VAST/MT  
Material: Titanium

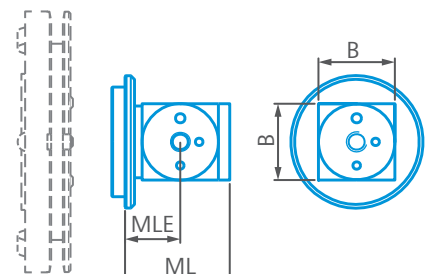

Article-No.	ML	MLE	B	System out
626107-2000-161	27.70	14.60	20.20	M5 Pro



### Cube-9x-M5 Pro, Adapter plate VAST (XT) Gold

Cube and other adapters on VAST/VAST Gold adapter plates are fixed to the plate via 3 screws and are easy to exchange. ZEISS offers a variety of possibilities for adapting different system components to the adapter plates. For this it is necessary to use the correct recording to achieve the desired performance.

Consisting of:  
Titanium adapter without screws

Connection Type: M5 Pro  
Measuring Sensor: VAST/MT  
Material: Titanium

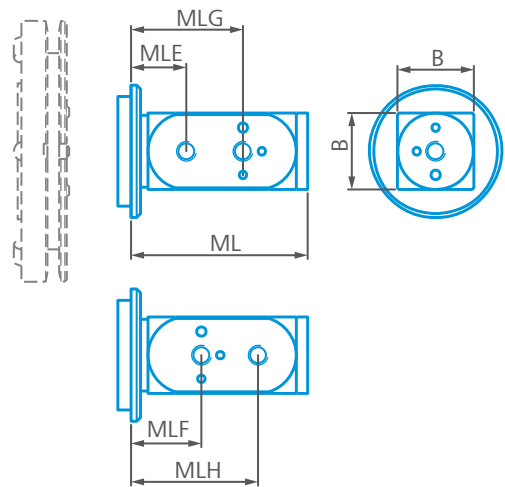

Article-No.	ML	MLE	MLF	MLG	MLH	B	System out
626107-2000-163	46.70	14.60	18.6	29.6	33.6	20.20	M5 Pro

### Adapter multiple holder for MT/VAST

Cube and other adapters on VAST/VAST Gold adapter plates are fixed to the plate via 3 screws and are easy to exchange. ZEISS offers a variety of possibilities for adapting different system components to the adapter plates. For this it is necessary to use the correct recording to achieve the desired performance.

Consisting of:  
Titanium adapter without screws

Measuring Sensor: VAST/MT  
Material: Titanium

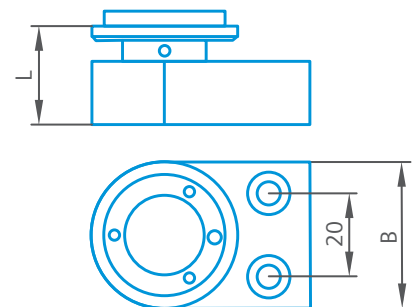

Article-No.	L	B	System out
626107-2000-150	23.50	35.00	M5

## Cube-5x-M5 Pro, Adapter plate VAST XTR

Cube and other adapters on VAST/VAST Gold adapter plates are fixed to the plate via 3 screws and are easy to exchange. ZEISS offers a variety of possibilities for adapting different system components to the adapter plates. For this it is necessary to use the correct recording to achieve the desired performance.

Consisting of:  
Titanium adapter without screws

Connection Type: M5 Pro  
Measuring Sensor: VAST XTR  
Material: Titanium

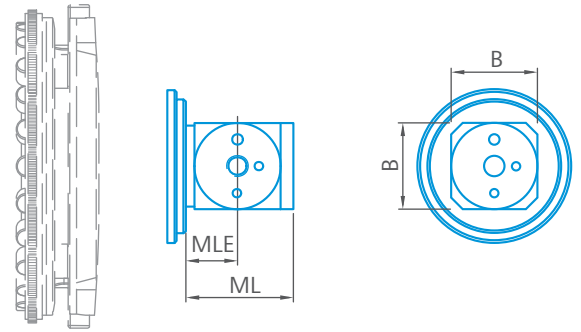

Article-No.	ML	MLE	B	System out
626107-7000-161	24.86	11.76	20.20	M5 Pro

## Cube-9x-M5 Pro, Adapter plate VAST XTR

Cube and other adapters on VAST/VAST Gold adapter plates are fixed to the plate via 3 screws and are easy to exchange. ZEISS offers a variety of possibilities for adapting different system components to the adapter plates. For this it is necessary to use the correct recording to achieve the desired performance.

Consisting of:  
Titanium adapter without screws

Connection Type: M5 Pro  
Measuring Sensor: VAST XTR  
Material: Titanium

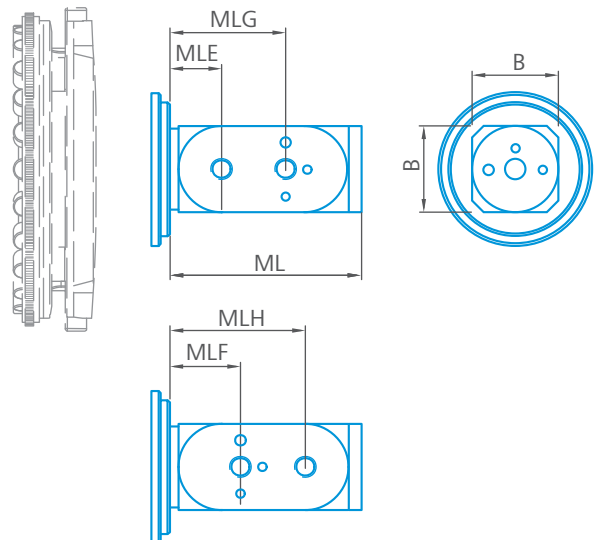

Article-No.	ML	MLE	MLF	MLG	MLH	B	System out
626107-7000-163	44.16	11.76	16.056	26.756	31.056	20.20	M5 Pro



# CMM Connection Elements

ZEISS Connection Elements



Connecting elements are indispensable for the configuration of stylus systems. ZEISS offers products for all applications, from cubes, angle and star elements to screws and counterweights. Here you will find everything you need for a high-end stylus system. All elements of the ZEISS family of connecting elements are technically coordinated and scalable. Here, too, ZEISS guarantees maximum production quality and thus maximum performance.

## ZEISS Rotating Elements

ZEISS cone adapters for all types of rotary elements can be used directly or in combination with a REACH CFX extension. These taper mounts are the basis for all flexible solutions that need to be set to a certain orientation. ZEISS rotary elements and conical mounts are distinguished from conventional solutions by their special design. With little force, angles can be set without play and without deforming the elements. In combination with the corresponding stylus setting devices, complex stylus systems can be set up and set up correctly very quickly and easily.

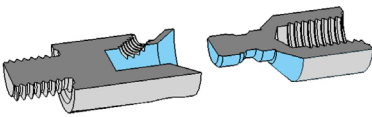

## Variations

Cubes allow you to easily create right-angled combinations and star styli; different angle pieces are available for other settings. Movable elements such as turning or joint pieces are used to set up angled stylus systems. Angle elements with fixed angles are also available for these applications. This allows you to measure features in all spatial angles without any difficulty. Threaded adapters provide the interface between the individual threaded systems. Please note that the adaptation always goes from the large thread to the small thread.



## M5

M5 connecting elements for connecting extensions or probes in a probe system for use on VAST/VAST gold probes



M5 connecting elements are mainly used in VAST stylus systems. Choose from various connecting elements with M5 threads: cone holders, cone inserts, rotating star elements and angles, fixed angles and cubes as well as bending and rotating elements.



### ZEISS connecting elements

The majority of ZEISS connecting elements have built-in cone adapters that can be inserted directly into the swivel mount of an extension. This means that cubes, angle, star, L and T elements can be aligned very easily and quickly. There is no need to adjust the elements using a screw on the base cube.

### ZEISS rotatable angle handpieces

ZEISS rotating angle pieces are made of a high-quality titanium alloy and can accommodate up to 2 styli at the desired angles. In combination with the ZEISS rotating elements, all angle combinations in the room can be achieved. The angle pieces can be manufactured by ZEISS in CNC quality or on site from blanks.

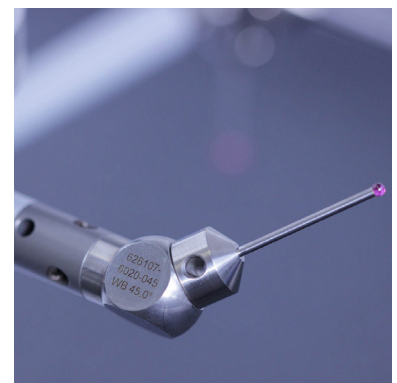

# Knuckles and rotary elements

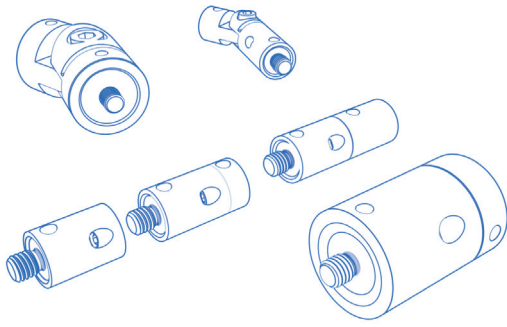

Movable elements such as kink elements are used to create angled stylus combinations. The angle is set transversely to the main axis of the kink element. The rotary kink element is set rotationally with the help of the integrated cone receptacle. This allows you to set any solid angle. The kink element is configured and clamped before it is installed in the stylus system. It is then inserted into the cone receiver and locked at the correct angle of rotation using three set screws. With the aid of the rotary piece, further connecting elements with threaded connection can be set rotationally. This ensures that your stylus system remains flexible.

## Rotary joints basic, M5-CR

Basic swivel elements consist of the actual base element with M5 thread and a cone adapter on the opposite side.

Connection Type: M5  
 Ø Body (DG): 11  
 Material: Titanium

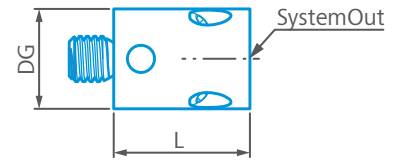

Article-No.	L	System out
626107-1015-105	15.00	Cone Receiver

## Rotary joints complete, DG11, M5-M5

Complete rotary elements consist of the base element and an already connected rotary adapter

Connection Type: M5  
 Ø Body (DG): 11  
 Material: Titanium

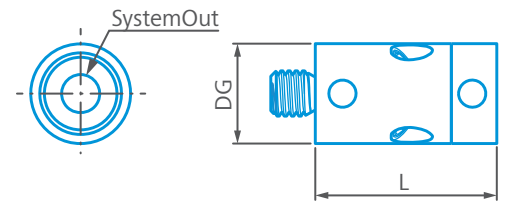

Article-No.	L	System out
626105-6280-020	20.00	M5
626105-6280-030	30.00	M5

## Rotary joints complete, DG20, M5-M5

Complete rotary elements consist of the base element and an already connected rotary adapter

Connection Type: M5  
 Ø Body (DG): 20  
 Material: Titanium

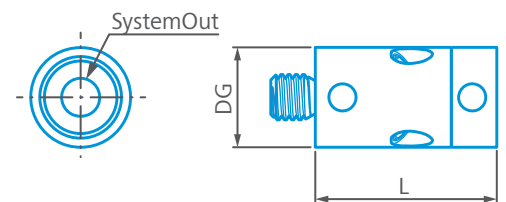

Article-No.	L	System out
626105-6280-090	30.00	M5



### Knuckle joints, DG11, M5-M5

Knuckle elements for free adjustment of one-dimensional angles

Connection Type: M5  
 Ø Body (DG): 11  
 Material: Titanium

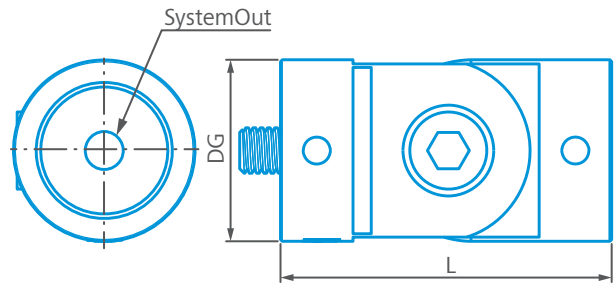

Article-No.	L	System out
600342-9002-000	30.00	M5

### Knuckle joints, DG20, M5-M5

Knuckle elements for free adjustment of one-dimensional angles

Connection Type: M5  
 Ø Body (DG): 20  
 Material: Titanium

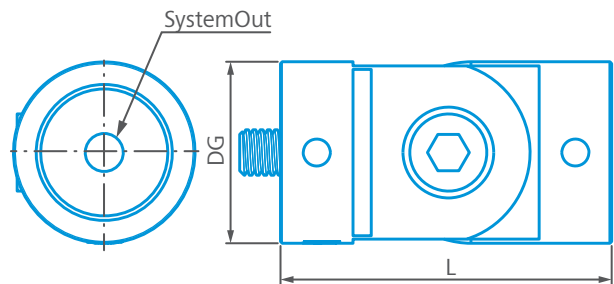

Article-No.	L	System out
626105-6280-070	36.00	M5

### Rotary-knuckle joints, M5-M5

Rotary knuckle elements consist of a basic rotary element and an already connected, rotatable buckling element.

Connection Type: M5  
 Ø Body (DG): 11  
 Material: Titanium

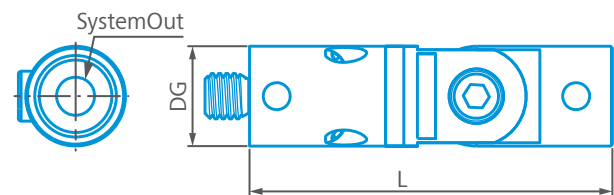

Article-No.	L	System out
626105-6280-040	40.00	M5



# Inserts with cone adapter

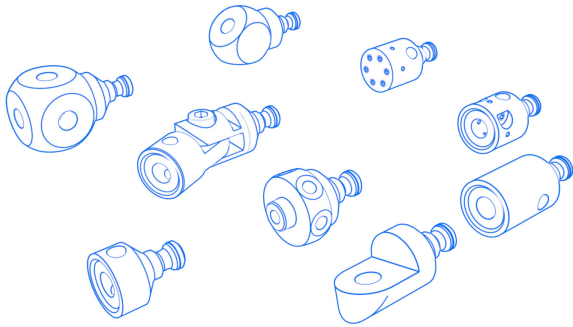

A large number of ZEISS connecting elements have built-in cone adapters that can be inserted directly into the swivel mount of an extension. This allows you to quickly and easily align the cube, end angle, star, L and T elements. This eliminates the need to use a screw on the base cube to adjust the elements.

## Rotary joint, CA-M5

Insert with cone adapter (CA) with M5 connection for setting rotational angles

Connection Type: Cone Adapter  
 Ø Body (DG): 11  
 Material: Titanium

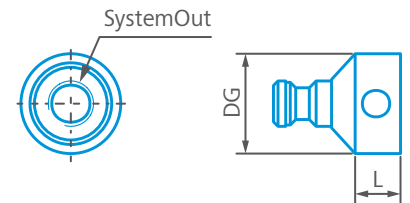

Article-No.	L	System out
626107-6280-020	5.00	M5
626107-6280-030	15.00	M5

## 90° angle piece, CA-M5

90° insert with cone adapter (CA), rotationally adjustable

Connection Type: Cone Adapter  
 Ø Body (DG): 11  
 Material: Titanium

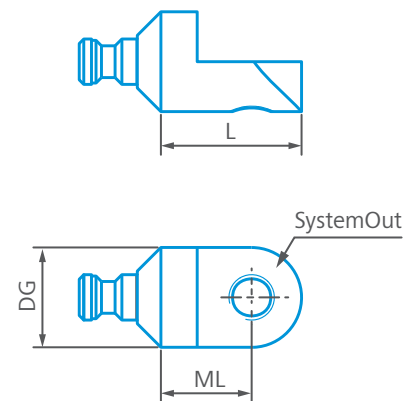

Article-No.	L	ML	B	System out
626107-6280-010	15.50	10.00	5.50	M5

## Single angle pieces, CA-M5

Angle inserts with cone adapter (CA) and fixed milled angle, rotationally adjustable

Connection Type: Cone Adapter

Ø Body (DG): 11

Material: Titanium

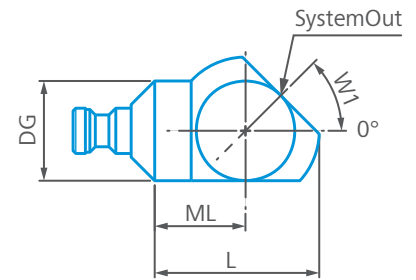

Article-No.	L	ML	W1	System out
626107-6020-569	16.00	10.00	0.10	M5
626107-6020-010	16.00	10.00	10.00	M5
626107-6020-170	16.00	10.00	13.50	M5
626107-6020-015	16.00	10.00	15.00	M5
626107-6020-017	16.00	10.00	17.00	M5
626107-6020-020	16.00	10.00	20.00	M5
626107-6020-023	16.00	10.00	23.00	M5
626107-6020-025	16.00	10.00	25.00	M5
626107-6020-028	16.00	10.00	28.00	M5
626107-6020-030	16.00	10.00	30.00	M5
626107-6020-035	16.00	10.00	35.00	M5
626107-6020-037	16.00	10.00	37.00	M5
626107-6020-004	16.00	10.00	4.00	M5
626107-6020-040	16.00	10.00	40.00	M5
626107-6020-041	16.00	10.00	41.00	M5
626107-6020-044	16.00	10.00	44.00	M5
626107-6020-045	16.00	10.00	45.00	M5
626107-6020-005	16.00	10.00	5.00	M5
626107-6020-050	16.00	10.00	50.00	M5
626107-6020-051	16.00	10.00	51.00	M5
626107-6020-052	16.00	10.00	52.00	M5
626107-6020-006	16.00	10.00	6.00	M5
626107-6020-060	16.00	10.00	60.00	M5
626107-6020-065	16.00	10.00	65.00	M5
626107-6020-007	16.00	10.00	7.00	M5
626107-6020-070	16.00	10.00	70.00	M5
626107-6020-080	16.00	10.00	80.00	M5
626107-6020-085	16.00	10.00	85.00	M5
626107-6020-088	16.00	10.00	88.00	M5
626107-6020-090	16.00	10.00	90.00	M5

## Double angle pieces, CA-M5 (2x)

Angle inserts with cone adapter (CA) and 2 fixed milled angles (double angle), rotationally adjustable

Connection Type: Cone Adapter  
 Ø Body (DG): 11  
 Material: Titanium

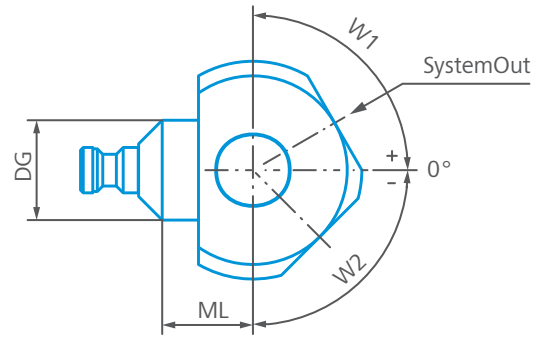

Article-No.	L	ML	W1	W2	System out
626107-6023-011	16.00	10.00	45.00	-45.00	M5
626107-6023-010	16.00	10.00	45.00	-45.00	M3
626107-6023-001	16.00	10.00	30.00	-30.00	M5
626107-6023-005	16.00	10.00	60.00	-60.00	M5
626107-6023-044	16.00	10.00	90.00	-75.00	M5
626107-6023-041	16.00	10.00	60.00	0.00	M5
626107-6023-015	16.00	10.00	90.00	10.00	M5
626107-6023-020	16.00	10.00	49.00	-49.00	M5
626107-6023-028	16.00	10.00	65.00	-65.00	M5
626107-6023-050	16.00	10.00	0.00	77.50	M5
626107-6023-008	16.00	10.00	30.00	-60.00	M5
626107-6023-012	16.00	10.00	40.00	-40.00	M5
626107-6023-017	16.00	10.00	0.00	78.00	M5
626107-6023-046	16.00	10.00	50.00	-50.00	M5

## Cubes, CA-M5 (5x)

Cube insert with cone adapter (CA), rotationally adjustable and M5 connecting threads

Connection Type: Cone Adapter  
 Ø Body (DG): 11  
 Material: Titanium

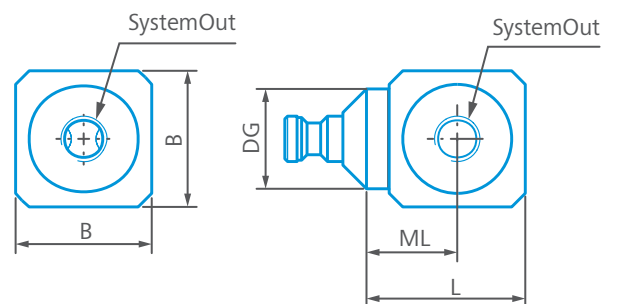

Article-No.	L	ML	B	W1	System out
626107-6280-070	17.50	10.00	15.00	90.00	M5

### Cubes, CA-M3 XXT (5x)

Cube insert with cone adapter (CA), rotationally adjustable and M3 XXT connection threads

Connection Type: Cone Adapter  
 Ø Body (DG): 11  
 Material: Titanium

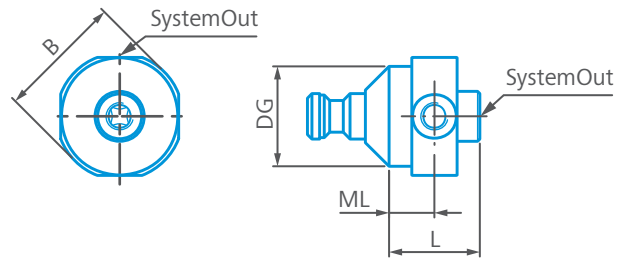

Article-No.	L	ML	W1	System out
626107-6280-060	10.00	5.00	90.00	M3 XXT

### Knuckle joints, CA-M5

Freely adjustable angle insert with cone adapter (CA), rotationally adjustable

Connection Type: Cone Adapter  
 Ø Body (DG): 11  
 Material: Titanium

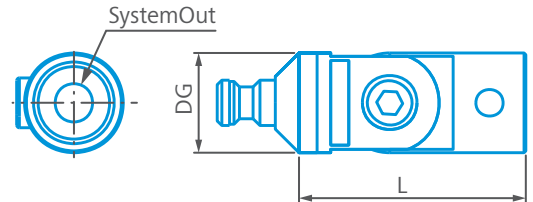

Article-No.	L	System out
626107-6280-040	19.00	M5

### Star elements 4 x 90°, CA-Styli w/o thread

Star insert with cone adapter (CA), rotationally adjustable and 4 x 90° connection options for styli without thread

Connection Type: Cone Adapter  
 Ø Body (DG): 11  
 Material: Titanium

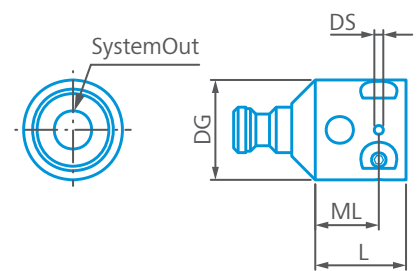

Article-No.	L	ML	DS	W1	System out
626107-6280-050	10.00	7.00	1.00	90.00	M5
626107-6280-110	10.00	7.00	1.50	90.00	M5
626107-6280-120	10.00	7.00	2.00	90.00	M5

## Star elements 6 x 60°, CA-Styli w/o thread

Star insert with cone adapter (CA), rotationally adjustable and 6 x 60° connection options for styli without thread

Connection Type: Cone Adapter  
 Ø Body (DG): 11  
 Material: Titanium

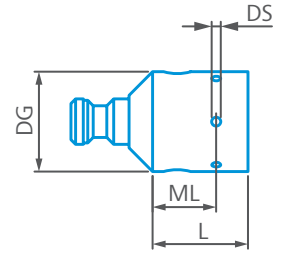

Article-No.	L	ML	DS	W1	System out
626107-6280-130	10.00	7.00	1.00	60.00	Without thread

## Star elements 6 x 60°, CA-M3 XXT

Star insert with cone adapter (CA), rotationally adjustable and 6 x 60° M3 XXT connections

Connection Type: Cone Adapter  
 Ø Body (DG): 11  
 Material: Titanium

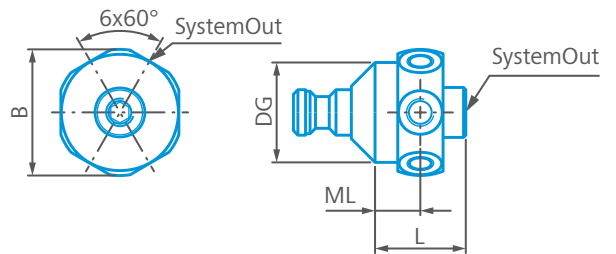

Article-No.	L	ML	B	W1	System out
626107-6280-100	10.00	5.00	14.00	60.00	M3 XXT

## Star elements 3x120°, CA-M5

Star insert with cone adapter (CA), rotationally adjustable and 3 x 120° M5 connections

Connection Type: Cone Adapter  
 Ø Body (DG): 11  
 Material: Titanium

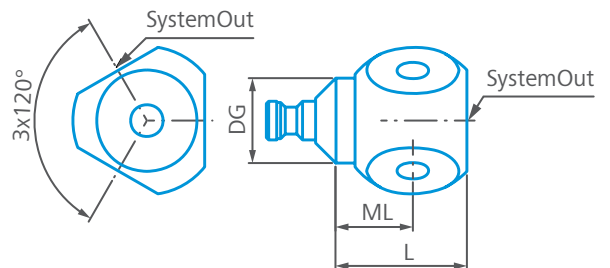

Article-No.	L	ML	B	W1	System out
626107-6280-090	17.50	10.00	15.00	120.00	M5

# Screws

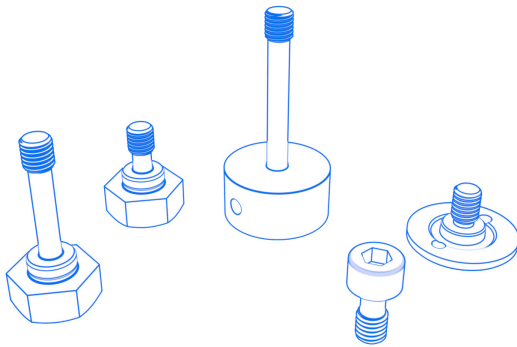

Screws for fastening and adjusting various connecting elements and stylus discs. Undercut screws can be screwed into an extension through the cube. This enables angular adjustment of the following components. The required length of the screw depends on the thickness of the inserted cube.

## Cube screws, M5

Specially undercut screws with threaded connection for clamping components through a cube

Connection Type: M5  
Material: Steel

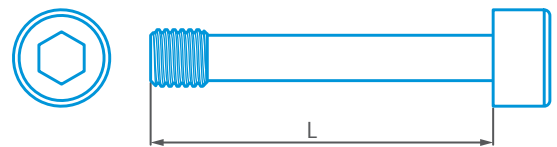

Article-No.	L	ML
626109-0015-000	20.00	15.00
626109-0016-000	25.00	20.00
626109-0017-000	27.00	22.00

## Cube screw with screw-on option, M5-M5

Specially undercut screws with threaded connection for clamping components through a cube

Connection Type: M5  
Ø Body (DG): 11  
Material: Steel

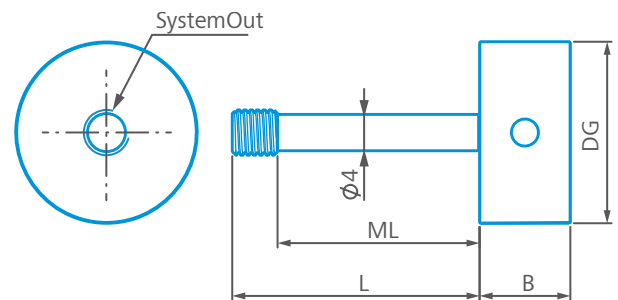

Article-No.	L	ML	B	System out
626109-0023-000	20.00	15.00	15.00	M5
626109-0024-000	25.00	20.00	15.00	M5

## Mounting screw for ceramic disks, M5

Special clamping screw for ceramic touch discs with two-hole system

Connection Type: M5  
 Shaft Material: Steel  
 Material: Steel

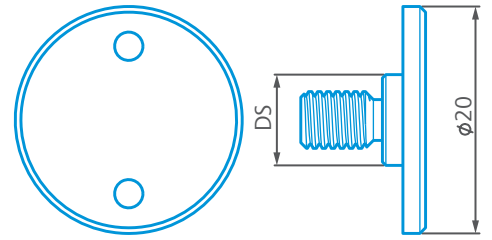

Article-No.	DS
626105-6271-001	8.00
626105-6271-002	16.00

## Fastening screw for stylus disks, M5

Screws for attaching standard touch plates to extensions or special holders.

Connection Type: M5  
 Material: Steel

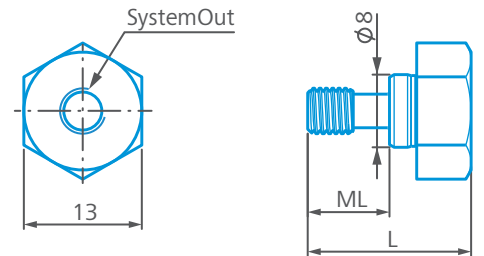

Article-No.	L	ML	System out
600341-0212-000	17.50	10.00	M5
600341-0211-000	30.00	21.00	M5
600341-0210-000	35.00	26.00	M5

## Styli holders

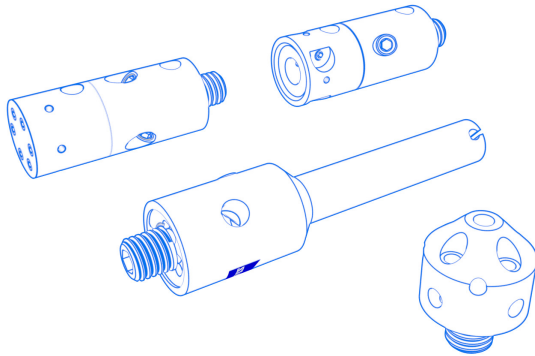

Clamp holders are used when styli without threads comes into action. Even if the stylus breaks off, the holder can be reused. Clamping styli are available in different versions. They are usually used as holders for star styli. However, L styli and adjustable angle styli can also be found in the portfolio.

### 5-way holder for styli without thread, M5 - w/o thread

Stylus holder M5 for styli without thread, arrangement 4 x 90° plus 1 x at the front, clamping from the front

Connection Type: M5  
 Ø Body (DG): 11  
 Material: Steel

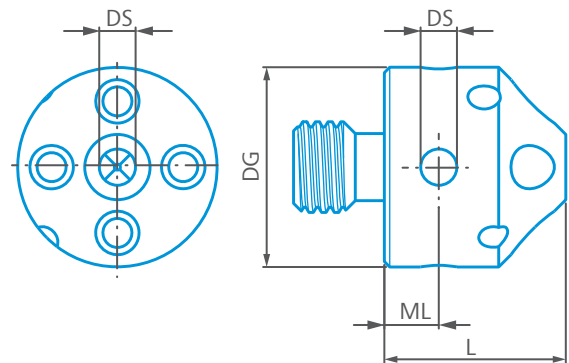

Article-No.	L	ML	DS	System out
600341-8367-000	10.00	3.00	1.00	Without thread
600341-8368-000	10.00	3.00	1.50	Without thread
626115-5000-199	10.00	3.00	2.00	Without thread

### 90° Styli holder, M3 XXT

M5 stylus holder for M3 XXT styli at an angle of 90° to the main axis

Connection Type: M5  
 Ø Body (DG): 11  
 Material: Titanium

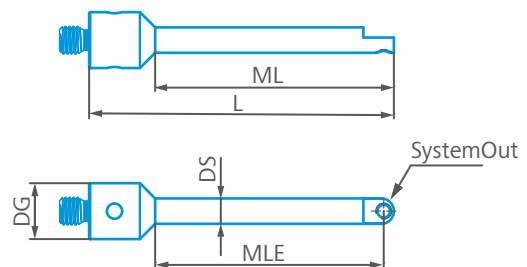

Article-No.	L	ML	DS	MLE	System out
626105-6190-005	33.00	20.00	5.00	18.00	M3
626105-6190-060	60.00	47.00	5.00	45.00	M3



## 90° Holder for styli without thread, M5 - w/o thread

90° holder for styli without thread, from M5 to styli without thread

Connection Type: M5  
 Ø Body (DG): 11  
 Material: Steel

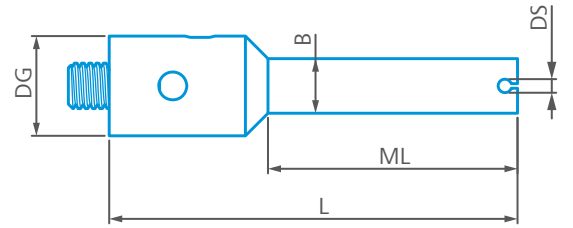

Article-No.	L	ML	DS	B	System out
600341-8160-000	45.00	22.00	1.50	6.00	Without thread

## Holder for swivel stylus 0° to 110°, M5-ball

Holder for rotary switch 0° to 110°, from M5 to special switches with sphere connection

Connection Type: M5  
 Ø Body (DG): 11  
 Material: Steel

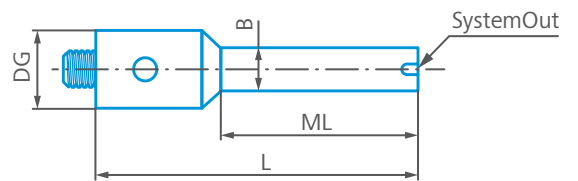

Article-No.	L	ML	B	System out
600341-8180-000	40.00	22.00	6.00	Without thread

# Adapters

Adapters allow you to connect components from different thread systems.

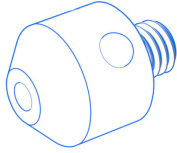

## Thread adapters, M5-X

Thread adapter to extend the screw-on option from M5 to smaller thread sizes.

Connection Type: M5  
 Ø Body (DG): 11  
 Material: Steel

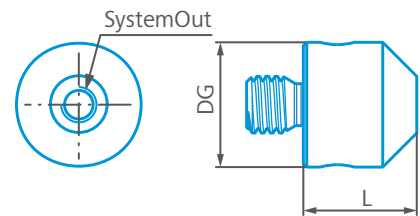

Article-No.	L	System out
602030-0315-000	10.00	M3
602030-0215-000	10.00	M2
602030-0318-000	10.00	M4

# Angles

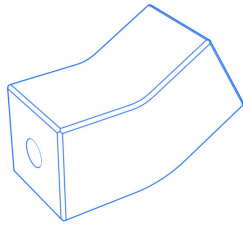

## Single angle pieces, Aluminium, M5-M5

Standard element with fixed milled angle

Connection Type: M5  
Material: Aluminum

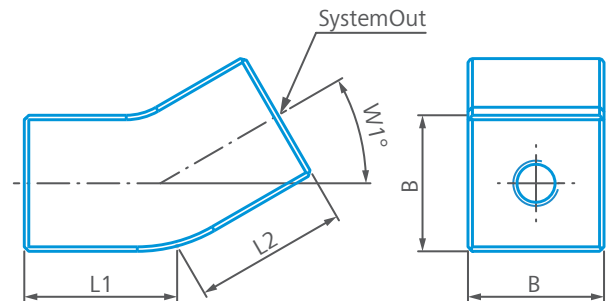

Article-No.	L	B	L1	W1	System out
626105-6020-008	15.00	12.00	15.00	8.00	M5
626105-6020-010	15.00	12.00	15.00	10.00	M5
626105-6020-011	15.00	12.00	15.00	11.00	M5
626105-6020-012	15.00	12.00	15.00	12.00	M5
626105-6020-014	15.00	12.00	15.00	14.00	M5
626105-6020-015	15.00	12.00	15.00	15.00	M5
626105-6020-016	15.00	12.00	15.00	16.00	M5
626105-6020-020	15.00	12.00	15.00	20.00	M5
626105-6020-025	15.00	12.00	15.00	25.00	M5
626105-6020-027	15.00	12.00	15.00	27.00	M5
626105-6020-030	15.00	12.00	15.00	30.00	M5
626105-6020-033	15.00	12.00	15.00	33.00	M5
626105-6020-035	15.00	12.00	15.00	35.00	M5
626105-6020-040	15.00	12.00	15.00	40.00	M5
626105-6020-045	15.00	12.00	15.00	45.00	M5
626105-6020-050	15.00	12.00	15.00	50.00	M5
626105-6020-055	15.00	12.00	15.00	55.00	M5
626105-6020-060	15.00	12.00	15.00	60.00	M5
626105-6020-065	15.00	12.00	15.00	65.00	M5
626105-6020-070	15.00	12.00	15.00	70.00	M5
626105-6020-074	15.00	12.00	15.00	74.00	M5
626105-6020-075	15.00	12.00	15.00	75.00	M5
626105-6020-076	15.00	12.00	15.00	76.00	M5
626105-6020-080	15.00	12.00	15.00	80.00	M5
626105-6020-090	15.00	12.00	15.00	90.00	M5

# Counterweights

Counterweights for balancing stylus systems

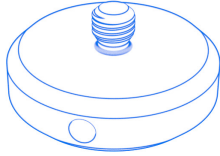

## Counterweight, stainless steel, M5

Counterweight to compensate for tilting moments in single-sided stylus systems

Connection Type: M5  
 Ø Body (DG): 25  
 Material: Steel

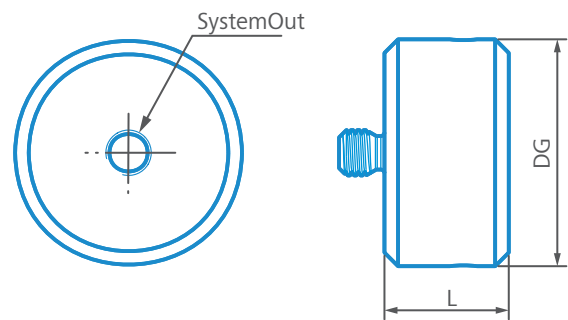

Article-No.	L	Weight	System out
626105-6270-004	13.69	50.00	M5
626105-6270-005	19.90	75.00	M5
626105-6270-003	26.60	100.00	M5
626105-6270-006	39.30	150.00	M5
626105-6270-007	52.20	200.00	M5

# Cubes

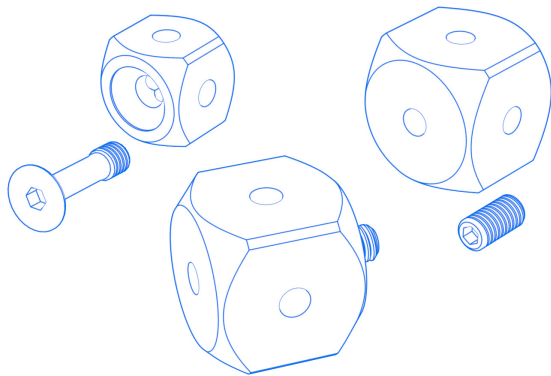

Cubes are the most common connection element in a stylus system.

## Cubes, aluminium, M5-M5 (5x)

Standard cubes are the simplest connecting element for branching and star T or L elements

Connection Type: M5  
Material: Aluminium

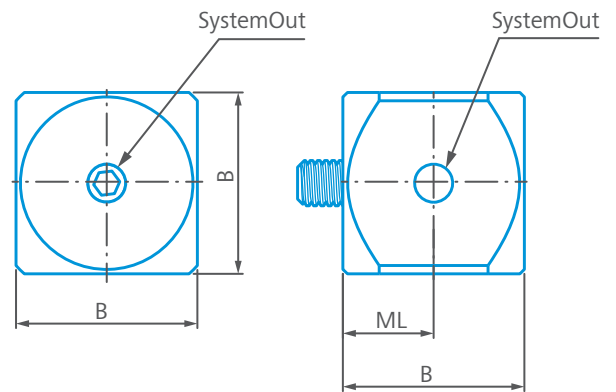

Article-No.	L	ML	B	W1	System out
602030-8363-000	15.00	7.50	15.00	90.00	M5
602030-8362-000	20.00	10.00	20.00	90.00	M5

## Cubes, titanium, M5-M5 (5x)

Standard cubes are the simplest connecting element for branching and star T or L elements

Connection Type: M5  
Material: Titanium

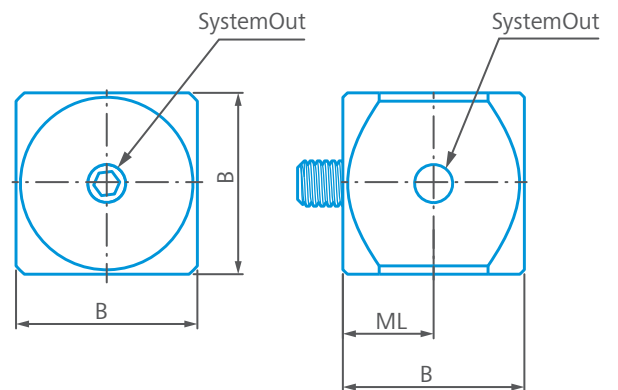

Article-No.	L	ML	B	W1	System out
600341-8361-000	15.00	7.50	15.00	90.00	M5
626115-6110-001	15.00	7.50	15.00	90.00	M5



Article-No.	L	ML	B	W1	System out
600341-8002-000	20.00	10.00	20.00	90.00	M5
626115-6110-003	20.00	10.00	20.00	90.00	M5

### Cube with cone and countersink, titanium, M5-M5 (4x)

Standard cubes are the simplest connecting element for branching and star T or L elements

Connection Type: M5  
Material: Titanium

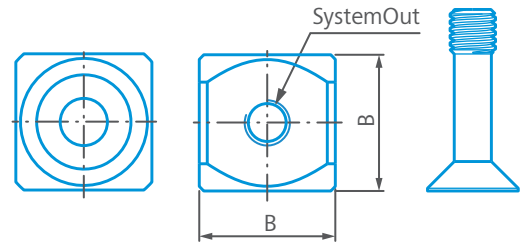

Article-No.	L	B	W1	System out
626115-6110-002	15.00	15.00	90.00	M5

# Multi sided cubes

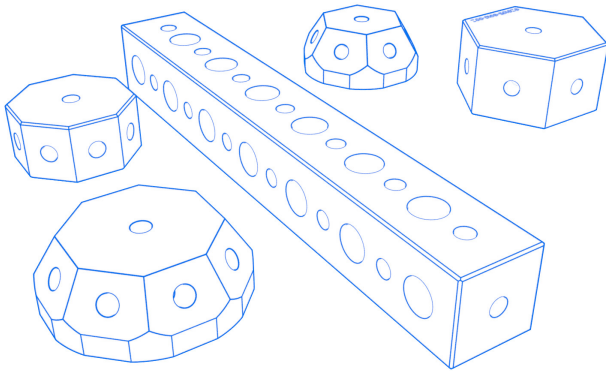

## Multiple horizontal angle piece, 8x45°, M5

8-fold angle piece with 45° pitch. Screw-on surface at right angles to the main axis

Consisting of:  
Multiple angle piece made of titanium

Connection Type: M5  
Ø Body (DG): 29  
Material: Titanium

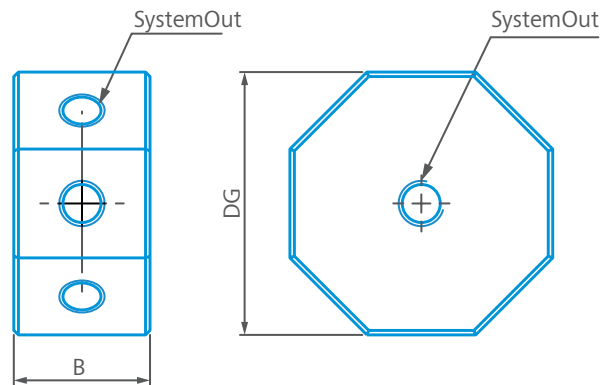

Article-No.	B	W1	System out
626105-6110-000	15.00	45.00	M5

## Multiple horizontal angle piece, 5x72°, M5

5-fold angle piece with 72° pitch. Screw-on surface at right angles to the main axis

Consisting of:  
Multiple angle piece made of titanium

Connection Type: M5  
Ø Body (DG): 32  
Material: Titanium

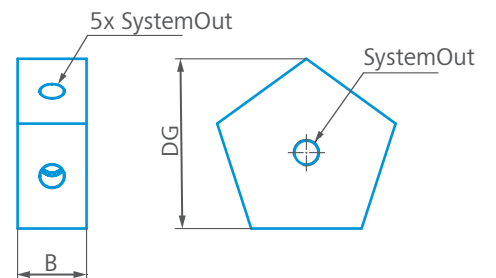

Article-No.	B	W1	System out
626105-6110-005	13.00	72.00	M5

### Angled multiple angle piece, 8x45°, M5

8-fold angle piece with 45° pitch. Screw-on surface inclined 30° to the main axis

Consisting of:  
Multiple angle piece made of titanium

Connection Type: M5  
Ø Body (DG): 41  
Material: Titanium

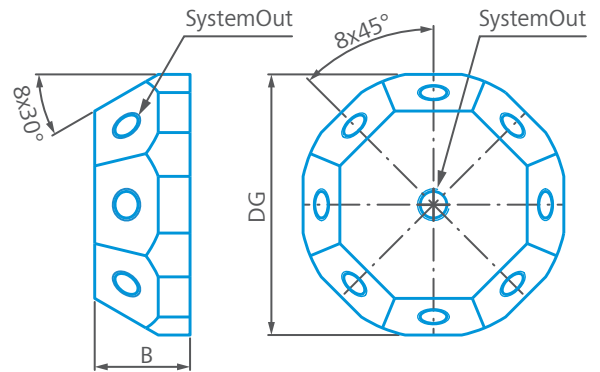

Article-No.	B	W1	System out
626105-6110-030	15.00	30.00	M5
626105-6110-033	15.00	45.00	M5

### Angled multiple angle piece, 6x60°, M5

6-fold angle piece with 60° pitch. Screw-on surface inclined 30° to the main axis

Consisting of:  
Multiple angle piece made of titanium

Connection Type: M5  
Ø Body (DG): 34  
Material: Titanium

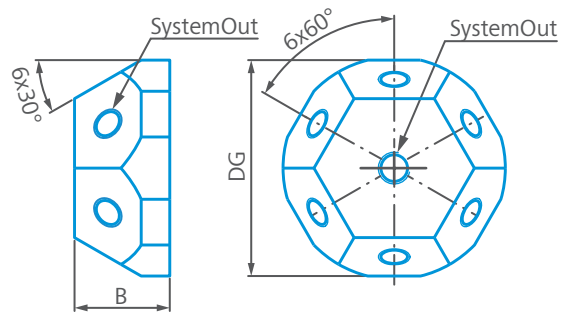

Article-No.	B	W1	System out
626105-6110-031	15.00	30.00	M5





## M5 Pro

M5 Pro is a patented modular system for expanding the standard M5 portfolio

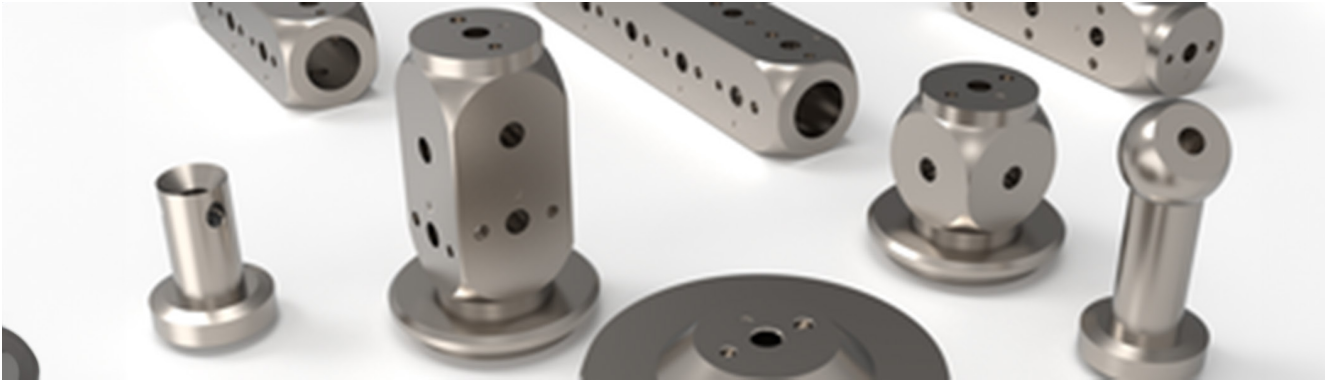

In addition to the standard M5 portfolio, ZEISS offers the patented M5 pro technology. The difference between the M5 pro system and the conventional M5 connection points is that the connecting elements of the M5 pro system are joined via 2 dowel pins and are therefore positioned in an exact orientation. Instead of a threaded pin and rotational screwing in, the M5 pro elements are inserted and fixed from the opposite side with an additional screw.



### M5 pro system with rotating elements

In conjunction with the rotationally adjustable connecting elements, the M5 pro system is unique. The rotationally adjustable elements can be easily set to any desired angle of rotation via the conical connection. The 3 fastening screws can then be used to secure the rotary element against rotation with little effort. A unique connection point within the cone holder allows this process to be repeated many times without damaging the swivel joint. Fixed angles can then be changed easily and with repeat accuracy via the M5 per pin connection without having to readjust the angle each time. This means that different stylus systems with only one different angle can often be dispensed with.

### Reliable series measurement

The pinned connections of the M5 pro system create a torsion-proof unit within the push-button system. Each screw connection is ultimately a force-fit clamp connection that can be adjusted depending on the force required. Force-fit connections also loosen over time due to material relaxation. It can therefore happen that the set angle in the stylus system is adjusted without the user really being aware of it. This can result in incorrect measurements due to shaft contact, which can only be avoided by regularly checking all angles. The pinned connection of the M5 pro elements creates a one-piece, torsion-proof unit. This means that even collisions cannot change the set angle. This means that series measurements can be carried out reliably without time-consuming checks.



## Knuckle and rotary elements

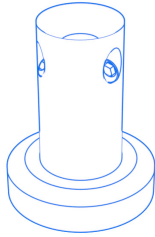

### Rotary joints Basic, M5 pro - CR

Basic swivel elements consist of the actual M5 per basic element with M5 thread with dowel pins and a cone adapter on the opposite side.

Consisting of:  
 Titanium base rotary unit with M5 thread and dowel pins and opposite cone holder for rotating elements  
 3 M3 clamping screws

Connection Type: M5 Pro  
 Ø Body (DG): 11  
 Material: Titanium

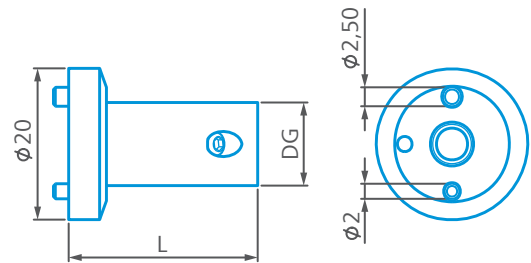

Article-No.	L	System out
626107-6060-000	25.00	Cone Receiver

# Screws

Screws for fixing a wide range of connection elements and stylus disks.

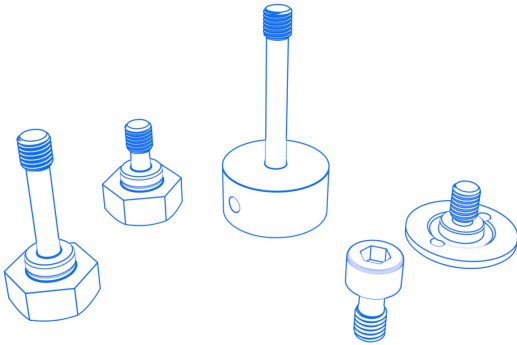

## Cube screw, M5 pro

Specially undercut screws with threaded connection for clamping components through a cube

Connection Type: M5 Pro  
Material: Steel

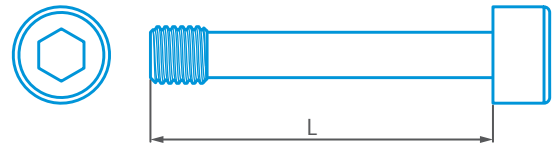

Article-No.	L	ML
626107-6060-001	15.00	10.00
626107-6060-002	30.00	25.00

## Cube screw with screw-on option, M5 pro

Specially undercut screws with threaded connection for clamping components through a cube

Connection Type: M5 Pro  
Material: Steel

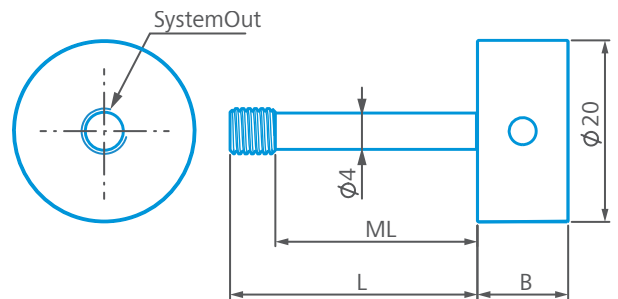

Article-No.	L	ML	B	System out
626107-6060-006	30.00	25.00	10.00	M5

# Adapters

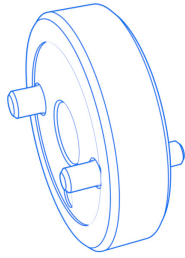

## Connection adapter, M5 pro - M5 pro

Connection plate with index pins on both sides for M5 pro element

Consisting of:  
 Adapter piece  $\varnothing 20$  mm made of titanium  
 2 Index pins on both sides

Connection Type: M5 Pro  
 $\varnothing$  Body (DG): 20  
 Material: Titanium

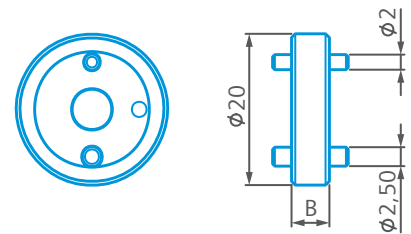

Article-No.	B	System out
626107-6060-004	5.00	M5 Pro

# Angles

Angle pieces for building angled stylus combinations.

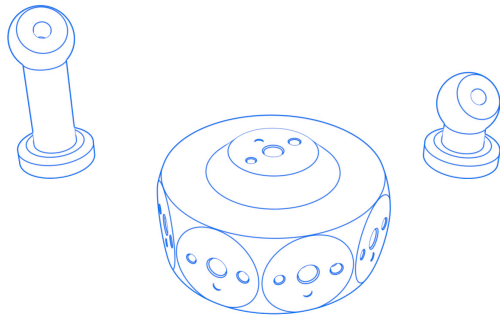

## Single spatial angle piece, M5 pro - M5

Titanium angle element with milled spatial angle W1 and W2. With M5 pro adaptation consisting of M5 thread and 2 index pins

Consisting of:  
Single angle piece made of titanium

Connection Type: M5 Pro  
Ø Body (DG): 20  
Material: Titanium

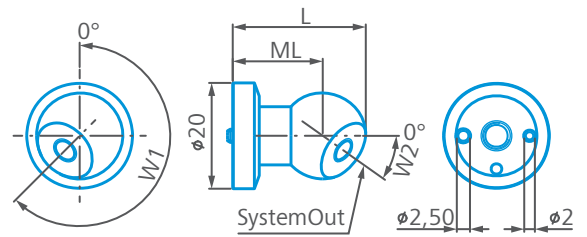

Article-No.	L	ML	W1	W2	System out
626107-6021-086	25.00	17.00	0.00	12.00	M5
626107-6021-319	25.00	17.00	180.00	11.70	M5
626107-6021-048	25.00	17.00	270.00	7.00	M5
626107-6021-406	25.00	17.00	90.00	26.00	M5
626107-6021-054	25.00	17.00	270.00	90.00	M5
626107-6021-750	25.00	17.00	170.00	90.00	M5
626107-6021-491	25.00	17.00	180.00	11.20	M5
626107-6021-192	25.00	17.00	270.00	10.00	M5
626107-6021-198	25.00	17.00	270.00	15.00	M5
626107-6021-679	25.00	17.00	270.00	25.00	M5
626107-6021-626	25.00	17.00	270.00	25.50	M5
626107-6021-029	25.00	17.00	0.00	23.00	M5
626107-6021-232	25.00	17.00	90.00	30.00	M5
626107-6021-665	25.00	17.00	186.60	100.00	M5
626107-6021-735	25.00	17.00	115.40	53.70	M5
626107-6021-046	25.00	17.00	90.00	10.00	M5
626107-6021-315	25.00	17.00	90.00	45.00	M5
626107-6021-361	25.00	17.00	0.00	17.00	M5
626107-6021-381	25.00	17.00	180.00	82.00	M5
626107-6021-433	25.00	17.00	180.00	17.00	M5
626107-6021-636	25.00	17.00	180.00	14.90	M5
626107-6021-637	25.00	17.00	0.00	14.90	M5
626107-6021-641	25.00	17.00	90.00	71.70	M5
626107-6021-642	25.00	17.00	180.00	6.30	M5



Article-No.	L	ML	W1	W2	System out
626107-6021-518	25.00	17.00	90.00	25.00	M5
626107-6021-680	25.00	17.00	227.00	8.00	M5
626107-6021-664	25.00	17.00	177.70	80.40	M5
626107-6021-498	25.00	17.00	0.00	0.00	M5
626107-6021-544	25.00	17.00	129.70	37.80	M5
626107-6021-545	25.00	17.00	116.30	61.90	M5
626107-6021-546	25.00	17.00	50.30	37.80	M5
626107-6021-614	25.00	17.00	0.00	9.00	M5
626107-6021-684	25.00	17.00	45.00	45.00	M5
626107-6021-686	25.00	17.00	135.00	45.00	M5
626107-6021-690	25.00	17.00	125.30	60.00	M5
626107-6021-007	25.00	17.00	0.00	11.00	M5
626107-6021-036	25.00	17.00	20.00	6.50	M5
626107-6021-120	25.00	17.00	180.00	20.00	M5
626107-6021-055	25.00	17.00	270.00	45.00	M5
626107-6021-064	25.00	17.00	0.00	20.00	M5
626107-6021-074	25.00	17.00	0.00	10.00	M5
626107-6021-162	25.00	17.00	0.00	5.00	M5
626107-6021-179	25.00	17.00	90.00	15.00	M5
626107-6021-004	25.00	17.00	170.70	12.10	M5
626107-6021-216	25.00	17.00	0.00	24.00	M5
626107-6021-316	25.00	17.00	180.00	12.00	M5
626107-6021-338	25.00	17.00	180.00	6.80	M5
626107-6021-585	25.00	17.00	90.00	3.00	M5
626107-6021-609	25.00	17.00	270.00	12.50	M5
626107-6021-611	25.00	17.00	168.40	47.40	M5
626107-6021-628	25.00	17.00	180.00	2.40	M5
626107-6021-673	25.00	17.00	180.00	52.00	M5
626107-6021-728	25.00	17.00	241.90	3.10	M5
626107-6021-729	25.00	17.00	131.60	3.00	M5
626107-6021-730	25.00	17.00	9.30	12.10	M5
626107-6021-731	25.00	17.00	197.30	12.60	M5
626107-6021-732	25.00	17.00	342.70	12.60	M5
626107-6021-733	25.00	17.00	21.50	5.90	M5
626107-6021-734	25.00	17.00	330.30	6.30	M5
626107-6021-736	25.00	17.00	171.60	12.00	M5
626107-6021-737	25.00	17.00	15.60	29.80	M5
626107-6021-738	25.00	17.00	196.50	12.50	M5
626107-6021-754	25.00	17.00	282.60	9.20	M5
626107-6021-755	25.00	17.00	83.20	17.10	M5
626107-6021-756	25.00	17.00	323.50	44.10	M5
626107-6021-757	25.00	17.00	156.70	23.00	M5
626107-6021-760	25.00	17.00	325.80	20.70	M5
626107-6021-761	25.00	17.00	276.80	17.10	M5
626107-6021-762	25.00	17.00	257.40	9.20	M5
626107-6021-763	25.00	17.00	40.00	7.00	M5
626107-6021-764	25.00	17.00	217.00	90.00	M5
626107-6021-765	25.00	17.00	335.00	15.00	M5
626107-6021-630	25.00	17.00	180.00	37.50	M5
626107-6021-050	25.00	17.00	270.00	35.00	M5
626107-6021-112	25.00	17.00	180.00	45.00	M5



Article-No.	L	ML	W1	W2	System out
626107-6021-212	25.00	17.00	0.00	15.00	M5
626107-6021-355	25.00	17.00	180.00	90.00	M5
626107-6021-617	25.00	17.00	0.00	55.00	M5
626107-6022-045	43.00	35.00	0.00	45.00	M5
626107-6022-365	43.00	35.00	0.00	8.00	M5
626107-6022-252	43.00	35.00	180.00	8.00	M5
626107-6022-801	43.00	35.00	229.60	37.60	M5
626107-6022-419	43.00	35.00	0.00	5.00	M5
626107-6022-800	43.00	35.00	319.60	37.60	M5
626107-6022-843	43.00	35.00	270.00	95.50	M5
626107-6022-697	43.00	35.00	270.00	25.50	M5
626107-6022-166	43.00	35.00	180.00	20.00	M5
626107-6022-713	43.00	35.00	180.00	6.30	M5
626107-6022-164	43.00	35.00	270.00	45.00	M5
626107-6022-726	43.00	35.00	183.20	100.00	M5
626107-6022-103	43.00	35.00	180.00	50.00	M5
626107-6022-592	43.00	35.00	180.00	15.60	M5
626107-6022-708	43.00	35.00	0.00	6.30	M5
626107-6022-821	43.00	35.00	192.00	90.00	M5
626107-6022-822	43.00	35.00	101.30	83.60	M5
626107-6022-162	43.00	35.00	90.00	45.00	M5
626107-6022-703	43.00	35.00	338.00	16.00	M5
626107-6022-704	43.00	35.00	180.00	14.00	M5
626107-6022-201	43.00	35.00	0.00	10.00	M5
626107-6022-579	43.00	35.00	90.00	24.00	M5
626107-6022-580	43.00	35.00	90.00	4.00	M5
626107-6022-750	43.00	35.00	309.70	37.80	M5
626107-6022-835	43.00	35.00	180.00	17.00	M5
626107-6022-817	43.00	35.00	0.00	23.00	M5
626107-6022-816	43.00	35.00	114.30	38.40	M5
626107-6022-024	43.00	35.00	270.00	60.30	M5
626107-6022-030	43.00	35.00	0.00	30.00	M5
626107-6022-147	43.00	35.00	180.00	35.00	M5
626107-6022-232	43.00	35.00	180.00	5.00	M5
626107-6022-279	43.00	35.00	0.00	0.00	M5
626107-6022-329	43.00	35.00	270.00	90.00	M5
626107-6022-625	43.00	35.00	0.00	17.00	M5
626107-6022-792	43.00	35.00	49.60	37.60	M5
626107-6022-795	43.00	35.00	180.00	37.00	M5
626107-6022-832	43.00	35.00	180.00	20.50	M5
626107-6022-833	43.00	35.00	0.00	20.50	M5
626107-6022-836	43.00	35.00	39.90	37.50	M5
626107-6022-837	43.00	35.00	114.50	16.50	M5
626107-6022-838	43.00	35.00	46.00	20.40	M5
626107-6022-839	43.00	35.00	221.20	22.90	M5
626107-6022-840	43.00	35.00	303.00	34.50	M5
626107-6022-841	43.00	35.00	27.90	16.50	M5
626107-6022-844	43.00	35.00	320.60	19.10	M5
626107-6022-845	43.00	35.00	72.00	42.40	M5
626107-6022-846	43.00	35.00	224.60	14.10	M5
626107-6022-847	43.00	35.00	27.50	17.00	M5
626107-6022-848	43.00	35.00	0.00	37.00	M5
626107-6022-849	43.00	35.00	315.00	46.70	M5
626107-6022-850	43.00	35.00	134.90	46.70	M5



Article-No.	L	ML	W1	W2	System out
626107-6022-851	43.00	35.00	180.00	32.50	M5
626107-6022-852	43.00	35.00	135.00	19.00	M5
626107-6022-861	43.00	35.00	50.60	19.10	M5
626107-6022-169	43.00	35.00	0.00	20.00	M5
626107-6022-007	43.00	35.00	180.00	60.00	M5
626107-6022-026	43.00	35.00	180.00	45.00	M5
626107-6022-141	43.00	35.00	90.00	30.00	M5
626107-6022-216	43.00	35.00	180.00	15.00	M5
626107-6022-356	43.00	35.00	270.00	15.00	M5

### Multiple angle piece 8x45°, M5 pro

8-fold angle piece with 45° pitch. Mounting surface at right angles to the main axis. With M5 pro connection options with M5 thread and index holes

Consisting of:  
Multiple angle piece made of titanium

Connection Type: M5 Pro  
Ø Body (DG): 20  
Material: Titanium

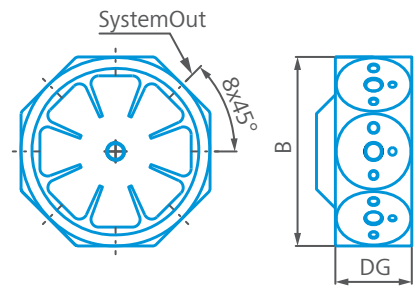

Article-No.	B	W1	System out
626107-6060-009	50.00	45.00	M5



# Multiple holders

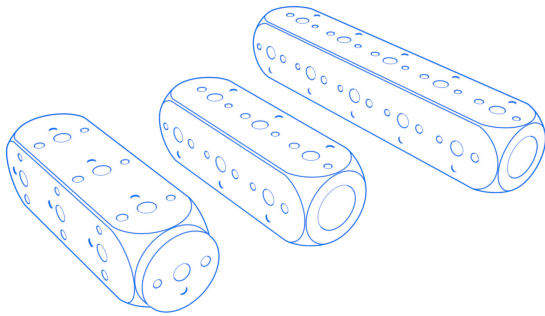

Multiple holders are milled styli holders that are available in different designs. From beams to complex angular elements, almost any shape can be realized. Due to the high complexity of the requirements, the standard portfolio in the M5 range is limited to the most common shapes. Greater flexibility can be achieved by using M5 pro elements.

## Multiple styli bar 3-fold, M5 pro

3-fold holder in strip design 20 x 20 mm in different lengths. Several M5 screw-on options for styli or extensions

Consisting of:  
Multi-bar 20x20 mm made of titanium

Connection Type: M5 Pro  
Material: Titanium

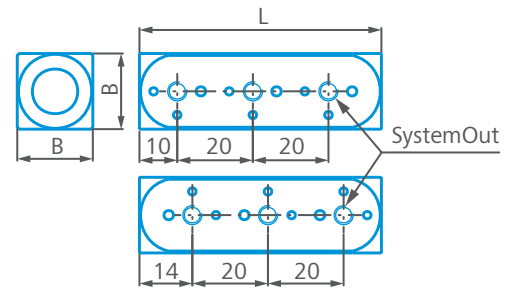

Article-No.	L	B	System out
626107-6060-003	64.00	20.00	M5 Pro

## Multiple styli bar 3-fold with side connection, M5 pro

Triple holder in strip design 20 x 20 mm. Several M5 screw-on options for styli or extensions, also with M5 pro connections on the front side

Consisting of:  
Multi-bar 20x20 mm made of titanium

Connection Type: M5 Pro  
Material: Titanium

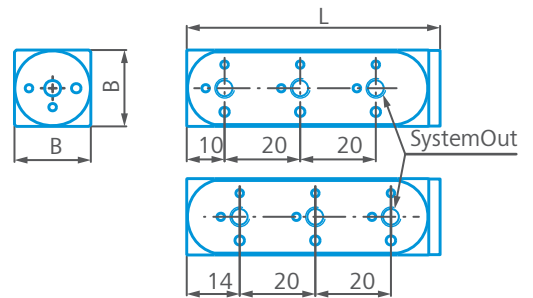

Article-No.	L	B	System out
626107-6060-007	67.00	20.00	M5 Pro

### Multiple styli bar 5-fold, M5 pro

Multiple holder in bar design 20 x 20 mm with 5-way connection. Several M5 screw-on options for styli or extensions

Consisting of:  
5-way bar 20x20 mm made of titanium

Connection Type: M5 Pro  
Material: Titanium

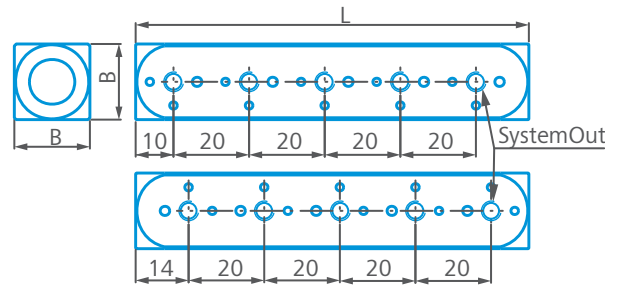

Article-No.	L	B	System out
626107-6060-005	104.00	20.00	M5 Pro

## M3 XXT

M3 XXT connecting elements for connecting extensions or styli in a stylus system for use on VAST XXT probes



There are two basic types of connection elements in the M3 XXT system. Clampable elements are attached using clamping screws, clamping extensions or clamping styli and can also be rotationally adjusted in this way. Rotatable elements made of titanium are the new generation in the M3 XXT portfolio. They are based on the same principle as the elements from the M5 system. The different connecting elements are adjusted and fixed using a free tapered cone connection. Three robust M1.2 grub screws ensure high clamping forces with low screwing forces.

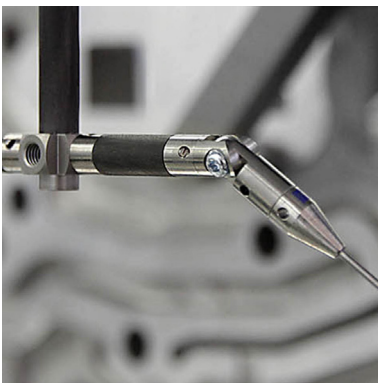

### M3 XXT rotating elements of the second generation

The rotatable M3 XXT elements of the second generation differ fundamentally from the conventional systems with clamping screws. Thanks to a coordinated fit ratio and the tapered design, this system enables stable fixing of the elements with low tightening torques for the clamping screws. Another advantage over the elements of the first generation. All connected parts remain in one axis, whereas conventional connecting elements generate an offset due to the connection point, which can lead to a more complex programming effort due to limited accessibility. The weight of the second generation connecting elements is also significantly lighter than that of generation 1.

### Weight limitation on VAST XXT measuring heads

Due to the sensitivity of the VAST XXT probes, the usable weights are strictly limited on all variants. When setting up stylus systems, it is therefore important to ensure that the number of elements is not too large and that the weight of the individual elements is not too high. M3 XXT connecting elements are largely made of a titanium alloy. This in itself is significantly lighter than comparable steel alloys. However, the weight is still relatively high, so care must be taken to use the correct items. The stylus systems should also not be too complex, i.e. the number of connections should be reduced to a minimum.



## Knuckle and rotary elements

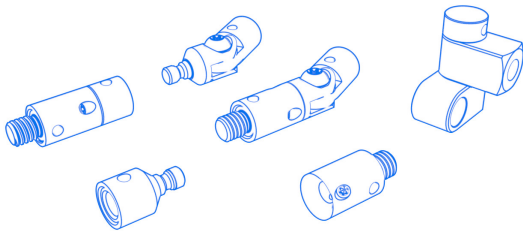

### Rotary joints basic, M3 XXT - CR

Basic swivel elements consist of the actual basic element  $\varnothing 5$  mm with M3 thread and a cone adapter on the opposite side.

Connection Type: M3 XXT  
 $\varnothing$  Body (DG): 5  
 Material: Titanium

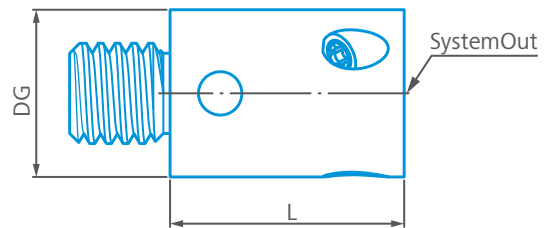

Article-No.	L	System out
626103-6180-002	7.00	Cone Adapter

### Rotary joint Gen. 2 complete, M3 XXT

Complete rotary elements consist of the base element  $\varnothing 5$  mm with M3 grub screw and an already connected rotary adapter with M3 thread

Connection Type: M3 XXT  
 $\varnothing$  Body (DG): 5  
 Material: Titanium

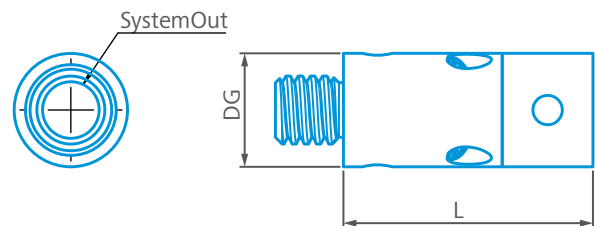

Article-No.	L	System out
626103-6180-010	11.00	M3 XXT

## Rotary-knuckle joints Gen. 2 complete, M3 XXT

Rotary knuckle elements consist of a basic rotary element  $\varnothing 5$  mm with M3 grub screw and an already connected rotary bending element with M3 thread.

Connection Type: M3 XXT

$\varnothing$  Body (DG): 5

Material: Titanium

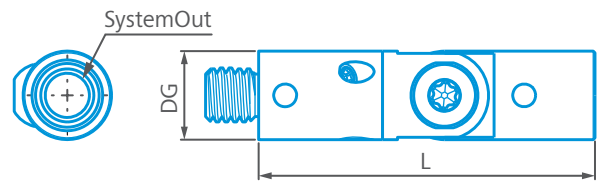

Article-No.	L	System out
626103-6180-020	19.00	M3 XXT

## Rotary-knuckle joints Gen. 1 complete, M3 XXT

The first generation of rotary knuckle elements are characterized by their simplicity. The different angular positions result from the rotation around the clamping screw

Connection Type: M3 XXT

Material: Titanium

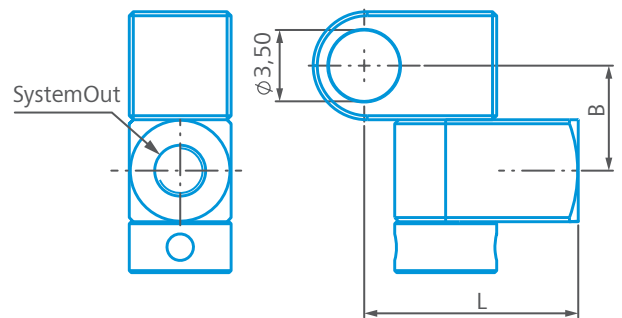

Article-No.	L	B	System out
626103-6180-001	10.00	5.00	M3 XXT

## Inserts with cone adapter

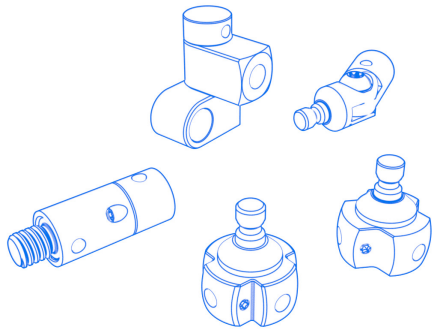

### Rotary joints, CA-M3 XXT

Insert with cone adapter (CA) with M3 XXT connection for setting rotational angles

Connection Type: M3 XXT  
 Ø Body (DG): 5  
 Material: Titanium

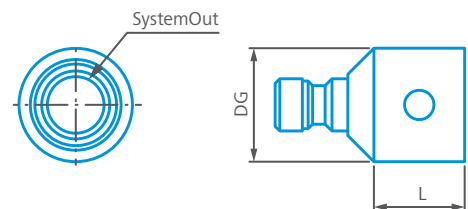

Article-No.	L	System out
626103-6180-011	4.00	M3 XXT

### Single angle pieces Gen. 2, CA-M3 XXT

Angle inserts with cone adapter (CA) and fixed milled angle, rotationally adjustable, with M3 XXT connection

Connection Type: Cone Adapter  
 Ø Body (DG): 5  
 Material: Titanium

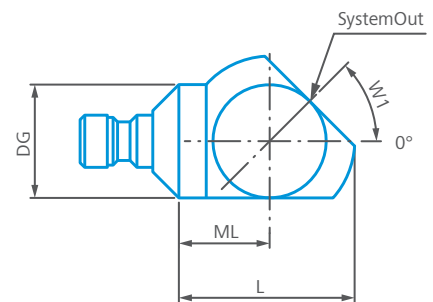

Article-No.	L	ML	W1	System out
626103-6020-005	7.75	4.00	5.00	M3 XXT
626103-6020-007	7.75	4.00	7.00	M3 XXT
626103-6020-010	7.75	4.00	10.00	M3 XXT
626103-6020-015	7.75	4.00	15.00	M3 XXT
626103-6020-020	7.75	4.00	20.00	M3 XXT
626103-6020-025	7.75	4.00	25.00	M3 XXT
626103-6020-030	7.75	4.00	30.00	M3 XXT
626103-6020-035	7.75	4.00	35.00	M3 XXT
626103-6020-040	7.75	4.00	40.00	M3 XXT
626103-6020-045	7.75	4.00	45.00	M3 XXT



Article-No.	L	ML	W1	System out
626103-6020-050	7.75	4.00	50.00	M3 XXT
626103-6020-111	7.75	4.00	52.50	M3 XXT
626103-6020-055	7.75	4.00	55.00	M3 XXT
626103-6020-119	7.75	4.00	55.90	M3 XXT
626103-6020-060	7.75	4.00	60.00	M3 XXT
626103-6020-069	7.75	4.00	69.00	M3 XXT
626103-6020-070	7.75	4.00	70.00	M3 XXT
626103-6020-075	7.75	4.00	75.00	M3 XXT
626103-6020-080	7.75	4.00	80.00	M3 XXT
626103-6020-083	7.75	4.00	83.00	M3 XXT
626103-6020-084	7.75	4.00	84.00	M3 XXT
626103-6020-085	7.75	4.00	85.00	M3 XXT
626103-6020-090	7.75	4.00	90.00	M3 XXT

### Knuckle joint Gen. 2, CA-M3 XXT

Freely adjustable angle insert with cone adapter (CA), rotationally adjustable, with M3 XXT connection

Connection Type: M3 XXT  
 Ø Body (DG): 5  
 Material: Titanium

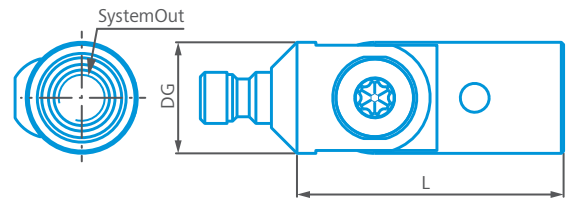

Article-No.	L	System out
626103-6180-021	12.00	M3 XXT

### Star element 3 x 120°, CR-M3 XXT

Star insert with cone adapter (CA), rotationally adjustable and 3 x 120° connection options M3 XXT

Connection Type: M3 XXT  
 Ø Body (DG): 5  
 Material: Titanium

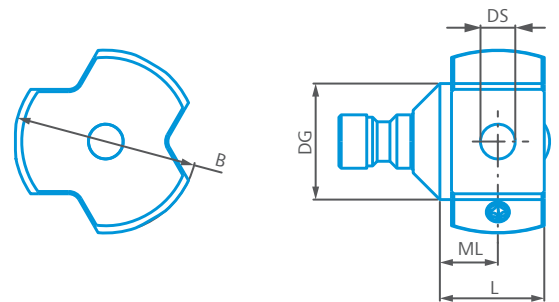

Article-No.	L	ML	DS	B	W1
626103-6180-003	4.70	2.50	1.50	7.90	90.00

### Star element 4 x 90°, CR-M3 XXT

Star insert with cone adapter (CA), rotationally adjustable and 4 x 90° connection options M3 XXT

Connection Type: M3 XXT  
 Ø Body (DG): 5  
 Material: Titanium

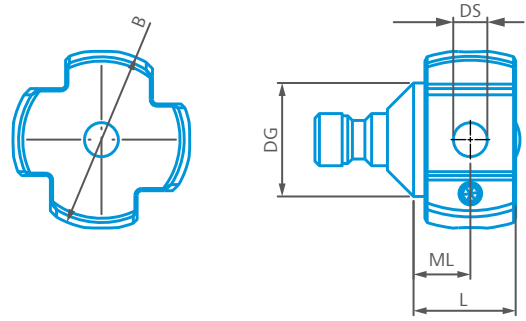

Article-No.	L	ML	DS	B	W1
626103-6180-004	4.70	2.50	1.50	7.90	120.00



# Screws

Screws for fixing a wide range of connection elements and stylus disks.

## Screw for knuckle joint Gen. 1, M3 XXT

Replacement screw for M3 XXT knuckle element Gen. 1, lateral clamping screw

Connection Type: M3 XXT  
 Ø Body (DG): 3.5  
 Material: Titanium

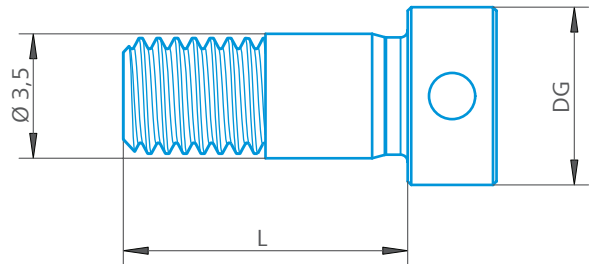

Article-No.	L
626103-6110-004	8.00

## Screw with female thread for knuckle joint Gen. 1, M3 XXT

Replacement screw for M3 XXT knuckle element Gen. 1, lateral clamping screw

Connection Type: M3 XXT  
 Ø Body (DG): 4  
 Material: Titanium

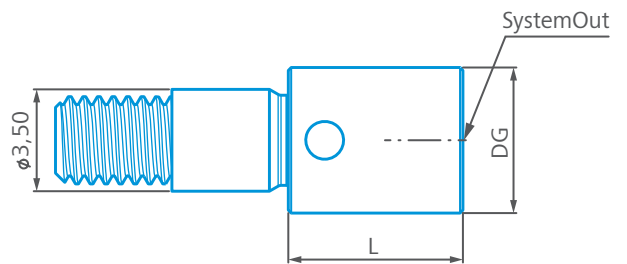

Article-No.	L	System out
626103-6110-005	8.00	M3 XXT

# Adapters

Adapters allow you to connect components from different thread systems

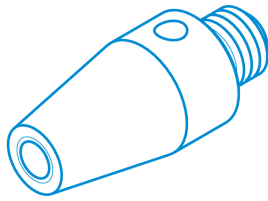

## Thread reductions, M3 XXT - X

Thread adapter to extend the screw-on option from M3 XXT (Ø5 mm) to smaller thread sizes.

Connection Type: M3 XXT  
 Ø Body (DG): 5  
 Material: Titanium

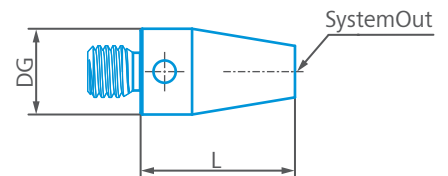

Article-No.	L	System out
626170-0002-715	9.00	M2

# Counterweight



Counterweights for balancing stylus systems.



## Counterweight, stainless steel, M3 XXT

Counterweight to compensate for tilting moments in single-sided stylus systems

Connection Type: M3 XXT  
Ø Body (DG): 7  
Material: Steel

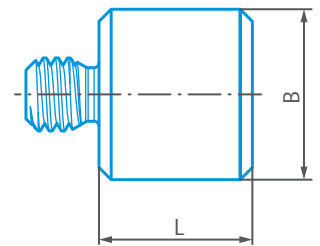

Article-No.	L	Weight
626103-6270-000	6.30	2.00
626103-6270-001	9.60	3.00

## Cubes and various elements for clamping

Cubes are the most common connection element in a stylus system.

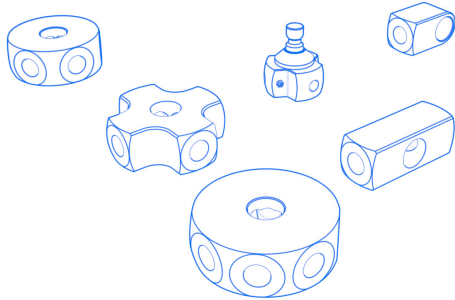

### Cube 1 x 360°, M3 XXT

One sided cube with an M3 XXT connection and fitting hole, rotationally adjustable and clampable using a clamping screw

Connection Type: M3 XXT  
Material: Titanium

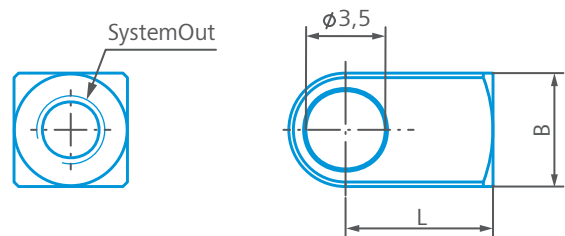

Article-No.	L	B	W1	System out
626103-6110-001	6.50	5.00	90.00	M3 XXT

### Cube 2 x 180°, M3 XXT

Double angle piece with two opposing M3 XXT connections and fitting hole, rotationally adjustable and clampable using a clamping screw

Connection Type: M3 XXT  
Material: Titanium

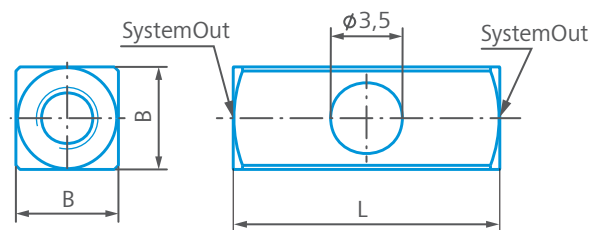

Article-No.	L	B	W1	System out
626103-6110-002	13.00	5.00	180.00	M3 XXT

## Cube 4 x 90°, M3 XXT

Cross angle piece with 4 M3 XXT connections at a 90° angle and fitting hole, rotationally adjustable and clampable using a clamping screw

Connection Type: M3 XXT  
Material: Titanium

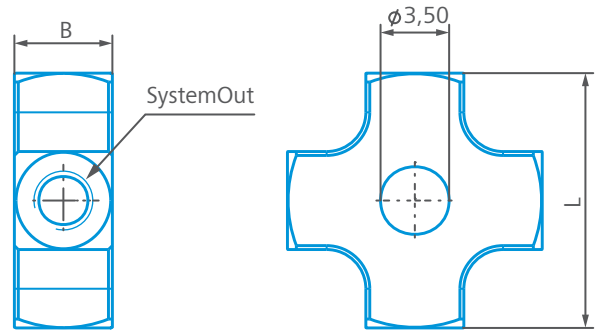

Article-No.	L	B	W1	System out
626103-6110-003	13.00	5.00	90.00	M3 XXT

## Cube 5 x 72°, M3 XXT

5-way anglepiece with 5 M3 XXT connections at a 72° angle and locating hole, rotationally adjustable and clampable using a clamping screw

Connection Type: M3 XXT  
Ø Body (DG): 13  
Material: Titanium

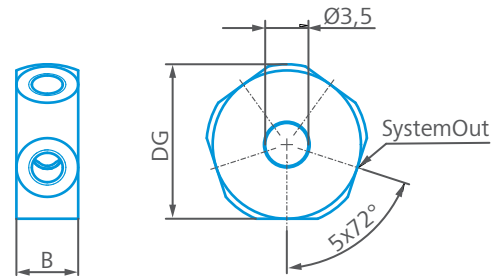

Article-No.	B	W1	System out
626103-6110-025	5.00	72.00	M3 XXT

## Cube 6 x 60°, M3 XXT

6-way anglepiece with 6 M3 XXT connections at a 60° angle and locating hole, rotationally adjustable and clampable using a clamping screw

Connection Type: M3 XXT  
Ø Body (DG): 12  
Material: Titanium

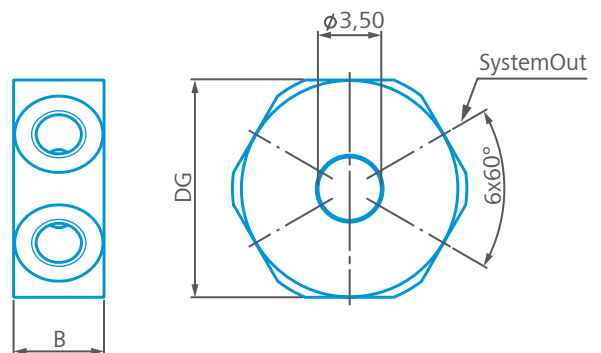

Article-No.	B	W1	System out
626103-6110-006	5.00	60.00	M3 XXT

### Cube 8 x 45°, M3 XXT

8-way anglepiece with 8 M3 XXT connections at a 45° angle and locating hole, rotationally adjustable and clampable using a clamping screw

Connection Type: M3 XXT  
 Ø Body (DG): 14  
 Material: Titanium

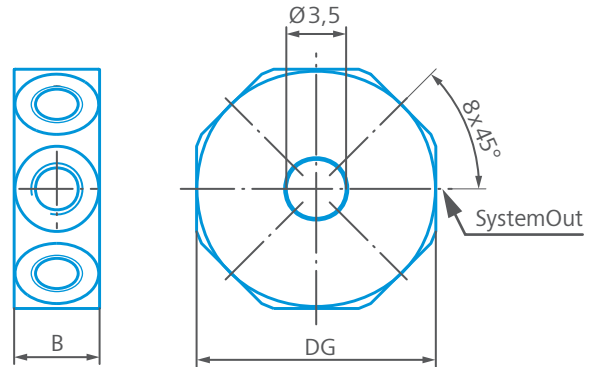

Article-No.	B	W1	System out
626103-6110-007	5.00	45.00	M3 XXT



## M3

M3 REN connecting elements for connecting extensions or styli in a stylus system for use on switching or RENISHAW SP and HPS probes

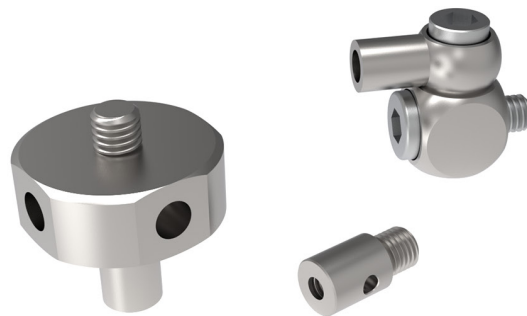

M3 REN connecting elements are used to create multiple or angled styli combinations and star styli with an M3 thread. The M3 REN system is based on 4 mm diameter base bodies and can only be combined with the M3 XXT system in exceptional cases using special adapters.

# Knuckles and rotary elements

Knuckles and rotary elements.

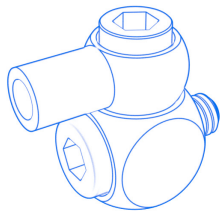

## Knuckle joints complete, stainless steel, M3 REN

Freely adjustable joint angle, angle freely adjustable (0°-90°), M3 REN system with outer diameter 4 mm

Connection Type: M3  
Material: Steel

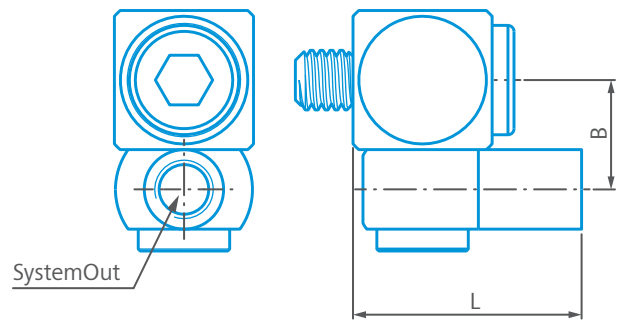

Article-No.	L	B	System out
602030-9102-000	12.00	6.00	M3





# Adapter

Adapters allow you to connect components from different thread systems.

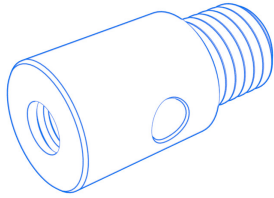

## Thread adapters, M3 REN - X

Thread adapter to extend the screw-on option from M3 REN (Ø4 mm) to smaller thread sizes.

Connection Type: M3  
Ø Body (DG): 4  
Material: Steel

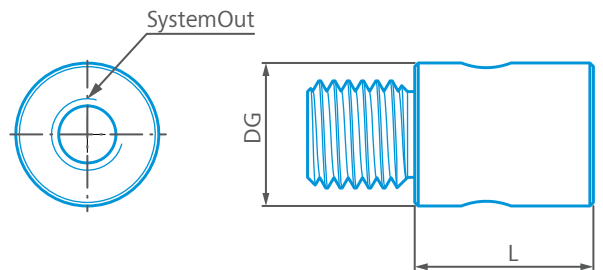

Article-No.	L	System out
602030-8341-000	5.00	M2

# Cubes

Cubes are the most common connection element in a stylus system.

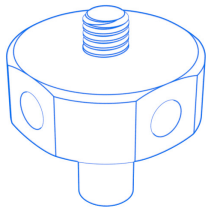

## Cube 4 x 90°, M3 REN

Cube with 4 M3 connections at a 90° angle and a further connection at the front, suitable for M3 REN elements with an outer diameter of 4 mm

Connection Type: M3  
 Ø Body (DG): 4  
 Material: Steel

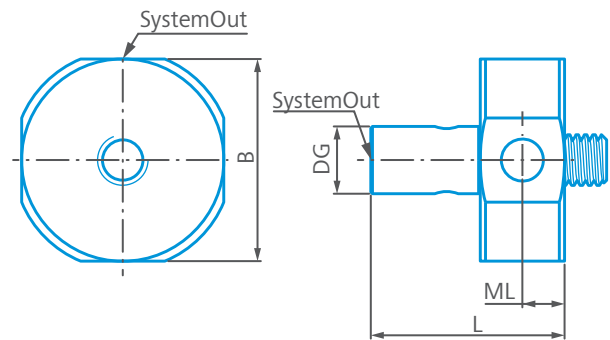

Article-No.	L	B	System out
602030-8382-000	11.50	12.00	M3



## M2

M2 connecting elements for connecting extensions or styli in a stylus system for use on switching or RENISHAW SP and HPS probes



M2 connecting elements are used for the construction of multiple or angled styli combinations and star styli with M2 threads. The M2 system is based on a 3 mm diameter base body and is mainly used in conjunction with RENISHAW probes. Use on other systems can be made possible using special adapters.

# Knuckle and rotary elements

Knuckle and rotary elements.

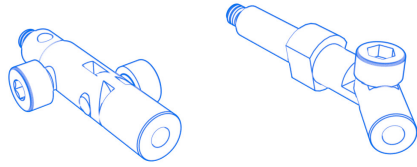

## Knuckle joints complete, M2-M2

Freely adjustable joint angle, angle freely adjustable (0°-90°), M2 system with outer diameter 3 mm

Connection Type: M2  
Material: Steel

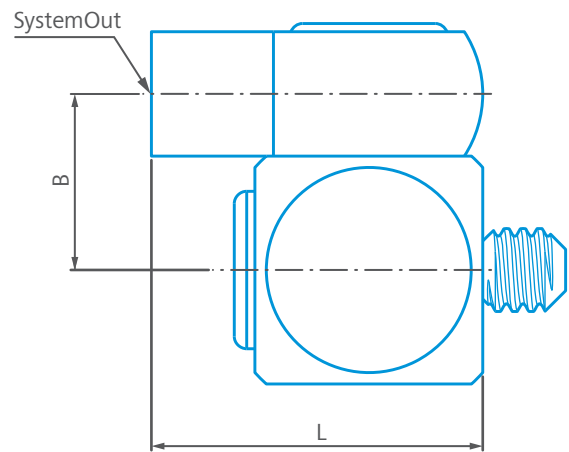

Article-No.	L	B	System out
602030-9101-000	8.00	4.50	M2

## Knuckle joints complete, M2-M2

Freely adjustable joint angle, angle freely adjustable (0°-90°), M2 system with outer diameter 3 mm

Connection Type: M2  
 Ø Body (DG): 4  
 Material: Steel

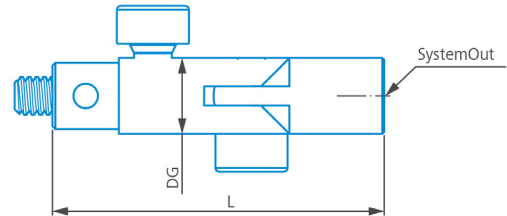

Article-No.	L	System out
602030-9105-000	16.50	M2

## Rotary-knuckle joints, M2-M2

M2 rotary knuckle elements are characterized by their simplicity. The different angular positions result from the rotation around the clamping screw

Connection Type: M2  
 Ø Body (DG): 4  
 Material: Steel

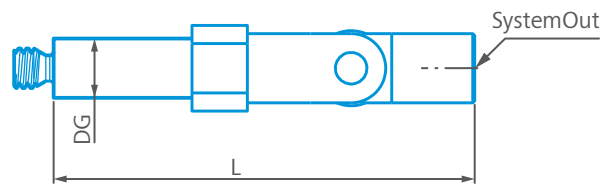

Article-No.	L	System out
626112-5000-004	21.00	M2

# Adapters

Adapters allow you to connect components from different threaded systems.

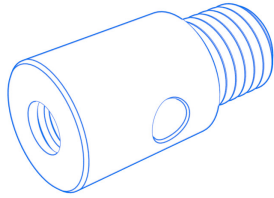

## Thread adapters, M2-X

Thread adapter to extend the screw-on option from M2 to other thread sizes.

Connection Type: M2  
 Ø Body (DG): 4  
 Material: Steel

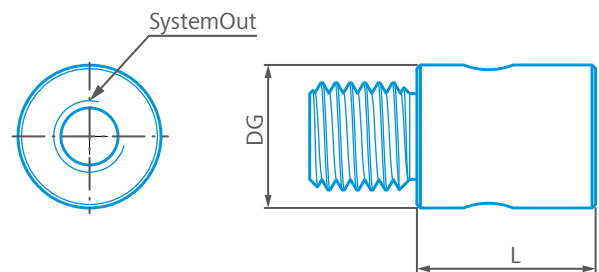

Article-No.	L	System out
602030-8345-000	5.00	M3
000000-1049-178	7.00	M3

# Cubes

Cubes are the most common connection element in a stylus system.

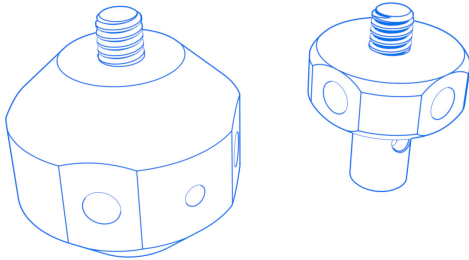

## Cube 4 x 90°, M2

Cube with 4 M2 connections at a 90° angle and a further connection at the front, suitable for M2 elements with an outer diameter of 3 mm

Connection Type: M2  
 Ø Body (DG): 3  
 Material: Steel

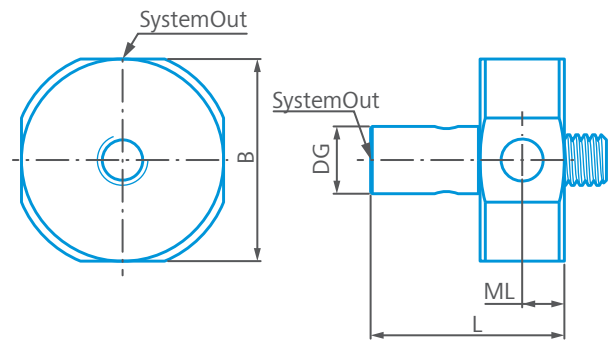

Article-No.	L	B	System out
602030-8381-000	7.00	8.00	M2

## Cube 3 x 120°, M2

Cube with 3 M2 connections at a 120° angle and a further connection at the front, suitable for M2 elements with an outer diameter of 3 mm

Connection Type: M2  
 Ø Body (DG): 3  
 Material: Steel

Article-No.	L	ML	B	System out
626120-0185-000	7.50	1.50	3.00	M2



Seeing beyond

**Carl Zeiss**

Industrielle Messtechnik GmbH  
Carl Zeiss Straße 22  
73446 Oberkochen / Germany

Phone: +49 7364 20-6337  
Fax: +49 7364 20-3870  
Email: [accessories.metrology.global@zeiss.com](mailto:accessories.metrology.global@zeiss.com)  
Internet: [probes.zeiss.com](http://probes.zeiss.com)