



OPMI Lumera i from ZEISS
Efficient Workflow





ZEISS OPMI Lumera i

Shedding light on the details for better decision making

The OPMI LUMERA® family from ZEISS represents excellence in optics and illumination. The ZEISS OPMI Lumera i with ZEISS high-quality visualization technology, including Stereo Coaxial Illumination (SCI), will make a difference in how well you see the details during cataract and retina surgery.

- See the most minute structures during surgery
- Identify the details of the retina
- See overlays of the assistance functions in the eyepiece
- Manage depth of field with a push of a button
- View structures in the eye in natural colors



The 1Chip HD camera system

provides excellent visualization of natural color renditions and crisp anatomical details.

Unmatched ZEISS optics

for exceptional clarity, contrast and light.

RESIGHT® from ZEISS

provides a clear, detailed view of the retina.



Instant Red Reflex

brightly illuminates the eye – due to Stereo Coaxial Illumination (SCI) even with mature cataracts.

External Data Injection System

(EDIS) allows you to see overlays of the assistance functions in the eyepiece of your ZEISS Lumera i.

Deep View depth of field

management system allows you to choose between maximum depth of field or optimum light transmission.

Cataract surgery

For cataract surgery, SCI and CALLISTO eye® from ZEISS provide excellent anterior visualization and highly precise^{1,2,3} assistance functions to accelerate procedural workflow and improve surgical accuracy.

Superior red reflex

With the now firmly established Stereo Coaxial Illumination (SCI) and renowned ZEISS optics, ZEISS OPMI Lumera i brings even the most minute anatomical structures clearly into view. Its highly stable, high-contrast red reflex further enhances detail recognition.

See assistance functions in the eyepiece

Combined with the ZEISS CALLISTO eye, ZEISS OPMI Lumera i provides a series of assistance functions for performing precise^{1,2,3} LRI incisions, capsulorhexis, IOL centration and toric IOL alignment. All assistance functions are injected directly into the eyepiece via EDIS (External Data Injection System) as high-resolution, high-contrast images

and controllable with the wireless foot control panel. This allows you to work comfortably and with full concentration without needing to look up from the eyepiece.

The high-quality HD images and videos can also be displayed on the ZEISS CALLISTO eye touch screen and recorded for documentation.

Assistance functions in the eyepiece

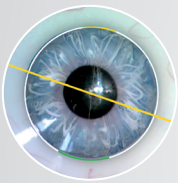

Incision/LRI assistant

Superimpose the exact position and size of the incisions to ensure precise^{1,2,3} surgery.



Rhexis assistant

Superimpose the exact shape and size of the capsulorhexis and center the IOL along the optical axis of the patient's eye.

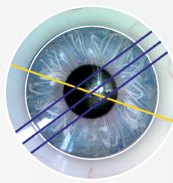

Z ALIGN® – toric assistant

Inject reference axis and target axis in your microscope eyepiece to ensure precise^{1,2,3} toric IOL alignment without corneal markers.

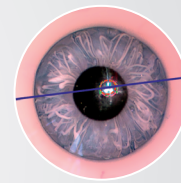

K TRACK®

Visualize corneal curvature in combination with a keratoscope, e. g. in corneal transplantations.

¹ Clinical data of Prof. Findl / Dr. Hirschall presented at ESCRS 2013 – technically verified pre- / intraoperative matching precision $\pm 1.0^\circ$ in mean

² Lackerbauer, C. Modern Solutions for Refractive Cataract Surgery: CALLISTO eye. *Cataract & Refractive Surgery Today*. February 2013.

³ Findl, O. Complications of the CCC. *Cataract & Refractive Surgery Today Europe*. March 2012

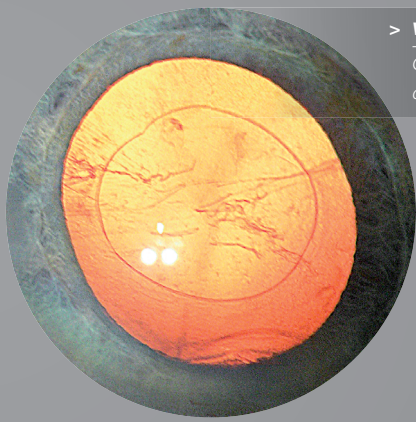

> **Visualize all the details**
 Clearly recognize different structures of the anterior segment with SCI

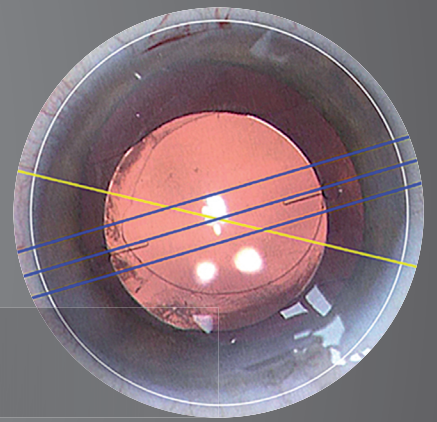

> **Aligned just right**
 Precise^{1,2,3}, markerless alignment of toric IOLs with Z ALIGN

Skip unnecessary workflow steps

The ZEISS OPMI Lumera i is an integral part of the ZEISS Cataract Suite markerless – products designed to work together for precise^{1,2,3} and fast toric IOL alignment. You can skip manual pre- and intraoperative marking steps and manual data transfer; thereby providing a higher level of comfort for you and your patients.



ZEISS CALLISTO eye
 Precise^{1,2,3} premium IOL surgery made easy



Retina surgery

ZEISS OPMI Lumera i and ZEISS RESIGHT fundus viewing systems allow you to clearly recognize the details of the retina.



ZEISS RESIGHT Family provides excellent optical quality⁴

The non-contact fundus viewing systems provide a clear, detailed visualization of the retina. ZEISS RESIGHT 500 incorporates varioscope optics from ZEISS to keep you focused on the retina, without moving the microscope. The innovative lens turret, equipped with two aspheric lenses 128D and

60D, lets you quickly switch to a second lens and magnification. If contact is accidentally made with the patient eye, the system automatically folds up. Because only sterile parts need to be changed, the optics can remain on the surgical microscope in preparation for the next patient. It's that easy.

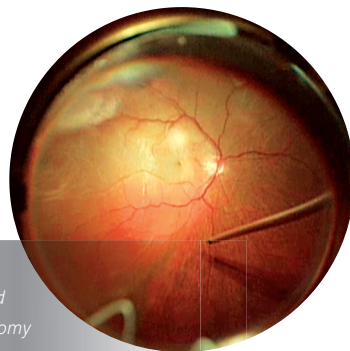

> 128D wide-field lens

For peripheral visualization and a clear overview during vitrectomy

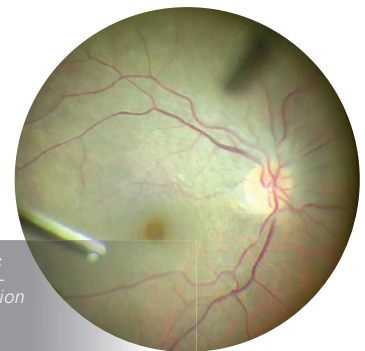

> 60D macular lens

For high magnification of the macula

Full workflow efficiency



Turn the world upside down

The Invertertube combines ZEISS optics and optical inverters into a single ergonomic design that supports a comfortable, upright working posture, without adding to stack height.



Foot control freedom

The foot control panel offers positioning flexibility and the ability to configure functions based on preferences.

⁴ 2nd-generation optics with clearly better overall optical quality and clearly better sharpness, depth and detail recognition for use with the 60D lens – 2013 internal clinical customer survey with international key opinion leader surgeons

Technical specifications

ZEISS OPMI Lumera i

Technical data

Surgical microscope	<p>Apochromatic optics</p> <p>Motorized zoom system, 1:6 zoom ratio, magnification factors $\gamma = 0.4$ to 2.4</p> <p>Focusing range: 50 mm</p> <p>Binocular tube: 0-180° tiltable tube (optional Invertertube®)</p> <p>Eyepieces: 10x (12.5x optional)</p> <p>Objective lens $f = 200$ mm ($f = 175$ mm optional)</p> <p>DeepView: depth of field management system</p>
Illumination	<p>SCI: red reflex illumination and full field illumination, both are adjustable</p> <p>Integrated 408 nm UV barrier filter</p> <p>Blue blocking filter</p> <p>Retinal protection device</p> <p>Fiber optic illumination</p> <p>Optional: fluorescence filter</p>
Light source	12 V, 100 W halogen light source with fully automatic bulb change in case of lamp failure
X-Y coupling	<p>61 mm x 61 mm adjustment range</p> <p>Free programmable button for starting positions of X-Y coupling, focus and zoom, light</p>
Weight of microscope	Approx. 8.5 kg (without tube, objective lens and eyepieces)
Suspension system	<p>Floor stand</p> <p>Maximum load capacity: 14 kg (complete microscope equipment, including accessories)</p>

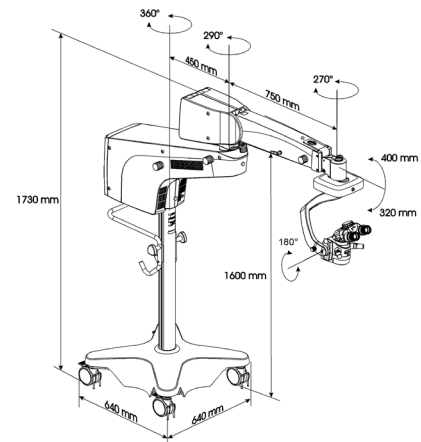



OPMI Lumera i
RESIGHT 500
EDIS



0297

CALLISTO eye



Carl Zeiss Meditec AG
Goeschwitzer Strasse 51–52
07745 Jena
Germany
www.zeiss.com/med

EN_32_010_0106III Printed in Germany. CZ-XII/2018

The contents of the brochure may differ from the current status of approval of the product or service offering in your country. Please contact our regional representatives for more information. Subject to changes in design and scope of delivery and due to ongoing technical development. OPMI LUMERA, RESIGHT, CALLISTO eye, Superlux, Invertertube, Z ALIGN and K TRACK are either trademarks or registered trademarks of Carl Zeiss Meditec AG.
© Carl Zeiss Meditec AG, 2018. All rights reserved.