

# Maintain high resolution at large working distances.

**ZEISS Xradia 510 Versa**  
**Submicron 3D X-ray imaging**



**ZEISS**

Seeing beyond

# Breakthrough Flexibility for 3D Submicron Imaging

- › In Brief
- › The Advantages
- › The Applications
- › The System
- › Technology and Details
- › Service

Achieve new levels of discovery with ZEISS Xradia 510 Versa 3D X-ray microscope (XRM), the industry's premier non-destructive 3D imaging solution. Leading researchers and scientists across the world rely on the signature Resolution at a Distance (RaaD) capability of ZEISS Xradia Versa XRM, ensuring the highest resolution is maintained across longer working distances, to produce remarkable scientific insights and discoveries. Combined with powerful contrast and 4D / *in situ* capabilities for diverse sample sizes, types, and research requirements, the flexible ZEISS Xradia Versa platform delivers unparalleled versatility and a fast time to results for your lab.



# ZEISS Xradia 510 Versa: Flexible. Innovative. Non-destructive.

› In Brief

› **The Advantages**

› The Applications

› The System

› Technology and Details

› Service

## **Define XRM: "Versatile"**

Non-destructive X-ray imaging preserves and extends the use of valuable samples over time. Maximize the power of X-ray microscopy with ZEISS Xradia 510 Versa using flexible 3D imaging for a wide range of samples and research environments. ZEISS Xradia 510 Versa achieves 0.7  $\mu\text{m}$  true spatial resolution with minimum achievable voxel size of 70 nm. Experience increased versatility for soft or low-Z materials with advanced absorption contrast along with innovative phase contrast to overcome the limitations of traditional computed tomography approaches.

## **Achieve Performance Beyond MicroCT**

Extend scientific research beyond the limits of projection-based micro- and nanoCT systems with ZEISS Xradia Versa solutions. Where traditional tomography relies on a single stage of geometric magnification, ZEISS Xradia 510 Versa features a unique two-stage process based on synchrotron-caliber optics. Multi-length scale capabilities enable you to image the same sample across a wide range of magnifications. You will also find that ZEISS Xradia 510 Versa is easy to use by everyone in your busy lab. Accelerate post-processing and image segmentation tasks using advanced machine learning with ZEISS ZEN Intellesis. Boost throughput and image quality with ZEISS DeepRecon Pro and OptiRecon, advanced reconstruction technologies leveraging artificial intelligence and iterative algorithms.

## **Choose the Industry's Premier 4D / *In Situ* Solution**

Uniquely characterize the microstructure of materials in their native environments and study the evolution of properties over time (4D). Breakthrough RaaD enables unprecedented lab-based exploration for a diverse array of applications and sample types, and under varying conditions, in high precision *in situ* rigs. The Xradia Versa *In Situ* Kit allows you to optimize set-up, makes operation easy, and provides a faster time to results.

# Your Insight into the Technology Behind It

- › In Brief
- › **The Advantages**
- › The Applications
- › The System
- › Technology and Details
- › Service

## 3D X-ray Microscopy

Your research requires three-dimensional insight into subjects in their native states, and as they evolve over time. World-leading research facilities, universities, synchrotrons, national, and private labs have deployed X-ray microscopy to meet the growing need for flexible 3D and 4D imaging at high resolution. ZEISS Xradia 510 Versa now makes this caliber of research even more practical for mid-sized imaging centers and industrial laboratories.

X-ray microscopy plays the vital role in your imaging workflow of delivering high resolution and contrast while preserving your valuable samples for future use. Adding a non-destructive stage to the traditional workflow complements your electron and optical microscopy capabilities, easily identifying regions of interest for further study.

ZEISS Xradia Versa solutions employ sophisticated X-ray optics developed for synchrotrons and a unique system architecture. Along with superior resolution and contrast, you will achieve unique multi-length scale imaging, and experience flexible working distances and workflow efficiencies for a wide array of applications and samples.

## XRM Source

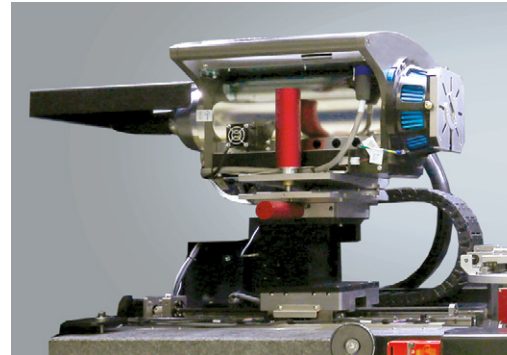

Additionally, ZEISS Xradia 510 Versa uses highly optimized sealed transmission X-ray source technology. Sealed sources mean higher vacuum and longer filament life—eliminating costly, time-consuming, and error-prone frequent filament changes that are required in lower vacuum open source microCT systems—enhancing source stability and lifetime, while providing consistent performance.

## XRM Detector Technology

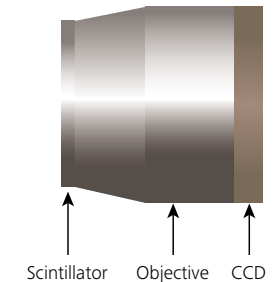
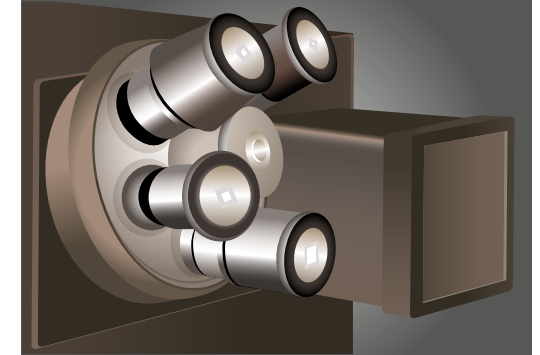

# Your Insight into the Technology Behind It

- › In Brief
- › **The Advantages**
- › The Applications
- › The System
- › Technology and Details
- › Service

## ZEISS XRM: Architected for Your Advantage

Use the two-stage magnification technique offered by ZEISS Xradia Versa to uniquely achieve Raad, which enables you to effectively study the widest range of sample sizes, including those within *in situ* chambers.

Your sample images are initially enlarged through geometric magnification as they are in conventional microCT. In the second stage, a scintillator converts X-rays to visible light, which is then optically magnified. Reducing dependence upon geometric magnification enables ZEISS Xradia Versa solutions to maintain submicron spatial resolution down to 700 nm at large working distances.

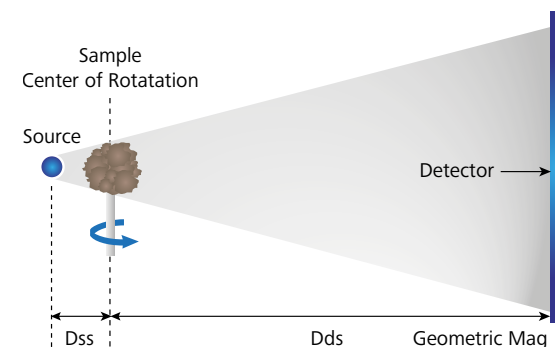

Conventional MicroCT Architecture

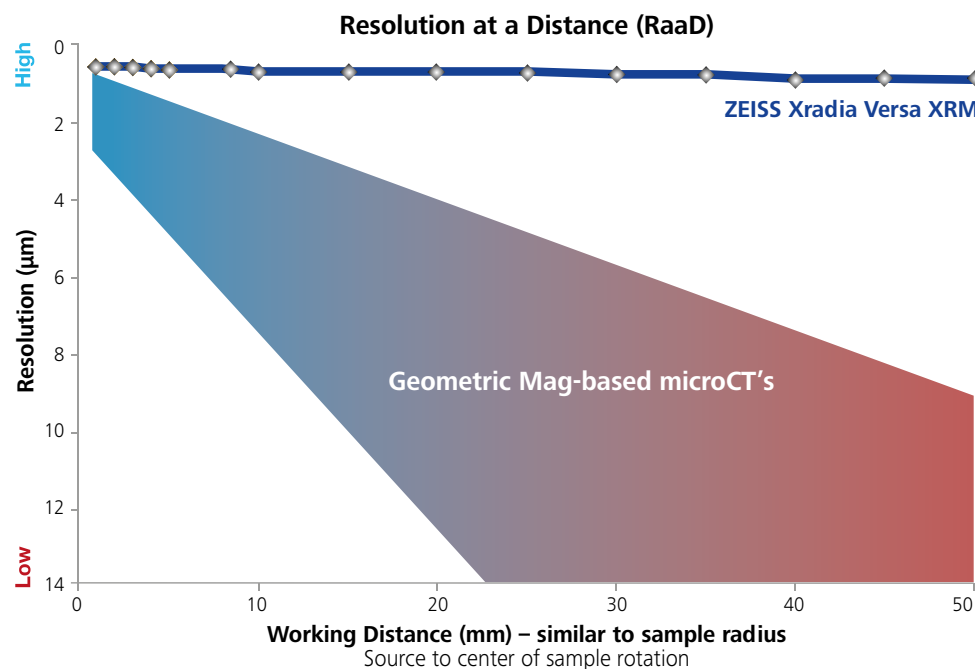

High resolution is maintained for large samples

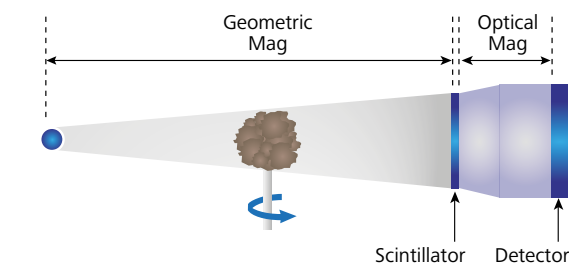

ZEISS XRM Two-stage Magnification Architecture

# Your Insight into the Technology Behind It

- › In Brief
- › **The Advantages**
- › The Applications
- › The System
- › Technology and Details
- › Service

## Achieve True Resolution

ZEISS Xradia Versa solutions deliver powerful 3D X-ray imaging, maintaining true submicron spatial resolution across varying distances, sample sizes, and environments. ZEISS XRM are specified on true spatial resolution, the most meaningful measurement of your microscope's performance.

Spatial resolution refers to the minimum separation at which your imaging system can resolve a feature pair. You would typically

measure it by imaging a standardized resolution target with progressively smaller line-space pairs. Spatial resolution accounts for critical characteristics such as X-ray source spot size, detector resolution, magnification geometry, and vibrational, electrical and thermal stability. Other terms such as "voxel," "spot size," "detail detectability," and "nominal resolution" do not convey your system's full performance.

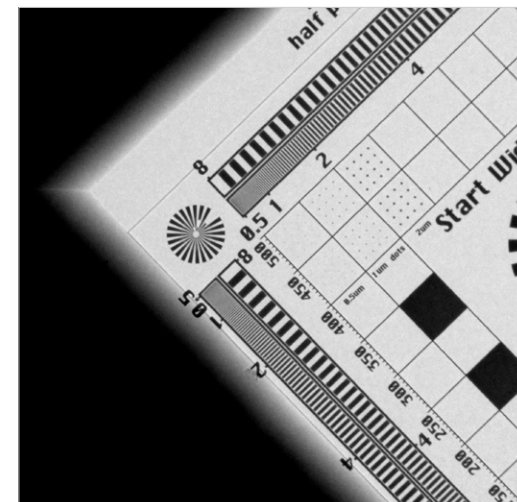

	Resolution on Traditional microCT Systems	Higher Resolution on ZEISS 3D X-ray Microscopes
<b>Spot size</b>	Suffer from spot-size dependent blur	Unique dual-stage magnification enables performance not limited by spot size
<b>Sample size</b>	Only able to achieve high resolution on smallest sample sizes	ZEISS XRM RaaD technology enables highest resolution across diverse sample sizes and working distances
<b>Sample type</b>	Limited to small, low-Z samples using low kV X-ray beam	Energy-tuned detectors enable highest resolution across broad ranges of sample types and densities
<b>Instrument setup</b>	Require installation of different source targets/ filaments for different operating needs	Source is designed to operate across the entire application space (30-160 kv) with a wide range of detectors, eliminating the need for manual hardware reconfigurations

# Your Insight into the Technology Behind It

- › In Brief
- › **The Advantages**
- › The Applications
- › The System
- › Technology and Details
- › Service

## Gain an Edge in Contrast

Your imaging requires superior contrast capabilities to reveal details you need to visualize and quantify features. ZEISS Xradia Versa deliver flexible, high contrast imaging for even your most challenging materials – low atomic number (low Z) materials, soft tissue, polymers, fossilized organisms encased in amber, and other materials of low contrast.

Our comprehensive approach employs proprietary enhanced absorption contrast detectors that provide you with superior contrast by maximizing collection of low energy photons while minimizing collection of contrast-reducing high energy photons.

In addition, tunable propagation phase contrast measures the refraction of X-ray photons at material transitions to allow you to visualize features displaying little or no contrast during absorption imaging.

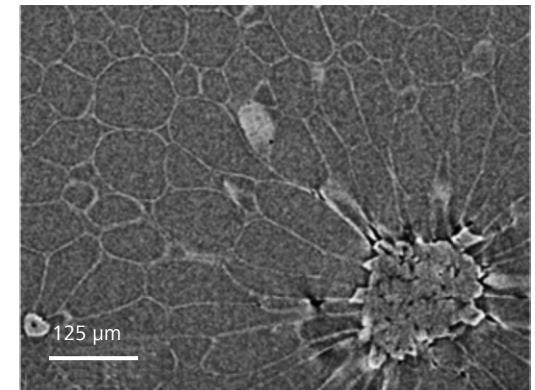
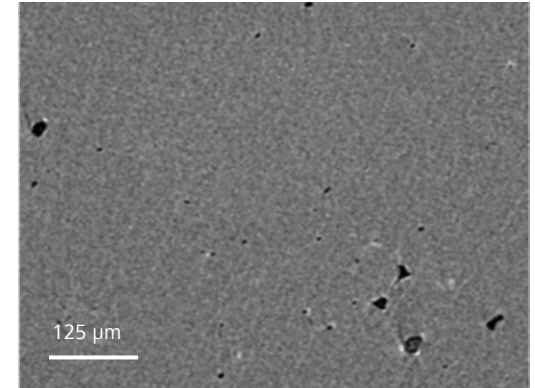

*Pear imaged with absorption contrast – no visibility of cell walls (top), and pear imaged with phase contrast, showing details of cell walls in normal cells and stone cells (bottom).*

# Your Insight into the Technology Behind It

- › In Brief
- › **The Advantages**
- › The Applications
- › The System
- › Technology and Details
- › Service

## Our Super Simple User Interface Enables Efficient Workflows

All of the features introduced by the ZEISS Xradia 510 Versa are seamlessly integrated within the Scout-and-Scan Control System, an efficient workflow environment that allows you to easily scout a region of interest and specify scanning parameters. The easy-to-use system is ideal for a central lab-type setting where your users may have a wide variety of experience levels.

The interface maintains the flexibility for which ZEISS Xradia Versa systems are known, enabling you to set-up scans even more easily. Scout-and-Scan software also offers recipe-based repeatability, which is especially useful for your *in situ* and 4D research, and enables you to have greater control and efficiency for future work.



Set, Load, Scout, Scan, Run. It's that simple.

## Scout-and-Scan Advantages

- Internal camera for sample viewing
- Recipe control (set, save, recall)
- Multiple energies
- Multiple samples with Autoloader option
- Micropositioning capability with a simple mouse click



# Your Insight into the Technology Behind It

- › In Brief
- › **The Advantages**
- › The Applications
- › The System
- › Technology and Details
- › Service

## SmartShield – Protect Your Sample and Optimize Experiment Set-up

ZEISS SmartShield is a simple solution that protects your sample and your microscope, working within the ZEISS Scout-and-Scan control system. ZEISS SmartShield wraps a digital “envelope” around your sample with an easy click of a button. This automated solution allows you to confidently bring your sample even closer to the source and detector. With ZEISS SmartShield, new and advanced users alike can experience an elegant sample set-up workflow and efficient navigation of the ZEISS Xradia Versa XRM system.

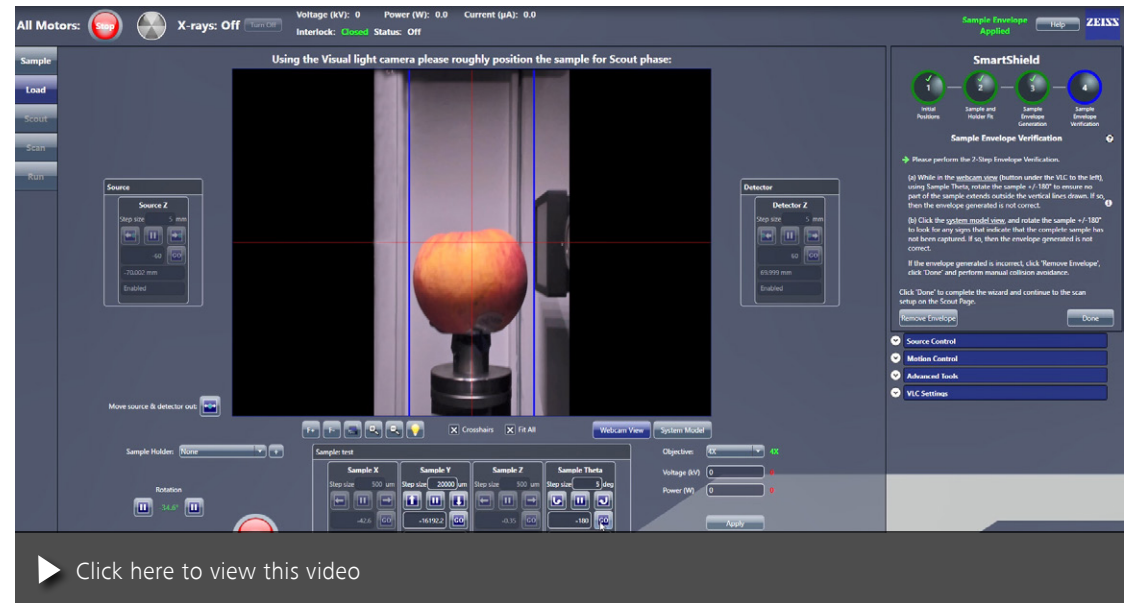

▶ [Click here to view this video](#)

Watch this video and gain insights into the workflow guided by SmartShield.

## What SmartShield Offers:

- Fully integrated rapid envelope creation within Scout-and-Scan
- 3D awareness for sample and instrument safety
- Enhanced operator efficiency during setup

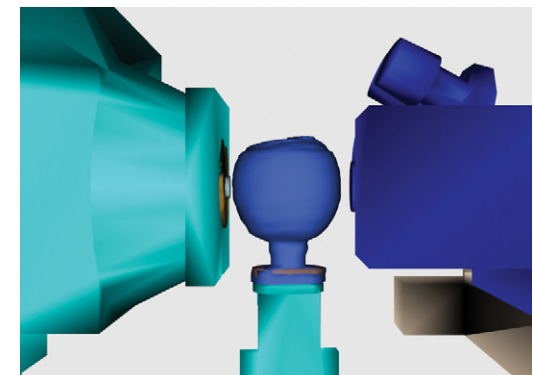

Digital envelope of the sample created by ZEISS SmartShield

# Your Insight into the Technology Behind It

- › In Brief
- › **The Advantages**
- › The Applications
- › The System
- › Technology and Details
- › Service

## Advanced Reconstruction Toolbox

The Advanced Reconstruction Toolbox is an innovative platform on which you can continuously access state-of-the-art reconstruction technologies from ZEISS to enrich your research and increase the return on investment of your ZEISS Xradia 3D XRM.

These unique offerings from ZEISS leverage deep understanding of both X-ray physics and customer applications to solve some of the hardest imaging challenges in new and innovative ways. These optional modules are workstation-based solutions that provide easy access and usability.

	FDK Standard Analytical Reconstruction	OptiRecon Iterative Reconstruction	DeepRecon Pro AI (Deep-Learning) based Reconstruction
<b>Throughput</b>	1x	up to 4x	up to 10x
<b>Image Quality*</b>	Standard	Better	Best
<b>Ease-of-Use</b>	Minimal	Requires parameter optimization	One-click setup
<b>Applicability</b>	Repetitive and non-repetitive workflows		
<small>* Image quality refers to the contrast-to-noise ratio and the relative performance of reconstruction technologies is shown.</small>			

## ZEISS DeepRecon

The first commercially available deep learning reconstruction technology enables you to increase throughput by up to 10x without sacrificing novel XRM RaaS. Alternatively, keep the same number of projections and enhance the image quality further. DeepRecon uniquely harvests the hidden opportunities in big data generated by your XRM and provides significant AI-driven speed or image quality improvement.

ZEISS offers DeepRecon technology in 2 forms – 1) DeepRecon Pro, and 2) DeepRecon Custom – both leveraging AI to provide unprecedented image quality with unparalleled speed.

ZEISS DeepRecon Pro is an innovative AI-based technology bringing superior throughput and image quality benefits across a wide range of applications. DeepRecon Pro is applicable to both unique samples as well as semi-repetitive and repetitive workflows. Customers can now self-train new machine learning network models on-site with an extremely easy-to-use interface. The one-click workflow of DeepRecon Pro eliminates the need for a machine learning expert and can be seamlessly operated by even a novice user. ZEISS DeepRecon Custom is targeted specifically for repetitive workflow applications to further boost XRM performance beyond DeepRecon Pro. Customers can closely collaborate with ZEISS to develop custom-created network models that precisely fits their repetitive application needs.

## ZEISS OptiRecon

A fast and efficient algorithm-based technology that delivers iterative reconstruction from your desktop, allowing you to achieve up to 4x faster scan times or enhanced image quality with equivalent throughput.

OptiRecon is an economical solution offering superior interior tomography or throughput on a broad class of samples.

## ZEISS PhaseEvolve

ZEISS PhaseEvolve is a post-processing reconstruction algorithm that enhances the image contrast by revealing material contrast uniquely inherent to X-ray microscopy, which can often be obscured by phase effects in low-medium density samples or high resolution datasets. Perform more accurate quantitative analysis with improved contrast and segmentation of your results.

# Your Insight into the Technology Behind It

- › In Brief
- › **The Advantages**
- › The Applications
- › The System
- › Technology and Details
- › Service

## ZEISS DeepRecon Pro – How It Works in Materials Science

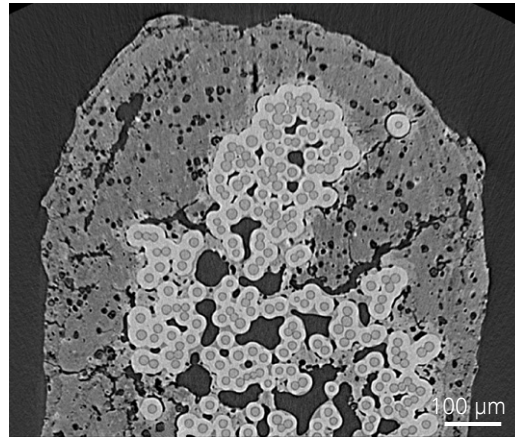

Standard reconstruction (FDK): Scan time 9 hrs (3001 projections)

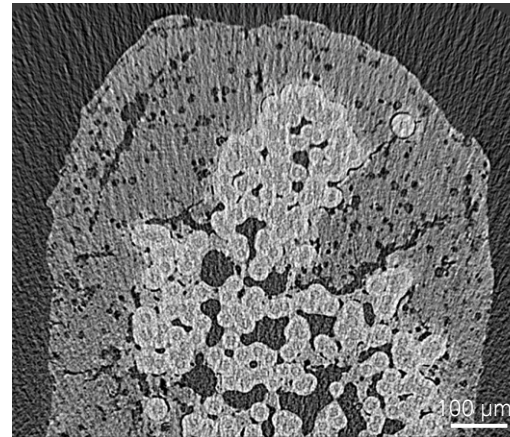

Standard reconstruction (FDK): Scan time 53 mins (301 projections)

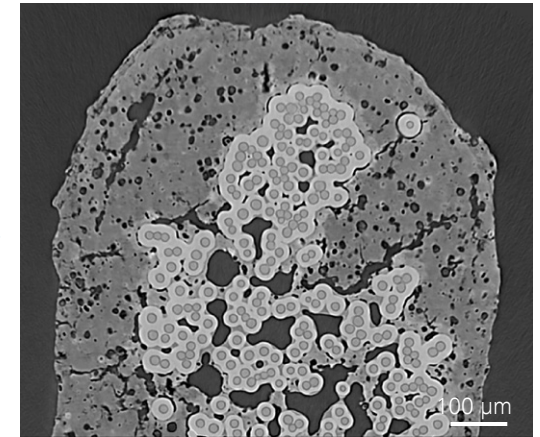

DeepRecon Pro: Scan time 53 mins (301 projections)

DeepRecon Pro used for throughput improvement for Ceramic Matrix Composite (CMC) sample, achieving 10x throughput improvement without sacrificing image quality. This would allow for much higher temporal resolution for in situ studies.

## ZEISS DeepRecon Pro – How It Works in Electronics

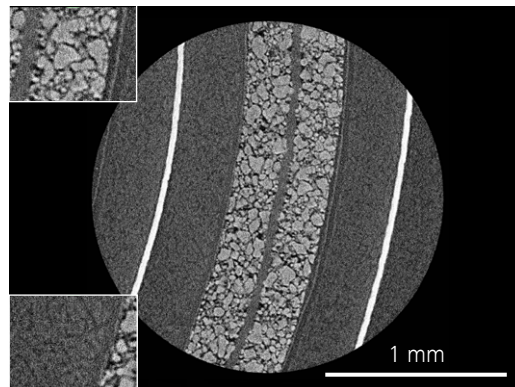

Standard Reconstruction (FDK)

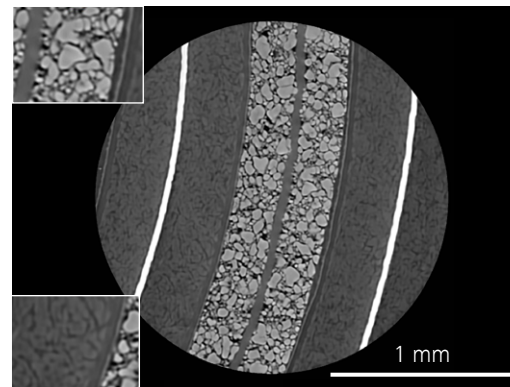

DeepRecon Pro

DeepRecon Pro used for image quality improvement for a smartwatch battery. DeepRecon Pro both improves the clarity of cathode grains and polymer separator. It also allows for the recovery of features otherwise obscured by image noise, such as the electrolyte saturated anode.

# Your Insight into the Technology Behind It

- › In Brief
- › **The Advantages**
- › The Applications
- › The System
- › Technology and Details
- › Service

## ZEISS OptiRecon – How It Works in Electronics

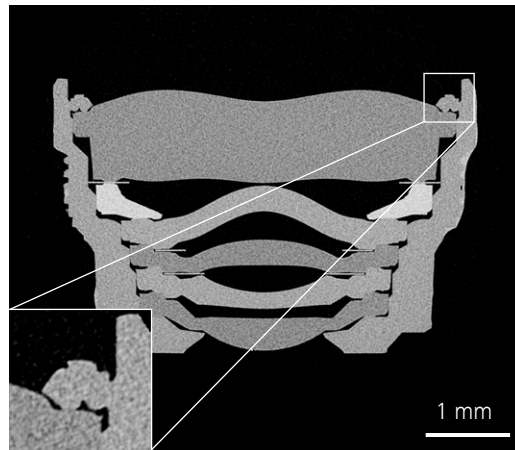

Standard reconstruction: Scan time 90 minutes (1200 projections)

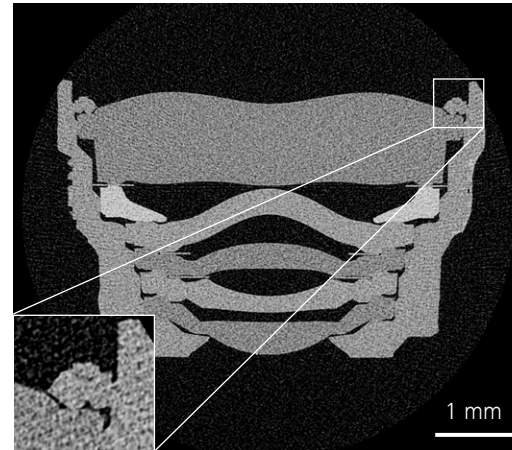

Standard reconstruction: Scan time 22 minutes (300 projections)

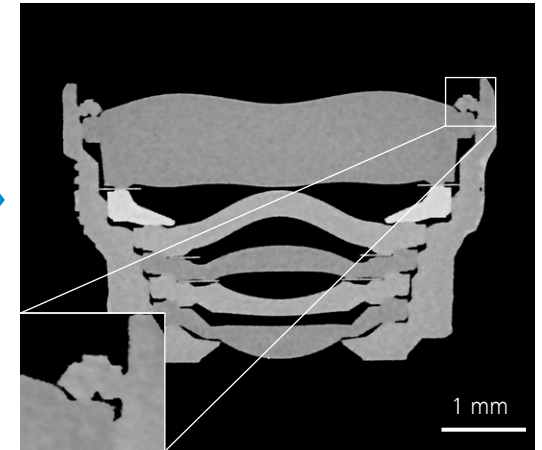

OptiRecon: Scan time 22 minutes (300 projections)

Observe the performance of OptiRecon in a workflow performed on an electronics sample. Analyze integration issues in a smart phone camera lens, now 4x faster using OptiRecon.

## ZEISS PhaseEvolve – How It Works in Materials Science

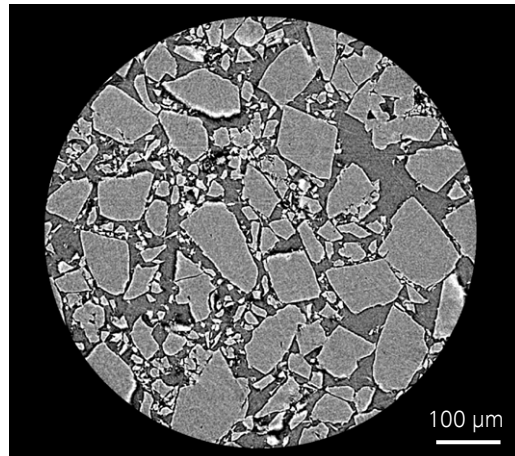

Standard reconstruction

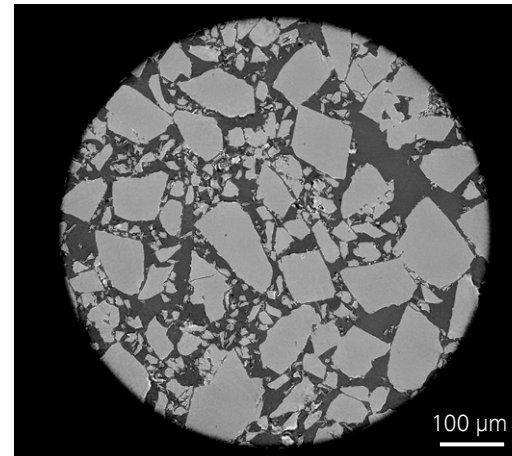

PhaseEvolve applied reconstruction

Application of PhaseEvolve to a pharmaceutical powder sample. High resolution or low kV imaging can result in inherent material contrast being obscured by phase contrast artifacts. PhaseEvolve effectively removes phase fringes to enhance image contrast and improve segmentation results.

# Your Insight into the Technology Behind It

- › In Brief
- › **The Advantages**
- › The Applications
- › The System
- › Technology and Details
- › Service

## FPX to Image Even Larger Samples with High Throughput

Optional Flat Panel Extension (FPX) delivers large-sample, high throughput scanning with ZEISS best-in-class image quality. ZEISS Xradia Versa FPX enhances imaging flexibility and creates workflow efficiencies with an all-in-one system for industrial and academic research.

ZEISS Scout-and-Zoom is a unique capability of ZEISS X-ray microscopes that leverages FPX to perform a low resolution, large field of view “scout” scan and identify interior regions for higher resolution “zoom” scans on a variety of different sample types.

This powerful technique is achieved only by the unique Versa dual magnification microscope objectives that enable RaaD and can be used to accurately identify regions of interest in several applications. Image a specific region of trabecular bone inside an intact bone, a particular solder bump in the interior of a large semiconductor package, or a specific area of cracks or voids in a composite sample.

Now, advanced reconstruction technologies, such as OptiRecon and DeepRecon, can improve the image quality of challenging “Zoom” scans without increasing image acquisition time.

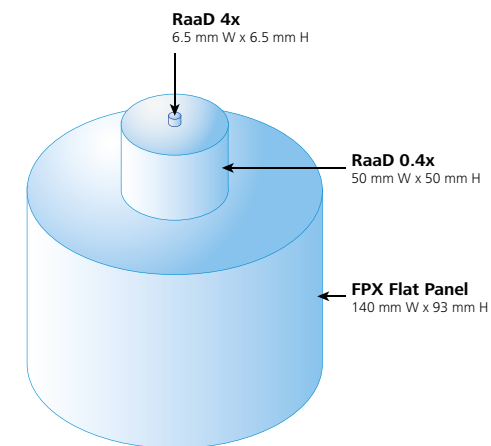

Single FOV reconstruction volume comparison

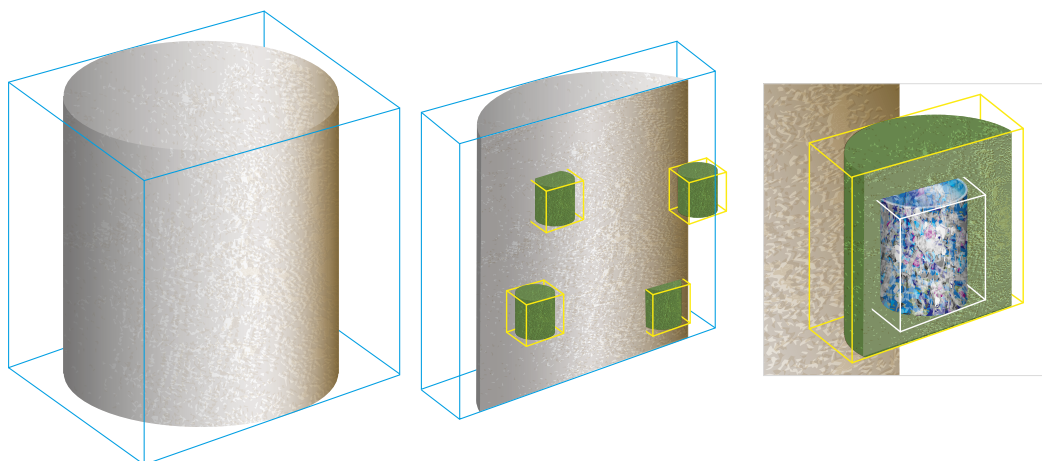

Scout-and-Zoom large sample at high throughput with high resolution sub-sampling

FPX Specifications	
Flat Panel Detector Array	3072 px × 1944 px
Single FOV	140 mm diameter 93 mm height
Maximum field of view with automated stitching	140 mm diameter 165 mm height

# Your Insight into the Technology Behind It

- › In Brief
- › **The Advantages**
- › The Applications
- › The System
- › Technology and Details
- › Service

## Large Object Scout-and-Zoom Workflows with FPX

Three-stage Scout-and-Zoom workflow. Rapidly scan large field of view with FPX and then zoom to regions of interest with RaaD objectives.

**FPX**

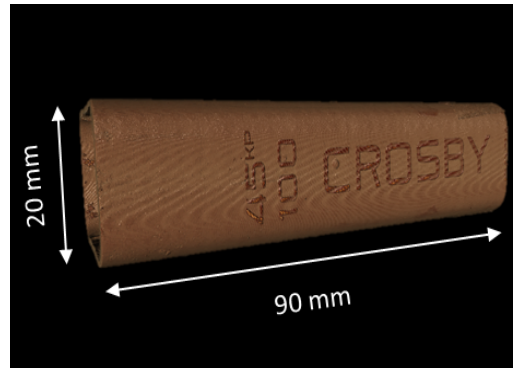

Sample set: hockey stick fiber-reinforced composite

**0.4x**

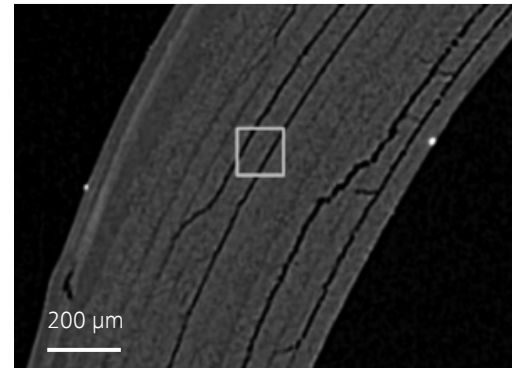

**4x**

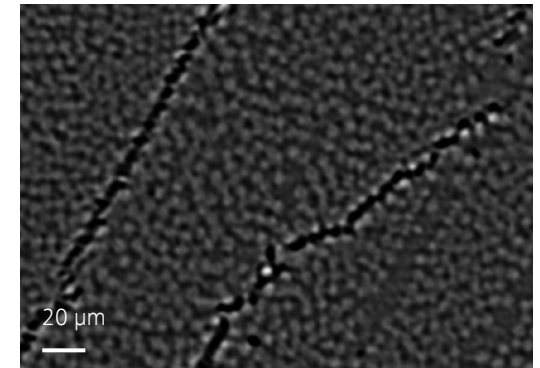

**FPX**

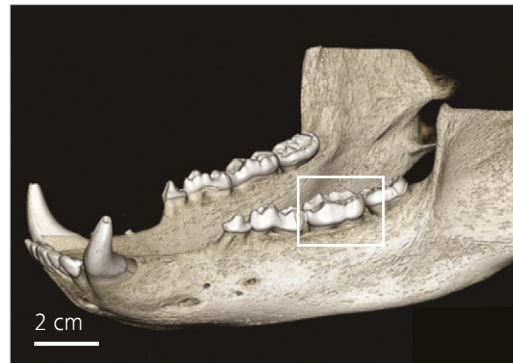

Sample set: bear jaw, 15 cm long

**0.4x**

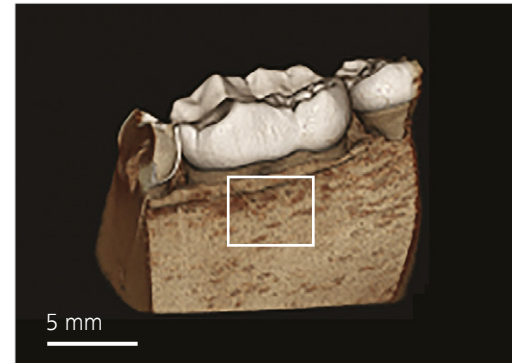

**4x**

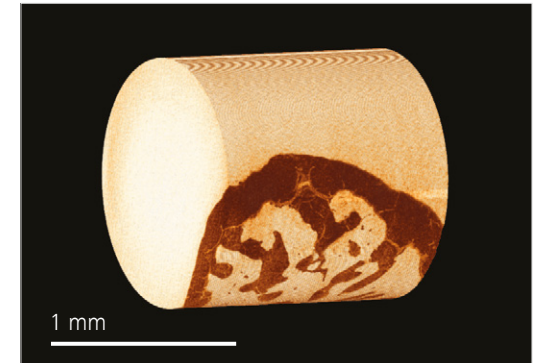

# Your Insight into the Technology Behind It

- › In Brief
- › **The Advantages**
- › The Applications
- › The System
- › Technology and Details
- › Service

## Enhance Your Experimental Possibilities by Adding the ZEISS *In Situ* Interface Kit to Your XRM

Continuing to push the limits for scientific advancement, ZEISS Xradia Versa solutions have evolved to provide you with the industry's premier 3D imaging solution for the widest variety of *in situ* rigs, from high pressure flow cells to tension, compression, and thermal stages.

ZEISS XRM uniquely enable the most advanced *in situ* experiments. These studies require samples to be further away from the X-ray source to accommodate various types of *in situ* rigs. On traditional microCT systems, this significantly limits the resolution achievable for your samples. ZEISS XRM are uniquely equipped with dual-stage magnification architecture with RaaD technology that enables the highest resolution for *in situ* imaging.

You can add the optional *In Situ* Interface Kit to all ZEISS Xradia Versa instruments. Contents include a mechanical integration kit, a robust cabling guide and other facilities (feed-throughs) along with recipe-based software that simplifies your operation from within the ZEISS Scout-and-Scan user interface. Experience the highest level of stability, flexibility, and controlled integration of *in situ* devices on the ZEISS Xradia Versa, which benefit from an optical architecture that doesn't compromise resolution in variable environmental conditions.

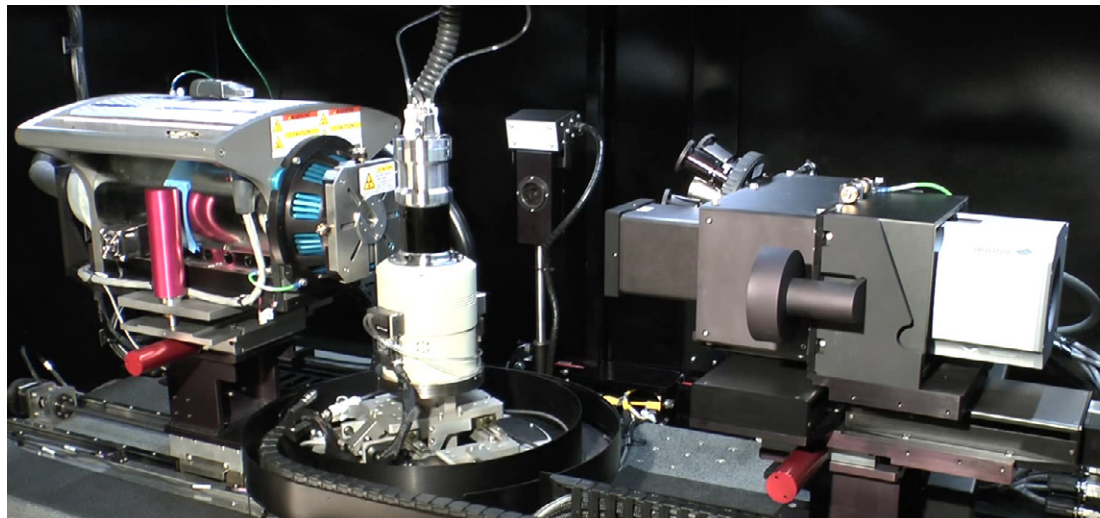

Making the industry's best in situ solution even better: In situ kit tracking with Deben thermomechanical stage. In situ kit available for all Versa systems; image here is representative of the Xradia 510 Versa.

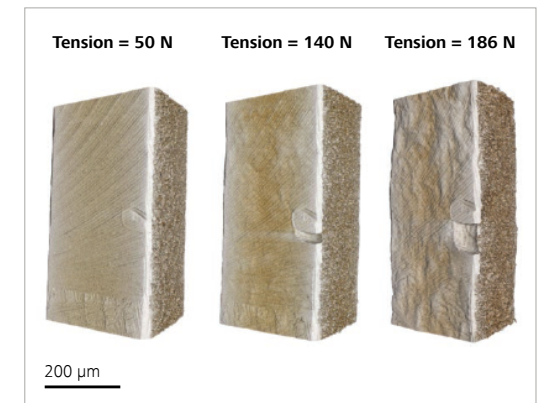

Tensile testing of a steel laser weld under increasing load. The data reveal a crack initiating and propagating from a rough surface imperfection, as well as the elongation of internal voids. Sample courtesy of Sandia National Laboratories.

# Your Insight into the Technology Behind It

- › In Brief
- › **The Advantages**
- › The Applications
- › The System
- › Technology and Details
- › Service

## **Autoloader to Increase Your Sample Handling Efficiency**

Maximize your instrument's utilization by minimizing user intervention with the optional ZEISS Autoloader, available for all instruments in the ZEISS Xradia Versa series of submicron 3D X-ray microscopes. Reduce the frequency of user interaction and increase productivity by enabling multiple jobs to run. Load up to 14 sample stations, which can support up to 70 samples, queue, and allow to run all day, or off-shift.

The software provides you with the flexibility to re-order, cancel, or stop the queue to insert a high priority sample at any time. An e-mail/text notification feature in the Scout-and-Scan user interface provides timely updates on queue progress. Autoloader also enables a workflow solution for high volume repetitive scanning of like samples.

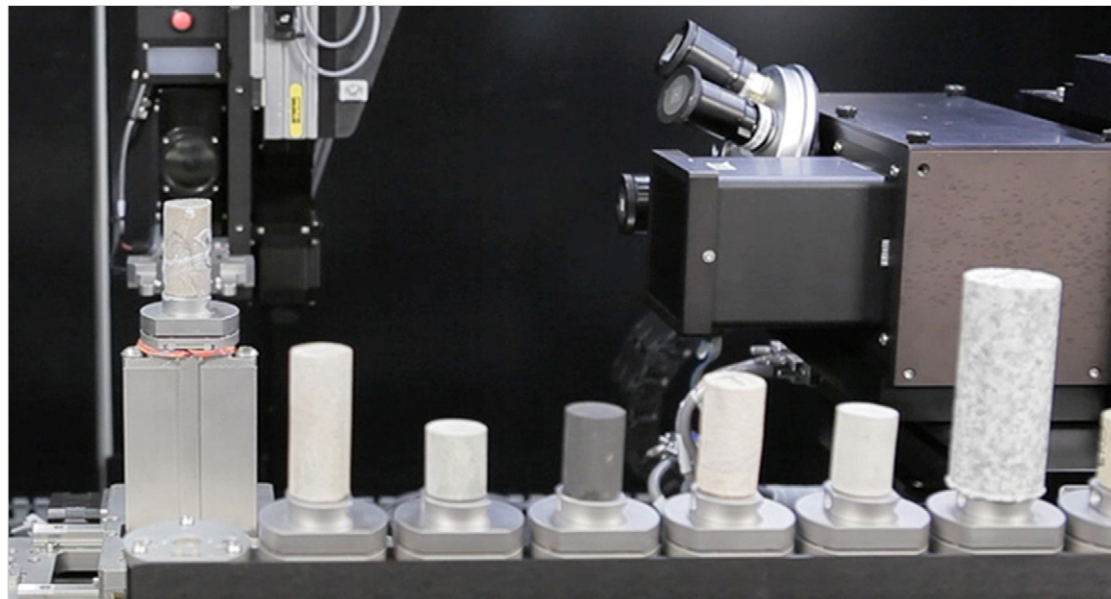

*Autoloader option enables you to program up to 14 samples at a time to run sequentially.*



# Your Insight into the Technology Behind It

- › In Brief
- › **The Advantages**
- › The Applications
- › The System
- › Technology and Details
- › Service

## Dragonfly Pro: Your Visual Pathway to Quantitative Answers

Dragonfly Pro is advanced 3D visualization and analysis software from Object Research Systems (ORS), and offered exclusively by ZEISS for processing SEM, FIB-SEM, and XRM data. Using advanced visualization techniques and state-of-the-art volume rendering, Dragonfly Pro enables high definition exploration into the details and properties of your datasets. You can register multiple datasets within the same workspace, and easily manipulate your 2D and 3D data with an extensive image processing feature set.

### Full featured 3D visualization and data analysis platform

- Find quantitative answers with powerful yet intuitive segmentation and analytical tools
- Create compelling visual media

### Engineered to support the needs of microscopists

- A common workspace for integrating multi-scale correlative microscopy, spanning cm to nm
- Simple, intuitive user interface
- Customizable with Python

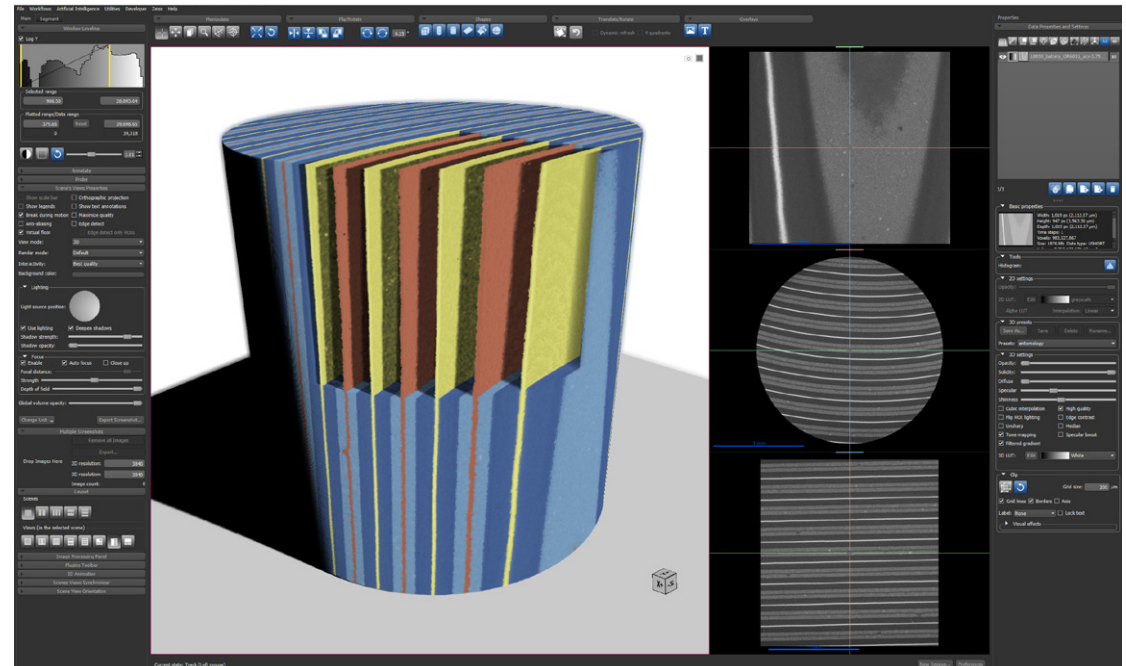

### Process data acquired by ZEISS microscopes

- Read and write various formats including .txm and .czi
- Auto-process and apply macros to automate workflow
- Offered exclusively through ZEISS

### Expand the software through optional modules

- Deep Learning for advanced segmentation
- Bone Analysis for accurate specialized metrics

# Your Insight into the Technology Behind It

- › In Brief
- › **The Advantages**
- › The Applications
- › The System
- › Technology and Details
- › Service

Dragonfly Pro from ORS is a configurable software package. You can tailor the tools that are optimal to your workflow, and choose from plug-ins that allow you to control registration, map differences, and customize appearance. Dragonfly Pro also supports regular and unstructured surface meshes, and contains advanced editing tools to create regions of interest from a mesh and vice versa. With the Plug-In Development Kit (PDK), you can leverage the Dragonfly Pro core technology to quickly build specialized workflows.

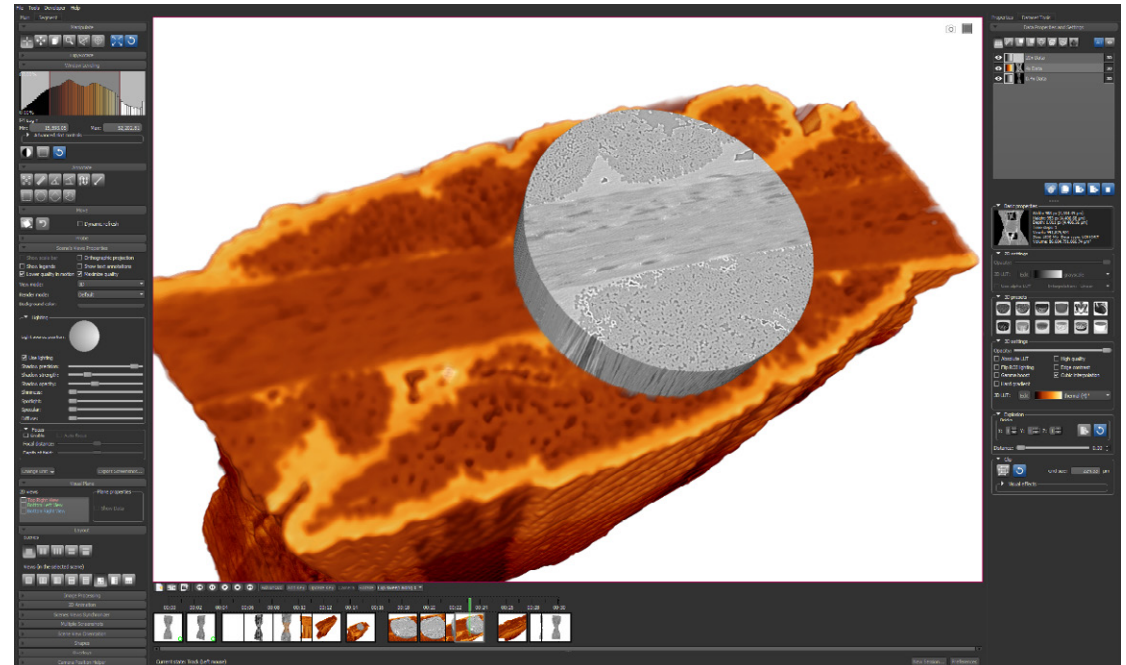

Tailor the tools that are optimal to your workflow: choose plug-ins that allow you to control registration, map differences, and customize appearance. Ceramic matrix composite, imaged on a ZEISS Xradia Versa microscope. Sample courtesy of Dr. David Marshall, University of Colorado, U.S.

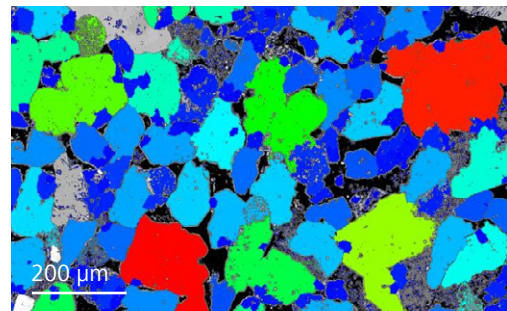

Compute morphometric properties to visualize quantitative answers: Sandstone imaged by SEM showing volume distribution of grains in sandstone. Courtesy of Imperial College, U.K.

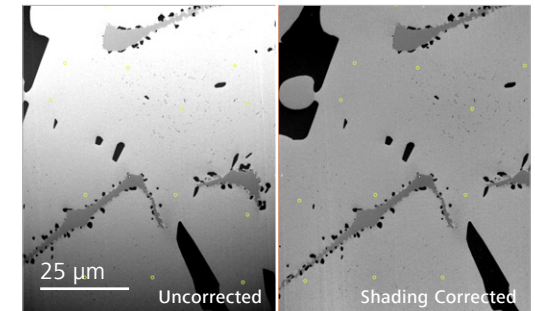

Image filtering: Correct shading, denoise. Nickel carbide alloy imaged by Crossbeam FIB-SEM. Dataset courtesy of P. Bala, AGH University, Poland.

# Precisely Tailored to Your Applications

- › In Brief
- › The Advantages
- › **The Applications**
- › The System
- › Technology and Details
- › Service

	Task	ZEISS Xradia 510 Versa offers
<b>Materials Research</b>	Expand your materials research capabilities from visualizing cracks in soft composite materials to measuring porosity in steel, all with a single system	View into deeply buried microstructures that may be unobservable with 2D surface imaging such as optical microscopy, SEM, and AFM
	Perform <i>in situ</i> studies by imaging under varying conditions such as tensile, compression, desiccation, wetting and temperature variations	You have the ability to maintain resolution at a distance for <i>in situ</i> imaging experiments, allowing you to study a wide variety of sample sizes and shapes using various <i>in situ</i> apparatus. With the nondestructive nature of X-ray, you can additionally understand the impact of these varying conditions over time.
<b>Life Sciences</b>	Quantify osteocyte properties for bone morphology, map neural networks, study vasculature, and understand development of bio structures	Leverage the highest resolution and highest contrast for exploring unstained and stained hard and soft tissues
<b>Raw Materials</b>	Characterize and quantify pore structure, analyze mineral liberation efforts, understand crack propagation, study carbon sequestration effectiveness	Experience the most accurate 3D, submicron characterization of rock pore structures for digital rock simulations and perform <i>in situ</i> multiphase fluid flow studies
<b>Semiconductor and Electronics</b>	Optimize your processes and analyze failures	Use non-destructive submicron imaging of intact packages for defect localization and characterization, complementing or replacing physical cross-sectioning
<b>Battery and Energy Storage</b>	Analyze failures and perform quality inspections of separator and electrodes for defects and inclusions; track aging mechanisms	Use non-destructive 4D <i>in situ</i> imaging of intact energy materials without destroying the functionality of the device or disturbing the intricate internal structures
<b>Manufacturing Technology</b>	Analyze internal tomographies of 3D printed parts	Use Scout-and-Zoom to identify a specific region of interest for investigation, and high resolution imaging to see fine details such as un-melted particles, high-Z inclusions, and small voids, without any sample manipulation

# ZEISS Xradia 510 Versa at Work

- › In Brief
- › The Advantages
- › **The Applications**
- › The System
- › Technology and Details
- › Service

## Materials Research

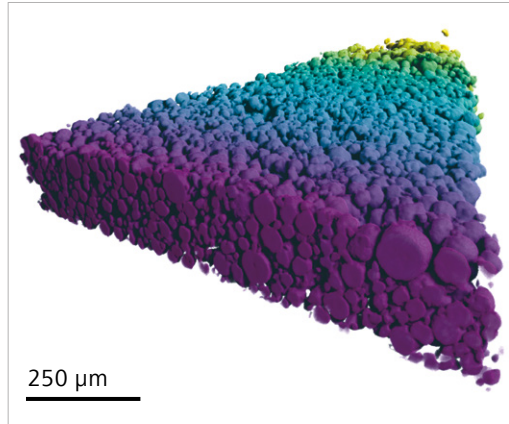

*Lithium ion battery cathode electrode*

## Life Sciences

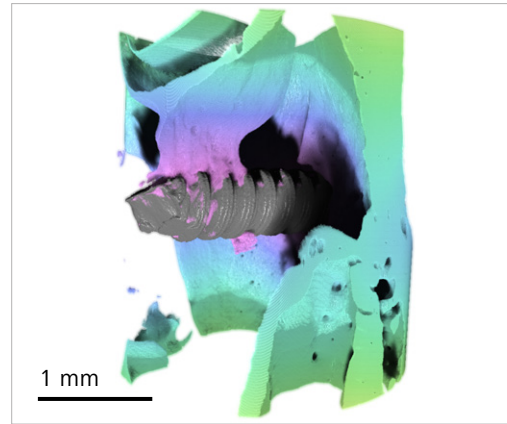

*Dental implant showing attachment points and new growth*

## Semiconductor

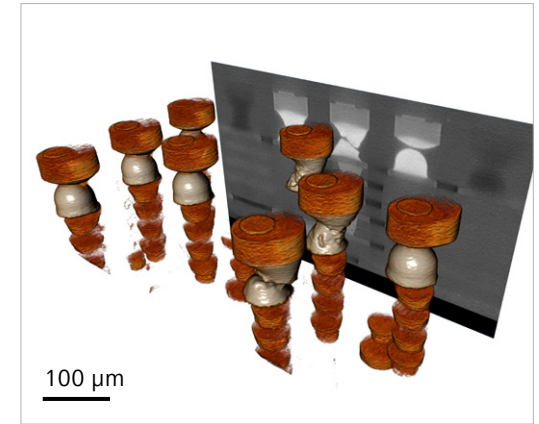

*Non-destructively image flip chip bump defects*

## Raw Materials

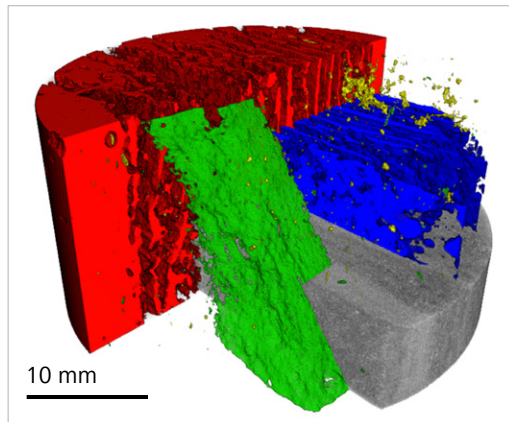

*Classification of shale heterogeneity*

## Electronics

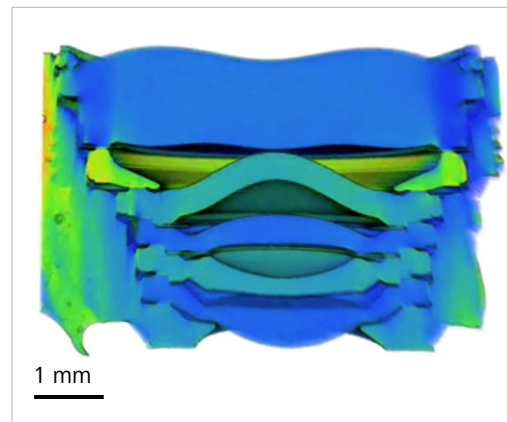

*Image intact devices such as the mobile phone camera above to see inside without destroying your sample*

# Your Flexible Choice of Components

- › In Brief
- › The Advantages
- › The Applications
- › **The System**
- › Technology and Details
- › Service

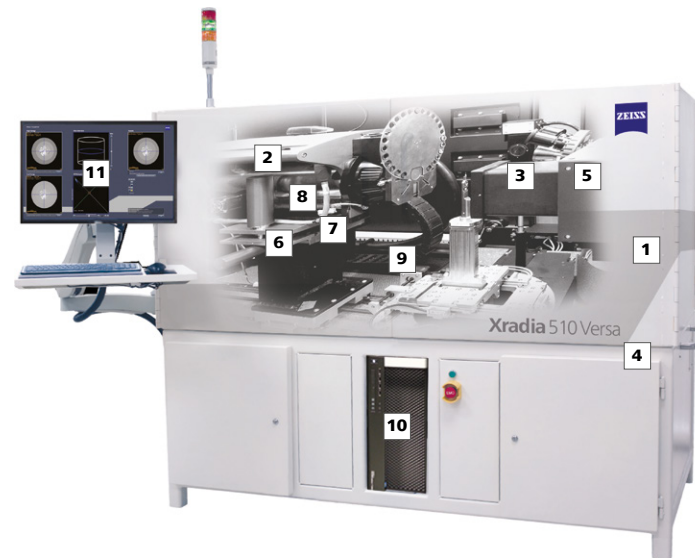

## 1 X-ray Microscope

- ZEISS Xradia 510 Versa with Resolution at a Distance (RaaD)

## 2 X-ray Source

- High performance, sealed transmission source (30 – 160 kV, Maximum 10 W)

## 3 Contrast-optimized Detectors

- Innovative dual-stage detector system with detector turret of multiple objectives at different magnifications with optimized scintillators for highest contrast
- 2k x 2k pixel noise suppressed charge-coupled detector
- 3k x 2k pixel large FOV FPX detector (optional)

## 4 System Stability for Highest Resolution

- Granite base vibrational isolation
- Thermal environment stabilization
- Proprietary stabilization mechanisms

## 5 System Flexibility for Diverse Range of Sample Sizes

- Variable scanning geometry
- Tunable voxel sizes
- Absorption contrast mode
- Phase contrast mode
- Wide Field Mode (WFM) for increased lateral tomography volume with 0.4X objective
- Vertical stitching for joining multiple tomographies vertically

## 6 Autoloader Option

- Maximize productivity by reducing user intervention
- Programmable handling of up to 14 samples
- Automated workflows for high volume, repetitive scanning

## 7 Sample Stage

- Ultra-high precision 4-degrees of freedom sample stage
- 25 kg sample mass capacity

## 8 X-ray Filters

- Single filter holder with a set of 12 filters
- Custom filters available by special order

## 9 In Situ and 4D Solutions

- RaaD enables superior *in situ* imaging
- Integrated *in situ* recipe control for Deben stages
- *In situ* interface kit option
- Custom *in situ* flow interface kit by special order

## 10 Instrument Workstation

- Power workstation with fast reconstruction
- Single CUDA-based GPU
- Multi-core CPU
- 24" display monitor

## 11 Advanced Reconstruction Toolbox with Options for Enhanced Performance

- ZEISS DeepRecon Pro with AI-based reconstruction technology for up to 10x throughput or superior image quality on Unique, Semi-repetitive, and Repetitive sample workflows
- ZEISS OptiRecon with iterative reconstruction for up to 4x throughput or enhanced image quality
- ZEISS PhaseEvolve for enhanced contrast and segmentation in low-medium density sample or high resolution imaging applications

## 12 Software

- Acquisition: Scout-and-Scan Control System with SmartShield
- Reconstruction: XMReconstructor
- Viewer: XM3DViewer
- XRM Python API to expand instrument capabilities
- Compatible with wide breadth of 3D viewers and analysis software programs
- ORS Dragonfly Pro for 3D visualization and analysis (optional)

# Technical Specifications

- › In Brief
- › The Advantages
- › The Applications
- › The System
- › **Technology and Details**
- › Service

Imaging	ZEISS Xradia 410 Versa	ZEISS Xradia 510 Versa	ZEISS Xradia 610 Versa	ZEISS Xradia 620 Versa
Spatial Resolution <sup>[a]</sup>	0.9 µm	0.7 µm	0.5 µm	0.5 µm
Resolution at a Distance (RaaD) <sup>[a,b]</sup> (at 50 mm working distance)	1.5 µm	1.0 µm	1.0 µm	1.0 µm
Minimum Achievable Voxel <sup>[c]</sup> (Voxel size at sample at maximum magnification)	100 nm	70 nm	40 nm	40 nm
<b>X-ray Source</b>				
Architecture	Sealed Reflection	Sealed Transmission	Sealed Transmission, Fast Activation	Sealed Transmission, Fast Activation
Voltage Range	20- 90 kV, 40-150 kV (Optional)	30 – 160 kV	30 – 160 kV	30 – 160 kV
Maximum Output	8 W, 10 W/30 W (Optional)	10 W	25 W	25 W
<b>Detector System</b>				
ZEISS X-ray microscopes feature an innovative detector turret with multiple objectives at different magnifications. Each objective features optimized scintillators that deliver the highest absorption contrast details.				
Standard Objectives	0.4x, 4x, 10x, 20x	0.4x, 4x, 20x	0.4x, 4x, 20x	0.4x, 4x, 20x
Optional Objectives	40x	40x, Flat Panel Extension (FPX)	40x, Flat Panel Extension (FPX)	40x, Flat Panel Extension (FPX)
<b>Stages</b>				
Sample Stage (load capacity)	25 kg	25 kg	25 kg	25 kg
Sample Stage Travel (x, y, z)	50, 100, 50 mm	50, 100, 50 mm	50, 100, 50 mm	50, 100, 50 mm
Sample Size Limit	300 mm diameter	300 mm diameter	300 mm diameter	300 mm diameter

[a] Spatial resolution measured with ZEISS Xradia 2D resolution target, normal field mode, optional 40x objective.

[b] RaaD working distance defined as clearance around axis of rotation.

[c] Voxel is a geometric term that contributes to but does not determine resolution, and is provided here only for comparison. ZEISS specifies resolution via spatial resolution, the true overall measurement of instrument resolution.

# Technical Specifications

- › In Brief
- › The Advantages
- › The Applications
- › The System
- › **Technology and Details**
- › Service

Features	ZEISS Xradia 410 Versa	ZEISS Xradia 510 Versa	ZEISS Xradia 610 Versa	ZEISS Xradia 620 Versa
Scout-and-Scan Control System	■	■	■	■
Scout-and-Zoom	■	■	■	■
Vertical Stitch	■	■	■	■
XRM Python API	■	■	■	■
Automated Filter Changer (AFC)				■
High Aspect Ratio Tomography (HART)				■
Dual Scan Contrast Visualizer (DSCoVer)				■
ZEISS LabDCT for Diffraction Contrast Tomography				Optional
Wide Field Mode	0.4x	0.4x	0.4x	0.4x and 4x
GPU CUDA-based Reconstruction	Single	Single	Dual	Dual
ZEISS SmartShield		■	■	■
ZEISS Autoloader	Optional	Optional	Optional	Optional
<i>In Situ</i> Interface Kit	Optional	Optional	Optional	Optional
ZEISS OptiRecon	Optional	Optional	Optional	Optional
ZEISS DeepRecon Pro	Optional	Optional	Optional	Optional
ZEISS PhaseEvolve	Optional	Optional	Optional	Optional
ZEISS ZEN Intellesis	Optional	Optional	Optional	Optional
ORS Dragonfly Pro	Optional	Optional	Optional	Optional
ZEISS Metrology Extension (MTX)				Optional

# ZEISS Customer Focus: Continuous Improvement and Upgradeability

- › In Brief
- › The Advantages
- › The Applications
- › The System
- › Technology and Details
- › **Service**

**Protect Your Investment. ZEISS Xradia 3D X-ray systems deliver unprecedented extensibility. ZEISS offers unrelenting support to ensure you are not left behind.**

Most ZEISS Xradia X-ray microscopes are designed to be upgradeable and extensible with future innovations and developments so that your initial investment is protected. This ensures your microscope capabilities evolve with advancements in leading technology. This is one of the key differentiators in the 3D X-ray imaging industry.

From ZEISS Xradia Context microCT, to ZEISS Xradia 510/520 Versa, and up to ZEISS Xradia 610/620 Versa, you can field-convert your system to the latest X-ray microscope products. In addition to instrument conversions at your facility, new modules are being continuously developed that will enhance your instrument to provide advanced capabilities such as *in situ* sample environments, unique imaging modalities, and productivity-enhancing modules. Also, periodic major software releases include important new features that are made available to existing instruments, thereby enhancing and extending the capabilities of your research.

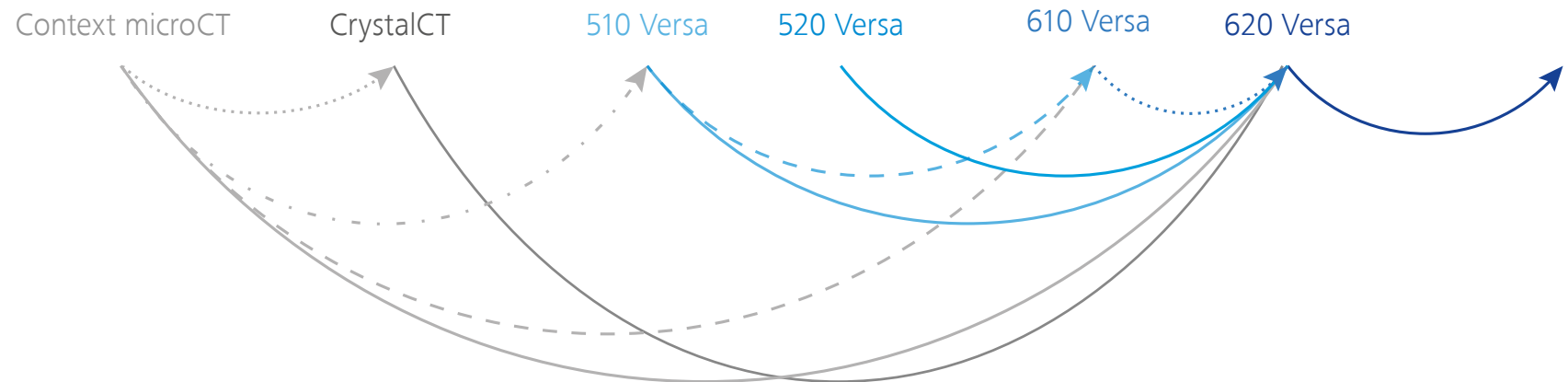





**Carl Zeiss Microscopy GmbH**  
07745 Jena, Germany  
microscopy@zeiss.com  
www.zeiss.com/510-versa