

# Quality made simple. With AI by ZEISS.

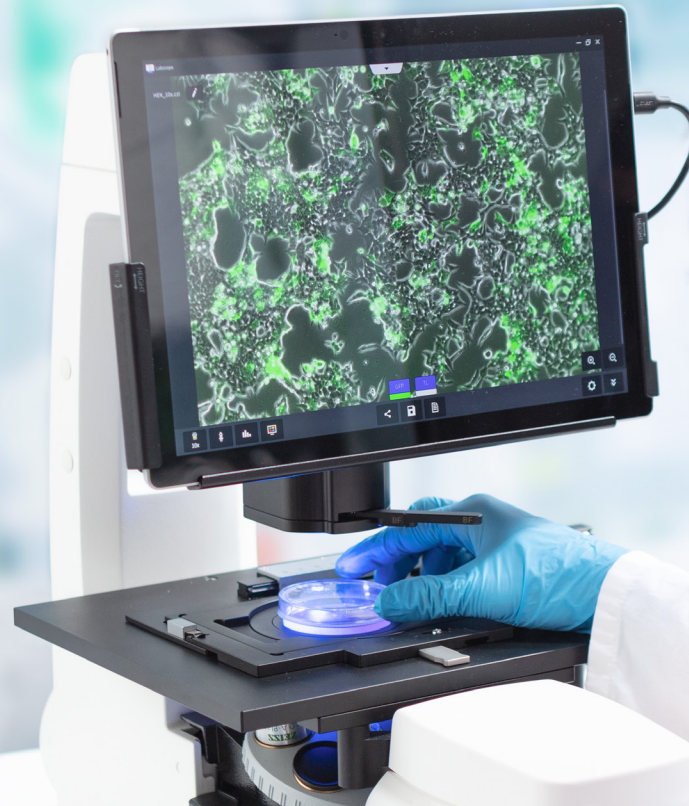

## **ZEISS Axiovert 5 digital**

Your All-in-One Cell Imaging System.

[zeiss.com/axiovert-digital](https://zeiss.com/axiovert-digital)



Seeing beyond

# Your All-in-One Cell Imaging System.

- › **In Brief**
- › The Advantages
- › The Applications
- › The System
- › Technology and Details
- › Service

Artificial Intelligence (AI) is already helping us with our daily lives, from automated driving and home assistants to securing smartphones with facial recognition. It's about time you bring AI into your cell lab, too. Axiovert 5 digital uses AI and automatic functions to ease your daily work. It will make your processes more efficient and your results more reproducible. Stay relaxed, even when there is a lot going on around you.

With Axiovert 5 digital, the AI is pre-trained, drawing on all of our vast experience at ZEISS: We have imported a huge number of datasets and that makes it particularly reliable. Just push a single button and your results will appear in real time.

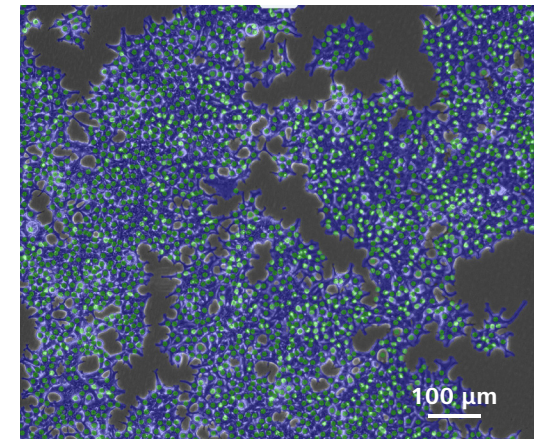

# Simpler. More Intelligent. More Integrated.

- › In Brief
- › **The Advantages**
- › The Applications
- › The System
- › Technology and Details
- › Service

## Work outside the box.

Experience the full advantages of an all-in-one microscope system. From scientific routine to basic research, phase contrast to multichannel fluorescence imaging, even novice users are guaranteed to produce brilliant images with Axiovert 5 digital. All you have to do is turn on your system and focus your sample. Don't worry about settings or adjustments – they're already done automatically. And don't be afraid of how your cells are getting along in a closed box. You will always have an eye on them. Axiovert 5 digital will define new levels of reproducibility and data quality. You can always rely on the optimal performance of your instrument to produce publication-ready images.

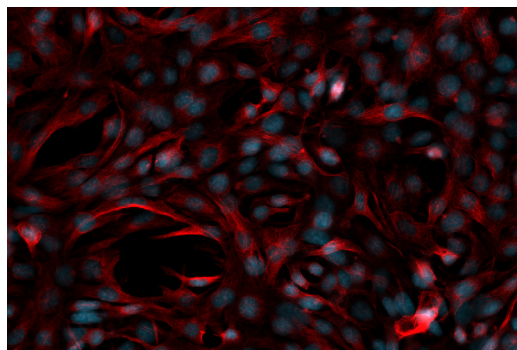

## Save time and let AI do the work.

With Axiovert 5 digital it's this easy to save time — time that could be crucial to the vitality of your cells. Save time setting up the system, time setting up acquisition parameters, time training new colleagues, time acquiring images—and time going from images to results. Axiovert 5 digital uses artificial intelligence to optimally support daily workflows. Cell counting and cell confluency are automatically determined by readily available AI modules. AI is now accessible to everyone in your lab: no training or pre-knowledge required. Results are available instantly with just one click and they are absolutely reproducible. Relax and enjoy watching AI do the work for you.

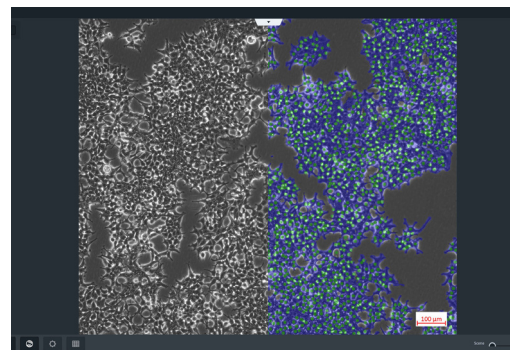

## Simply made for you.

Axiovert 5 digital is your perfect fit for multi-user environments as proper system operation is supported by design. This all-in-one imaging system comes with an intuitive operating concept. One push on the Snap button is sufficient to trigger

- image acquisition of up to 5 channels including multi-channel imaging
- the AI cell counting and confluency workflow, where images are acquired and instantly analyzed
- video recording

Axiovert 5 digital combines proven optical quality with simplicity and ease of use.





# Expand Your Possibilities

- › In Brief
- › **The Advantages**
- › The Applications
- › The System
- › Technology and Details
- › Service

## **Axiovert 5 digital works right out of the box**

You'll quickly learn to love Axiovert 5 digital: place the microscope on the table and get to your first image in next to no time. The system comes pre-configured and aligned. No calibration, no adjustments, no complex assembly. All you need is a tablet. And you'll be smiling when you see your first results pop up on the display.



# Expand Your Possibilities

- › In Brief
- › **The Advantages**
- › The Applications
- › The System
- › Technology and Details
- › Service

## **Make Your Cell Experiments More Reproducible. With ZEISS Labscope Modules AI Cell Confluency and AI Cell Counting.**

If you work with cell cultures such as COS-7, HeLa, LoVo or U2OS, you probably know all about tasks like determining cell confluency and counting cells. These are your critical values for further decisions on cell proliferation, viability, adapting environmental conditions, harvesting cells, starting transfections and preparing experiments. And both cell confluency and counting must work independently of shape, size and type of cell. Doing this manually can be a time-consuming, labor-intensive process with results that are error-prone and subjective.

It's time to start making your experiments more reproducible, using pre-trained artificial intelligence to analyze the number of cells and the covered cell area automatically. The ZEISS Labscope modules AI Cell Confluency and AI Cell Counting fit perfectly into your workflow. Examine your cells as usual, then simply take a picture as you move from one position to another in your cell culture vessel. The images are analyzed automatically and you will receive an instant result, visually and quantitatively.

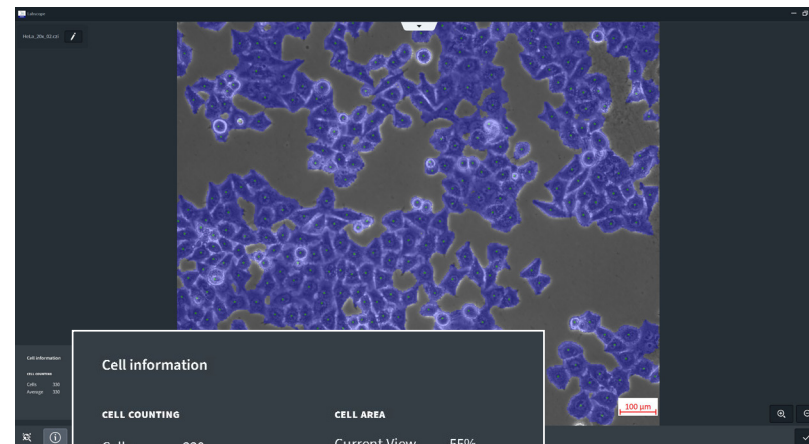
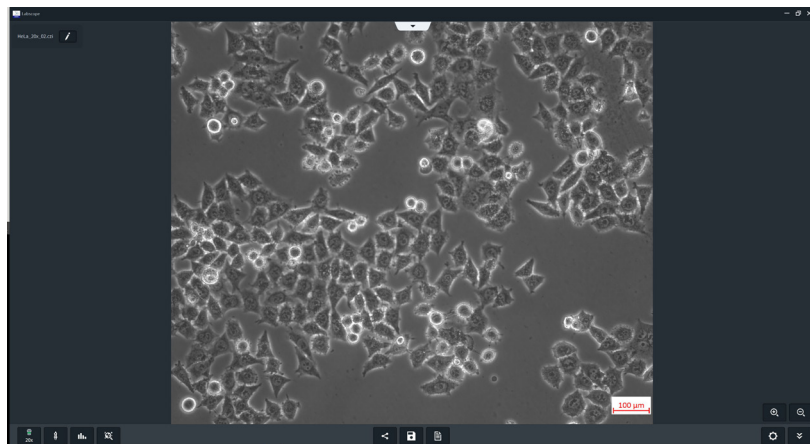

HeLa cell line, 20x objective

Left: image in phase contrast; Right: analyzed image with ZEISS Labscope

# Expand Your Possibilities

- › In Brief
- › **The Advantages**
- › The Applications
- › The System
- › Technology and Details
- › Service

## Boost your Efficiency with Smart Microscopy

Efficiency and quality are key in your lab, but it can take a lot of time to acquire multichannel fluorescence images. You know the drill: place the sample, focus on your region of interest, switch to the computer, select the channel, adjust settings, then acquire an image, insert a scale bar, switch back to the microscope ... and so on. Especially with manual microscopes this procedure can be cumbersome. Imagine, there were an easy and effortless way to acquire up to four fluorescence channels and one transmitted light channel, overlaid in one image.

With Axiovert 5 digital, you can automate your workflow and stay focused on your sample at all times—that's smart microscopy at work. The microscope automatically determines the perfect settings per channel. You get an overlaid multichannel fluorescence image with all relevant image data automatically stored in the metadata. This procedure integrates perfectly with your established microscopy workflow and boosts your efficiency tremendously.

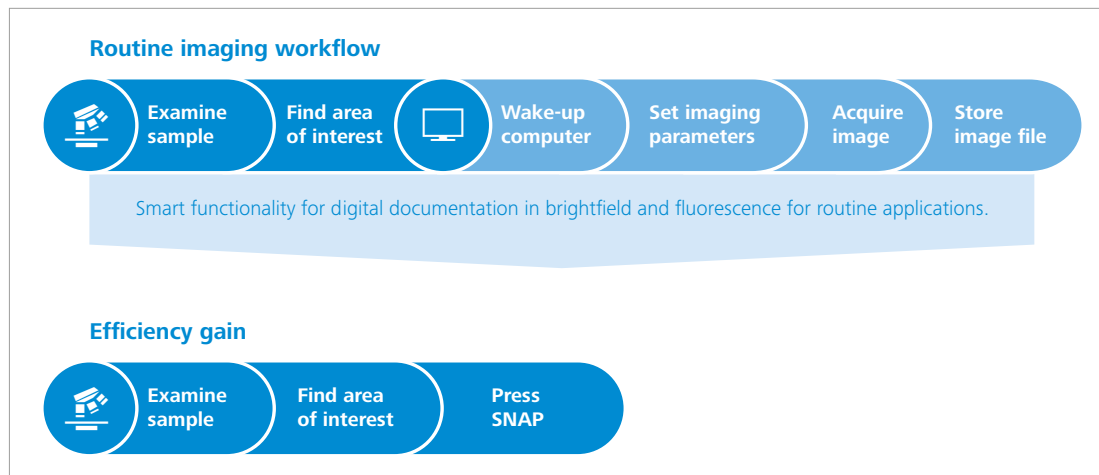

# Expand Your Possibilities

- › In Brief
- › **The Advantages**
- › The Applications
- › The System
- › Technology and Details
- › Service

## **ZEISS Labscope: Simple. Imaging. App.**

ZEISS Axiovert 5 digital is readily prepared for ZEISS Labscope, the easy-to-use imaging software. Labscope fulfills all your needs in the laboratory – from image acquisition, clever built-in measurement functions up to easy data sharing.

### **Get fast results.**

Axiovert 5 digital offers an intuitive and clearly structured user interface. All important functions and parameters are either directly visible or available within one click. You can snap images, record videos, process your imaging data, measure, annotate, and even generate reports including results.

### **Tailored precisely to your applications.**

Working in a busy lab, you need to work efficiently. Whether you acquire large images of your whole slides in brightfield, multichannel fluorescence images or observe the development of your cells: Axiovert 5 digital is the optimal choice to get fast results at the push of a button.

Opt for dedicated Labscope modules tailored exactly to your application:

- Labscope AI Cell Confluency
- Labscope AI Cell Counting
- Labscope Fast Panorama
- Labscope Multi Channel

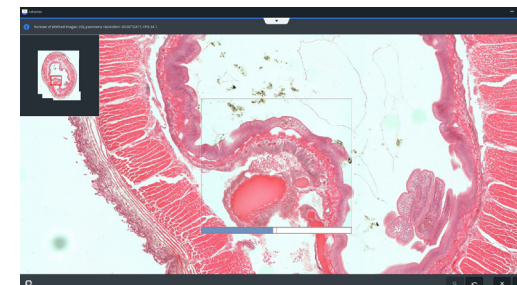
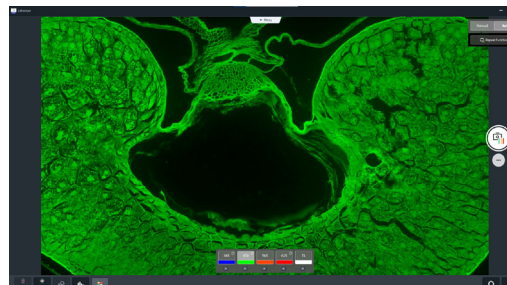
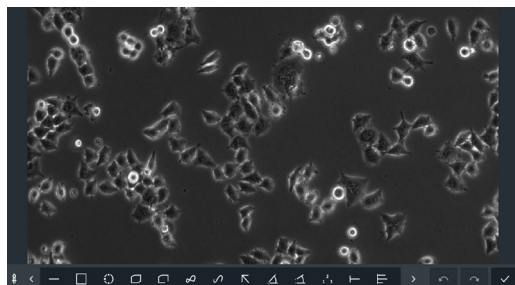

# Expand Your Possibilities

- › In Brief
- › **The Advantages**
- › The Applications
- › The System
- › Technology and Details
- › Service



*The theft protection clamp prevents unauthorized removal of the tablet.*



*The tablet position can be adjusted in height and tilting angle, independently.*



*Upgrade your system with future tablet generations.*



*Decide whether to insert or take out your tablet while working.*



*The recess at the front of the microscope is optimal to carry the microscope safely and to position it on wet lab benches.*

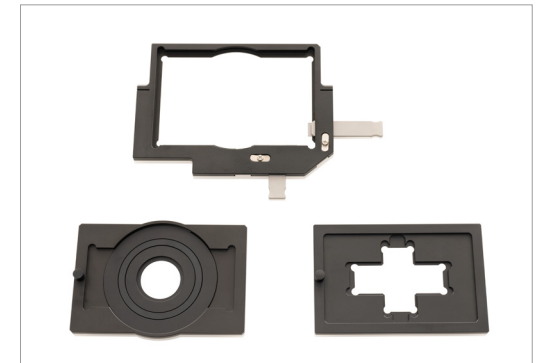

*Various stage inserts for different cell vessels are included.*



# Expand Your Possibilities

- › In Brief
- › **The Advantages**
- › The Applications
- › The System
- › Technology and Details
- › Service



*Move the contrast slider easily to switch between phase contrast and brightfield.*



*The Aquastop II protects the objectives and other optical components inside the microscope from spilled liquids.*

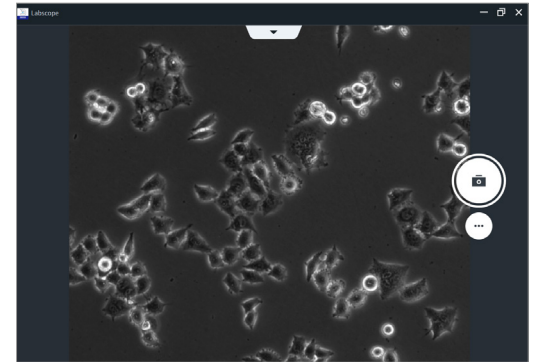

*Simply press Snap to acquire images in Labscope.*



*Get accurate data with the 6 fold encoded nosepiece turret. Also the used filterset is automatically recognized.*



*Attach the light shield to block the sample from ambient light.*

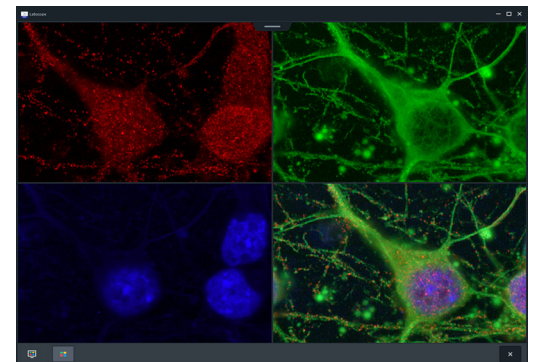

*With Axiovert 5 digital and Labscope you acquire high quality multichannel fluorescence images easily.*

# ZEISS Axiovert 5 at Work

- › In Brief
- › The Advantages
- › **The Applications**
- › The System
- › Technology and Details
- › Service

## Benefit from standard contrasting techniques for cell cultures.

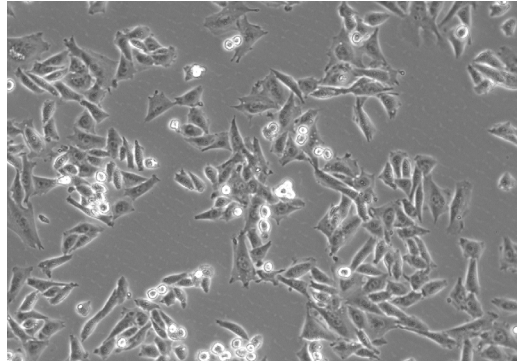

*Transmitted light phase contrast is ideal for examining thin, unstained samples like single cells.*

Almost every experiment in cell biology starts with cell culture. Whether primary cells or immortalized cell lines, the most important thing is the health and the normal behavior of the cells before starting an experiment. This makes contrast microscopy the most important control instrument in your cell culture laboratory. Axiovert 5 digital is equipped with phase contrast to get high contrast images of cells in culture. You can observe and analyze your living cells without staining. With Axiovert 5 digital this is easily accomplished with the modules Labscope AI Cell Counting and AI Cell Confluency.

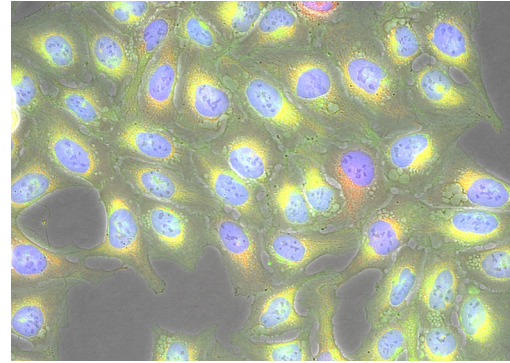

*Multichannel fluorescence: U2OS cells stained with NucBlue, CellMask green, MitoTracker Red, overlay with phase contrast*

Fluorophores and fluorescent proteins help to microscopically characterize cellular structures and metabolic processes at the single cell level and in situ. Without fluorescence microscopy, imaging-based differentiation between structures or even individual proteins would be unthinkable. Thanks to the integrated LED excitation unit of Axiovert 5 digital, you can acquire up to 4 fluorescence channels plus phase contrast in one go. The acquisition of larger data sets is possible using automated image acquisition with pre-defined light and camera settings.

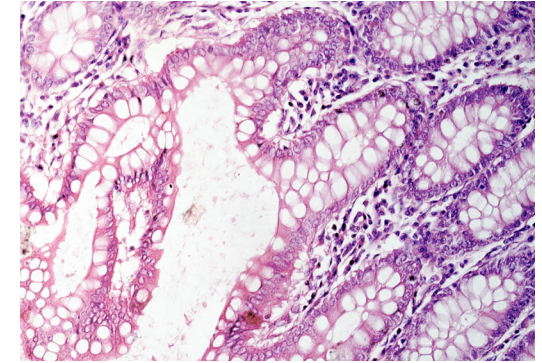

*In transmitted light brightfield you can quickly examine stained tissue sections.*

Brightfield microscopy is one of the most common microscope contrasting technique. And it is the first choice for very thin tissue sections. Since thin specimens offer little contrast, structures are hardly visible under the microscope. Various staining methods are used to differentiate tissues. Here, it is particularly important to record and reproduce structures with high contrast while being able to differentiate even slight color nuances. Axiovert 5 digital with its built-in camera provides excellent resolution and high color fidelity. You can directly evaluate and annotate images using Labscope, even in the live image.

# Your Flexible Choice of Components

- › In Brief
- › The Advantages
- › The Applications
- › **The System**
- › Technology and Details
- › Service

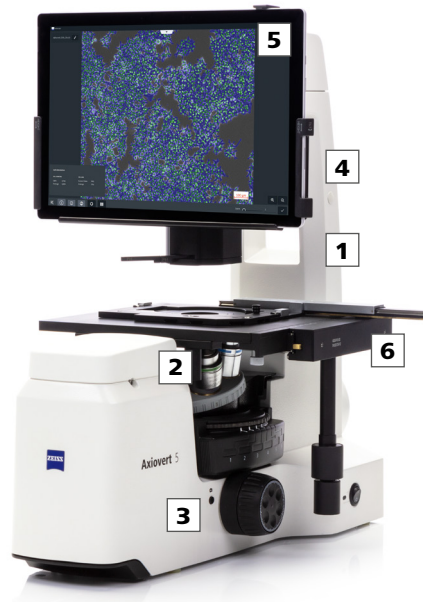

## 1 Microscope

- ZEISS Axiovert 5 digital (mono)
- ZEISS Axiovert 5 digital (color)

## 2 Objectives

- LD A-Plan 5x, 10x, 20x, 40x (all Ph objectives)

## 3 Illumination

- Transmitted light illumination with white LED 10W
- 4 solid state fluorescence LEDs

## 4 Integrated Cameras

- 5 Megapixel mono
- 5 Megapixel color

## 5 Software

- ZEISS Labscope
- Recommended optional modules
  - ZEISS Labscope AI Cell Confluency
  - ZEISS Labscope AI Cell Counting
  - ZEISS Labscope Fast Panorama
  - ZEISS Labscope Multi Channel

## 6 Accessories

- Specimen stage 232 × 230 with object guide and for mounting frame inserts
- Optional: further objectives and filter sets, Aqua Stop II

# System Overview

- › In Brief
- › The Advantages
- › The Applications
- › **The System**
- › Technology and Details
- › Service

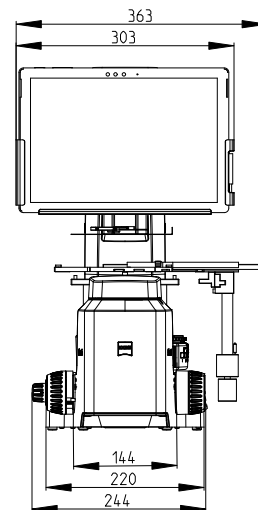
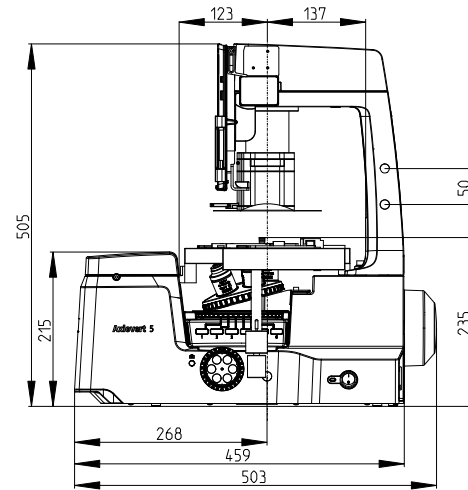

**Mounting frame insert Flex M, petridishes**  
 – for petridishes d=88 mm, 65 mm, 54 mm, 36 mm  
 – for chambers (ibidi® µ-Slide®, Nunc® Lab-Tek® / Lab-Tek® II)  
 – for insertion in Mounting frame Flex M

**Mounting frame insert Flex M, slides and chambers**  
 – for object slides 76x26 mm  
 – for chambers (ibidi® µ-Slide®, Nunc® Lab-Tek® / Lab-Tek® II)  
 – for insertion in Mounting frame Flex M

**Mounting frame Flex M**  
 – for microwell plates, flasks and petridishes d=95 mm  
 – for the mounting of Mounting frame inserts Flex M

**Object guide M 130x85**

**Aquo Stop II (optional in addition)**  
 431716-0000-000

**Specimen stage 232x230 with hardcoat anodized surface \***

**Illuminator TL LED 10 W (included with the stand)**  
 423004-9040-000

**Illumination System RGB-UV, equipped with 4 solid state LEDs**  
 – Red (625 nm)  
 – Green (565 nm)  
 – Blue (470 nm)  
 – UV (385 nm)  
 (included with the stand)

**Objective LD A-Plan 5x/0.15 Ph1 M27 \***  
**Objective LD A-Plan 10x/0.25 Ph1 M27 \***  
**Objective LD A-Plan 20x/0.35 Ph1 M27 \***  
**Objective LD A-Plan 40x/0.55 Ph1 M27 \***  
 (further objectives by choice)

**Microscope Axiovert 5 digital; integrated color camera**  
 431030-9210-000

**Microscope Axiovert 5 digital; integrated mono camera**  
 431030-9190-000

**Filter Set 90 HE LED with Reflector Module FL EC P&C \***  
 (further Filter Sets by choice)

**Dust protection set**  
 434308-9010-000  
 (included with the stand)

**Light shield to block ambient light**

**These components are included in the scope of delivery:**

- External power adaptor
- Country-specific power cable
- USB 3.0 Type C data and 60 W fast charging cable for Apple® iPad Pro® or Microsoft Surface

**The following components are not included in the scope of delivery and must be procured separately:**

- Microsoft Surface Pro 7 (CPU: i5 or above, RAM: 8 GB or above) 12.3", Microsoft Surface Pro 8 (CPU: i5 or above, RAM: 8 GB or above) 13.0", or Apple® iPad Pro® 4th Gen 12.9", or Apple® iPad Pro® 5th Gen 12.9"
- Keyboard
- Mouse

\* Apple® and iPad Pro® are registered trademarks of Apple Inc. Microsoft and Microsoft Surface are trademarks of the Microsoft group. ibidi® and µ-Slide® are registered trademarks of the ibidi GmbH. Nunc® and Lab-Tek® are registered trademarks of Nunc, Inc.



# Technical Specifications

- › In Brief
- › The Advantages
- › The Applications
- › The System
- › **Technology and Details**
- › Service

<b>Weight and sizes</b>		<b>ZEISS Axiovert 5 digital</b>	
Dimensions	503 × 363 × 505 (L × W × H in mm)		
Weight	18.2 kg		
<b>Air conditioning and quality</b>			
Temperature range for operation with indicated performance (24 h per day, regardless of whether the microscope is in operation or switched off)	5 – 40 °C		
Relative humidity	< 80 % at 40 °C		
Atmospheric pressure / altitude	800 to 1060 hPa / ≤ 2000 m above sea level		
Pollution degree	2		
<b>Mains connection</b>			
Nominal AC voltage	L/N/PE 100 to 240 VAC ± 10 %		
Nominal frequency	50/60 Hz		
Max. current	1.4 A		
Rating for microscope stand	24 VDC, 5 A		
Protection Class	IP20 (IEC 60529)		
Overvoltage category	II		
<b>Integrated illumination system RGB-UV</b>			
Color	Wavelength (nm)	Excitable dyes (examples)	Average lifetime (hrs)
Red	625	Cy5, Alexa 631, TOTO-3	> 60,000
Green	565	Cy3, TRITC, DsRed	> 60,000
Blue	470	eGFP, Fluo4, FITC	> 60,000
UV	385	DAPI, Alexa 405, Hoechst 33258	> 40,000
Cyan (optional)	505	eYFP, Eosin, TOTO-1	> 60,000
Yellow (optional)	590	mCherry, Alexa 568, mPlum	> 60,000
<b>System requirements</b>		<b>ZEISS Axiovert 5 digital mono</b>	<b>ZEISS Axiovert 5 digital color</b>
Third-party components	Microsoft Surface Pro 7 12.32" *	Microsoft Surface Pro 7 12.32" *	Microsoft Surface Pro 7 12.32" *
	Microsoft Surface Pro 8 13.0" *	Microsoft Surface Pro 8 13.0" *	Microsoft Surface Pro 8 13.0" *
	Apple iPad Pro 4 <sup>th</sup> Gen 12.9"	Apple iPad Pro 4 <sup>th</sup> Gen 12.9"	Apple iPad Pro 4 <sup>th</sup> Gen 12.9"
	Apple iPad Pro 5 <sup>th</sup> Gen 12.9"	Apple iPad Pro 5 <sup>th</sup> Gen 12.9"	Apple iPad Pro 5 <sup>th</sup> Gen 12.9"

\*recommended

# Technical Specifications

- › In Brief
- › The Advantages
- › The Applications
- › The System
- › **Technology and Details**
- › Service

Model	Axiovert 5 digital mono	Axiovert 5 digital color
Camera type	Monochrome	Color
Optical system	Infinite, ICS	
Nosepiece	6x nosepiece, encoded	
Focus	Manual coarse/fine focus; 13 mm focus range with adjustable focus stop	
Camera specification	High sensitivity 5 MP global shutter CMOS sensor, 3.45 micrometer pixel size	
Objectives (included)	LD A-Plan 5x, 10x, 20x and 40x (all Ph)	
Optional objectives	Large choice of long distance and coverslip-corrected objectives	
Contrast methods	Brightfield, phase contrast, fluorescence contrast	
Transmitted light illumination	White 10 W LED, average lifetime > 60,000 h	
Phosphorescence block filter	Fixed; prevents signal background in fluorescence imaging while allowing transmitted light contrasts	
Condenser	LD condenser 0.4 NA, WD = 53 mm	
Snap / Workflow button on stand	Ergonomically positioned on both sides of the stand; allows to snap images, record videos, start workflows	
Reflector turret	6x reflector turret, encoded; suitable for multi-bandpass and single-bandpass fluorescence filter sets; quadruple fluorescence filter set already included	
Fluorescence illumination (included)	4 fluorescence LEDs: 385 nm, 470 nm, 565 nm, 625 nm	
Fluorescence illumination (optional)	505 nm and 590 nm LED modules; can replace 565 nm and 625 nm module respectively	
Light shield to block ambient light	Mountable to condenser via magnet; allows for improved fluorescence imaging in ambient light	
Stage	Specimen stage 232x230 with hardcoat anodized surface and object guide M 130x85, mountable left and right	
Stage inserts included (further inserts are available)	Flexible mounting frame and inserts for: multiwell plates, flasks and petri dishes d=95 mm, 88 mm, 65 mm, 54 mm, 36 mm; object slides 76x26 mm and chambers (ibidi® µ-Slide®, Nunc® Lab-Tek® / Lab-Tek II)	
Imaging methods (included)	Single channel, multi-channel fluorescence, extended depth of focus, video recording, time lapse	
Optional software modules*	Labscope AI Cell Confluency, Labscope AI Cell Counting, Labscope Fast Panorama	
One click solutions	Single snap, multichannel images, video recording, AI cell confluency and cell counting workflow (image acquisition incl. instant analysis)	
System software	Labscope: Easy to use imaging app for image acquisition, annotation, processing, analysis, and reporting	
Special software features	Focus indicator, over-exposure indicator, split view, up to 13 different manual annotation and measurement tools for live and acquired images	
Tablet holder	Ergonomically adjustable in height and angle (without tools); suitable to work sitting and standing; future proof design	

\*only available for Windows

## ZEISS Service – Your Partner at All Times

Your microscope system from ZEISS is one of your most important tools. For over 170 years, the ZEISS brand and our experience have stood for reliable equipment with a long life in the field of microscopy. You can count on superior service and support - before and after installation. Our skilled ZEISS service team makes sure that your microscope is always ready for use.

- › In Brief
- › The Advantages
- › The Applications
- › The System
- › Technology and Details
- › **Service**

### Procurement

- Lab Planning & Construction Site Management
- Site Inspection & Environmental Analysis
- GMP-Qualification IQ/OQ
- Installation & Handover
- IT Integration Support
- Startup Training

### Operation

- Predictive Service Remote Monitoring
- Inspection & Preventive Maintenance
  - Software Maintenance Agreements
    - Operation & Application Training
    - Expert Phone & Remote Support
  - Protect Service Agreements
    - Metrological Calibration
    - Instrument Relocation
      - Consumables
      - Repairs

### New Investment

- Decommissioning
- Trade In

### Retrofit

- Customized Engineering
- Upgrades & Modernization
- Customized Workflows via APEER



Please note: Availability of services depends on product line and location

>> [www.zeiss.com/microservice](http://www.zeiss.com/microservice)



**Carl Zeiss Microscopy GmbH**  
07745 Jena, Germany  
microscopy@zeiss.com  
www.zeiss.com/axiovert-digital