

# Creating high-resolution 3D images by structured illumination

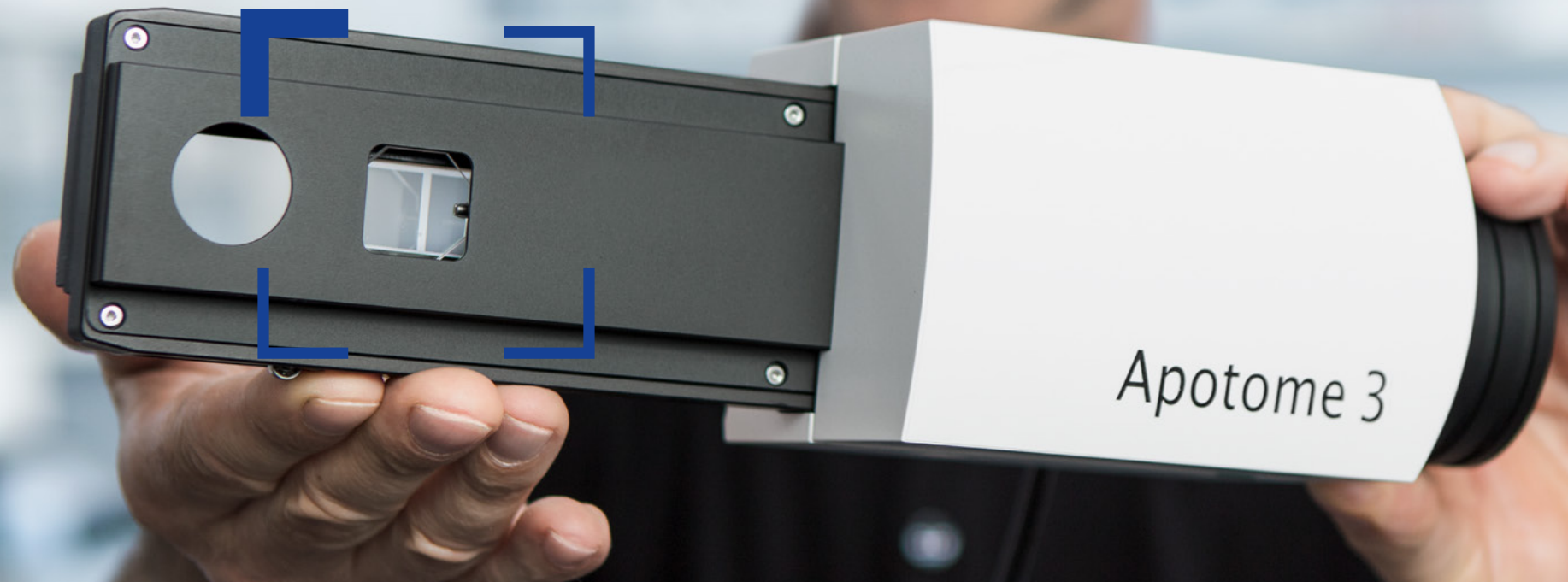

## **ZEISS Apotome 3**

Optical sectioning in fluorescence imaging for  
your widefield microscope

[zeiss.com/apotome](https://zeiss.com/apotome)



Seeing beyond

## Optical sectioning in fluorescence imaging for your widefield microscope

- › **In Brief**
- › The Advantages
- › The Applications
- › The System
- › Technology and Details
- › Service

Create high resolution optical sections of your fluorescent samples – with structured illumination, removal of out-of-focus light becomes simple and efficient, allowing you to fully focus on your research. Apotome 3 recognizes the magnification and moves the appropriate grid into the beampath. The system then calculates your optical section from a number of images with different grid positions. It's a totally reliable way to remove out-of-focus light, even in thicker specimens.

Yet your system remains just as easy to operate as always. You get images with high contrast in the best possible resolution – simply brilliant optical sections.

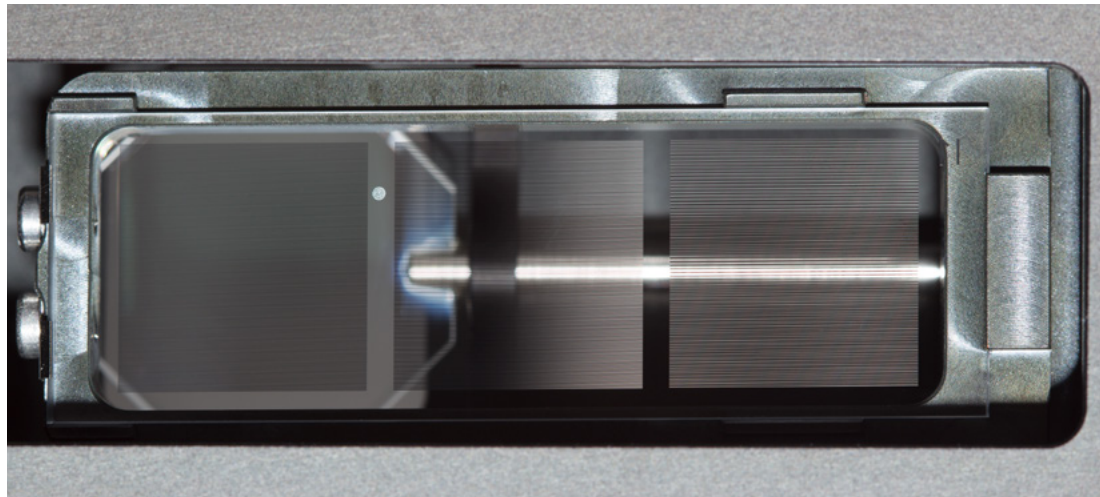

*Three different grids of Apotome 3, providing the ideal grid frequency for the selected objective.*

# Simpler. More Intelligent. More Integrated.

- › In Brief
- › **The Advantages**
- › The Applications
- › The System
- › Technology and Details
- › Service

## Brilliant optical sections with all magnifications

To image structures of sizes ranging from hundreds of micrometers to the nanometer range, you typically use objectives with different magnifications. Apotome 3 comes with three grids of different geometries, giving you the best resolution for each objective. You can fully focus on your experiment as the ideal grid is automatically selected, always resulting in high-contrast optical sections. Apotome 3 significantly increases the axial resolution compared to conventional fluorescence microscopy: you obtain brilliant optical sections that allow 3D-rendering, even from thick specimens.



## Free choice of light source and dyes

Your experiments often evolve over time in complexity and requirements. That's why you need equipment which is not only performant but also flexible. Use Apotome 3 with conventional metal halide lamps, economic white light LEDs, or the gentle, multi-color Colibri illumination system. Simply change the filter and the system automatically moves the grid into the correct position. It's your decision, not the technology's: Whether you work with DAPI, Alexa488, Rhodamin, Cy5, or with vital dyes such as GFP or mCherry – Apotome 3 adapts to your fluorophores and light source, creating the sharp and brilliant images you expect.



## Gain more structural information by deconvolution

Improve the images you created with Apotome 3 even more by deconvolution, using a patented algorithm for structured illumination. While retaining all raw data, the system allows you to switch between widefield, optical section and deconvolved images for maximum flexibility and best comparability. The fast and robust deconvolution algorithms are easy to use and improve both lateral and axial resolution of your images. Thanks to the improved contrast, higher optical resolution and suppression of existing noise, you can better recognize the structure of the examined objects.

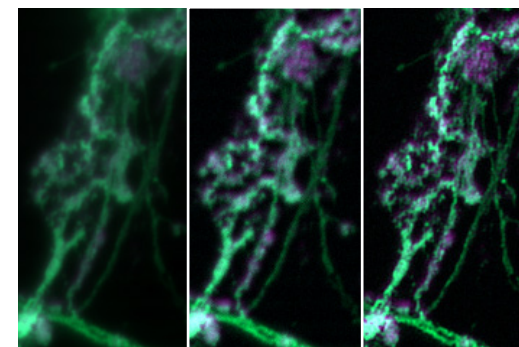

Cortical neurons (left: widefield, center: Apotome 3, right: Apotome 3 + Deconvolution). Courtesy of L. Behrendt, Leibniz-Institute on Aging – Fritz-Lipmann-Institut e.V. (FLI), Germany.

# Optimal section volume for your sample

- › In Brief
- › **The Advantages**
- › The Applications
- › The System
- › Technology and Details
- › Service

## Figure A: Acquisition with conventional epifluorescence illumination

Emission light from areas outside of the focal plane is detected by your camera. Contrast and resolution are reduced, depending on the thickness or the volume of the specimen.

## Figures B–D: Optical sections with different thickness

No matter which magnification you are using – Apotome 3 automatically places the optimum grid in the beampath of your microscope. Reduction of unwanted background fluorescence increases with the grid frequency and the optical sections become thinner.

Image information from outside of the focal plane is suppressed (Fig. B, C and D). This improves contrast and resolution of the optical section. “Low grid” delivers the optimal section thickness in our example (Fig. D). Images of this type are particularly suitable for 3D analyses and the processing of your image data with rendering software.

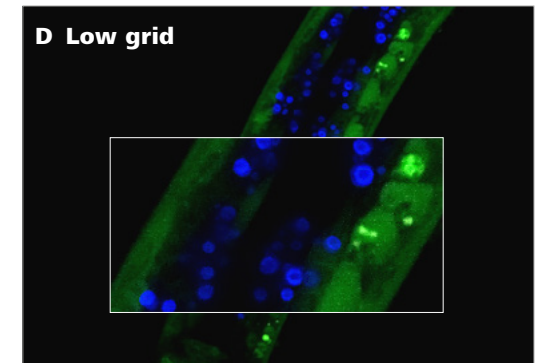
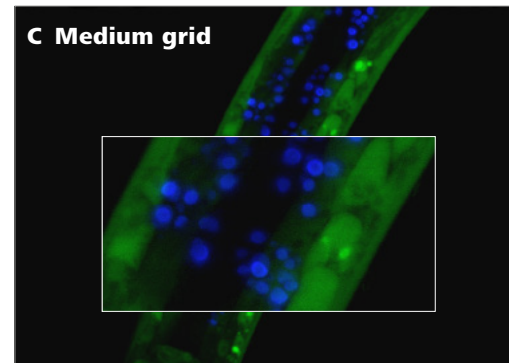
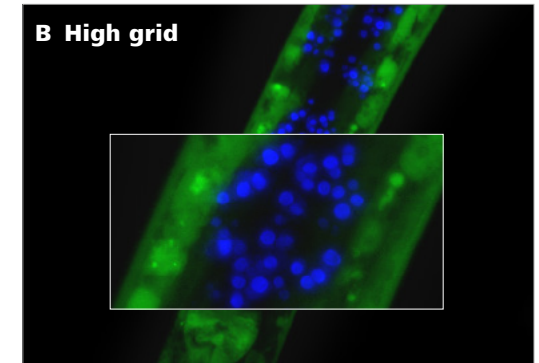
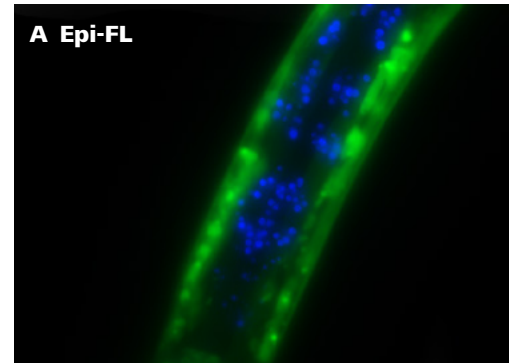

*C. elegans*, whole mount, green: GFP, blue: DAPI  
Objective: Plan-Apochromat 20×/0.8  
Courtesy of Prof. Schnabel, T.U. Braunschweig, Germany

## Your Insight into the Technology Behind It

- › In Brief
- › **The Advantages**
- › The Applications
- › The System
- › Technology and Details
- › Service

### **ZEISS Apotome 3 brings you optical sectioning**

Apotome 3 projects a grid structure into the focal plane of your specimen, then moves it into different positions using a scanning mechanism. At each grid position, Apotome 3 automatically acquires a digital image. The system processes all images into one optical section with improved contrast and increased resolution using a patented algorithm. The resulting image is free from grid structures.

### **ZEISS Apotome 3 grid in the beampath**

Fluorescence excitation light passes through two glass plates in the Apotome 3 slider. When a grid structure is applied to the first glass plate, the grid pattern is "imprinted" in the excitation light. A scanning mechanism tilts the second glass plate and the image of the grid is laterally shifted in the focal plane of the specimen.

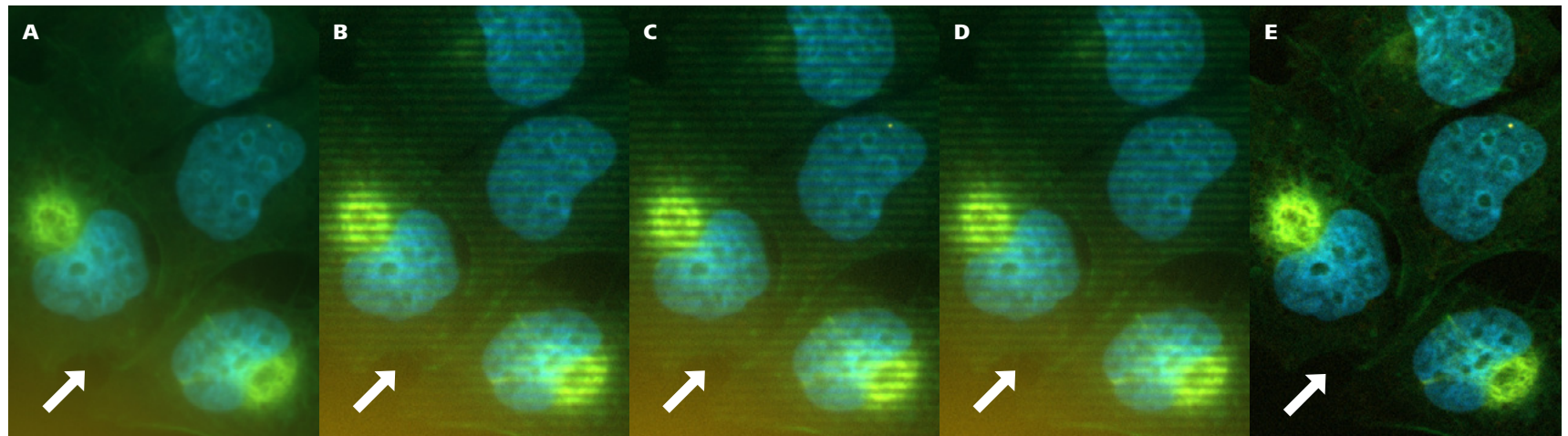

*Schematic illustration of the grid projection. A: Widefield image. B – D: raw images with different positions of the grid. E: resulting optical section through the sample. Out of focus light is efficiently removed by the structured illumination (arrow).*

# Tailored Precisely to Your Applications

- › In Brief
- › The Advantages
- › **The Applications**
- › The System
- › Technology and Details
- › Service

Apotome 3 is the cost-effective solution for creating optical sections with high contrast. Use this to your advantage in a wide range of applications from cell culture preparations via tissue sections to whole embryos.

Typical Applications/Typical Specimens	Task	ZEISS Apotome 3 offers
Cell Culture	2D imaging	<ul style="list-style-type: none"> <li>■ 2D single images</li> </ul>
	Fast imaging of a 2D image	<ul style="list-style-type: none"> <li>■ Optical section available online on the monitor</li> </ul>
	Reliable detection of the marker even with strong background fluorescence	<ul style="list-style-type: none"> <li>■ Automatic grid selection for optimum contrast with each objective</li> </ul>
	Combination of multiple contrast techniques	<ul style="list-style-type: none"> <li>■ Any combination of fluorescence channels, brightfield, DIC and phase contrast</li> <li>■ Individual configuration of each fluorescence channel as an optical section or widefield image</li> </ul>
Live Cell Imaging	Reduction of phototoxicity	<ul style="list-style-type: none"> <li>■ Particularly low phototoxicity in combination with LED illumination and high sensitive cameras like ZEISS Axiocams</li> </ul>
	Time-lapse images	<ul style="list-style-type: none"> <li>■ Depending on the exposure time, up to three images per second</li> <li>■ Doubling of the frame rate with "burst mode"</li> </ul>
Vibratome Sections, Histological Samples	3D imaging	<ul style="list-style-type: none"> <li>■ Automatic selection of the optimum grid for each objective</li> </ul>
	Modification of the optical section thickness	<ul style="list-style-type: none"> <li>■ Grid freely selectable depending on the specimen</li> </ul>
	Penetration depth	<ul style="list-style-type: none"> <li>■ Depending on the optical density of the tissue</li> </ul>
	3D reconstruction	<ul style="list-style-type: none"> <li>■ Rendering of the image stack via integrated software function</li> <li>■ Automatic transfer of the parameters of the individual fluorescence channels</li> </ul>
	Quantitative analysis	<ul style="list-style-type: none"> <li>■ Reproducible size measurements through automatic system calibration</li> </ul>
Whole Mounts	3D imaging	<ul style="list-style-type: none"> <li>■ Multi Channel, Z Stack and Time Lapse, Deconvolution, images in raw data mode, 3D Rendering</li> </ul>
	Large image areas	<ul style="list-style-type: none"> <li>■ Automatic acquisition of large sections using Tiles &amp; Positions</li> </ul>

# ZEISS Apotome 3 at Work

- › In Brief
- › The Advantages
- › **The Applications**
- › The System
- › Technology and Details
- › Service

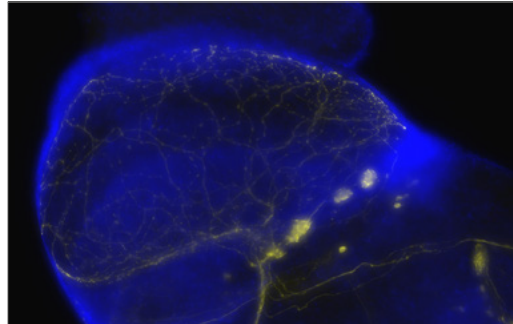

Figure A: Conventional fluorescence

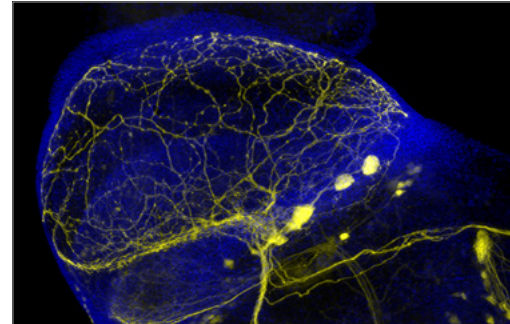

Figure B: Apotome 3

*Drosophila neurons, blue: DAPI, yellow: GFP. Objective: Plan-Apochromat 20x/0.8.*

*Courtesy of M. Koch, Molecular and Developmental Genetics, University of Leuven, Belgium*

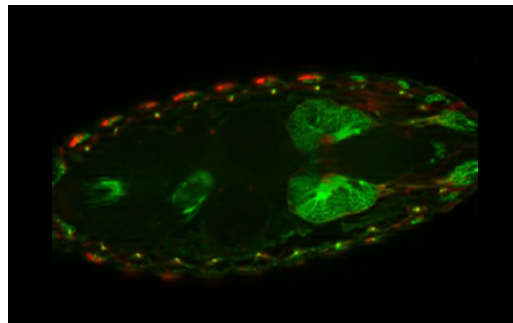

Figure C: *Drosophila embryo, green: HRP, red: glia marker, 100 µm Z-stack*

*Courtesy of C. Klämbt, Institute for Neurobiology, University of Münster, Germany*

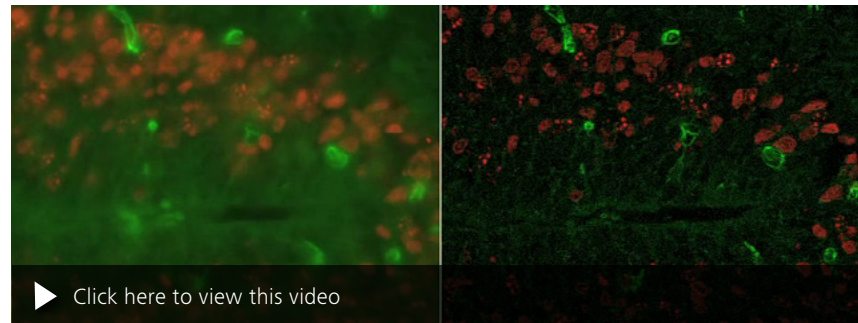

Figure D: *Mouse embryo, tissue section, green: GFP, red: Cy3*

*Objective: Plan Apochromat 40x/1.3 Oil*

*Courtesy of N. Büttner, T. Vogel, Centre for Anatomy, University of Göttingen, Germany*

# ZEISS Apotome 3 at Work

- › In Brief
- › The Advantages
- › **The Applications**
- › The System
- › Technology and Details
- › Service

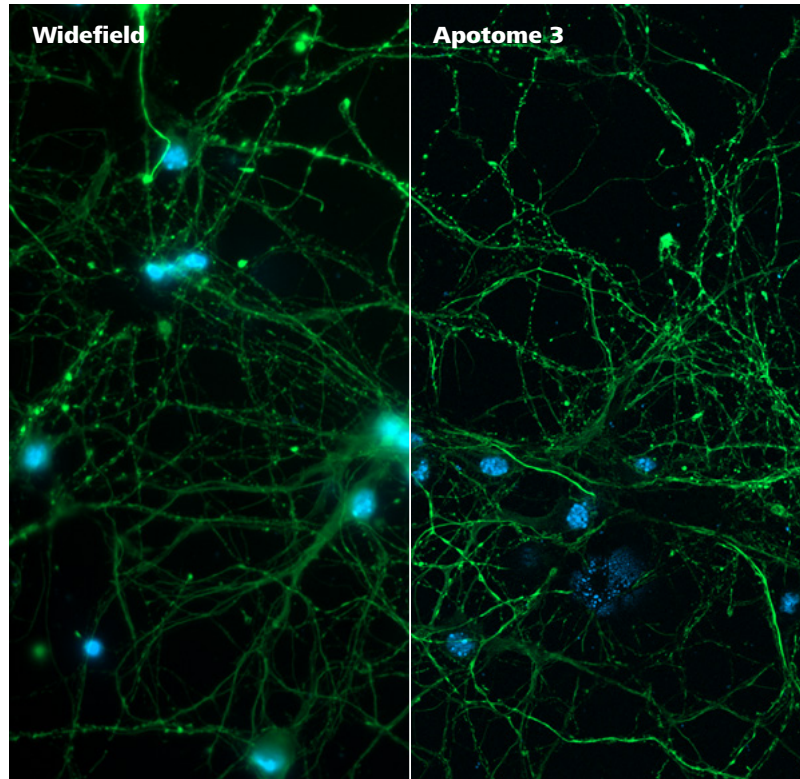

Comparison of a widefield image of cortical neurons stained for DNA and microtubules.  
Courtesy of L. Behrendt, Leibniz-Institute on Aging – Fritz-Lipmann-Institut e.V. (FLI), Germany.

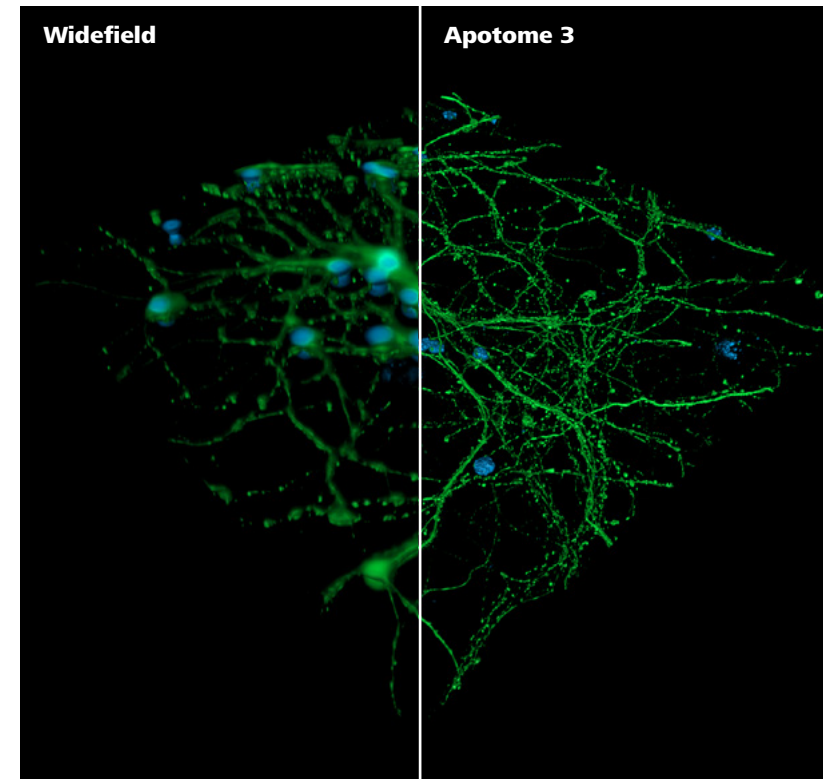

3D rendering of a section of cortical neurons stained for DNA and microtubules.  
The enhanced resolution improves the image quality significantly.  
Courtesy of L. Behrendt, Leibniz-Institute on Aging – Fritz-Lipmann-Institut e.V. (FLI), Germany.



# ZEISS Apotome 3 at Work

- › In Brief
- › The Advantages
- › **The Applications**
- › The System
- › Technology and Details
- › Service

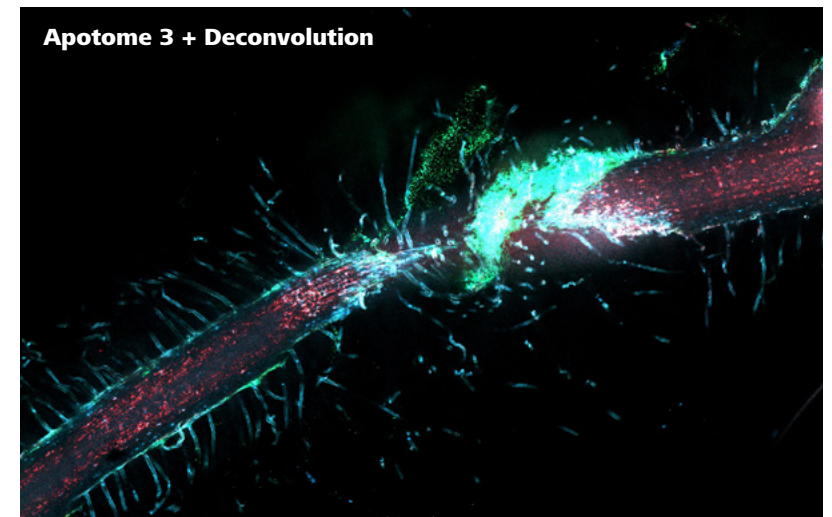
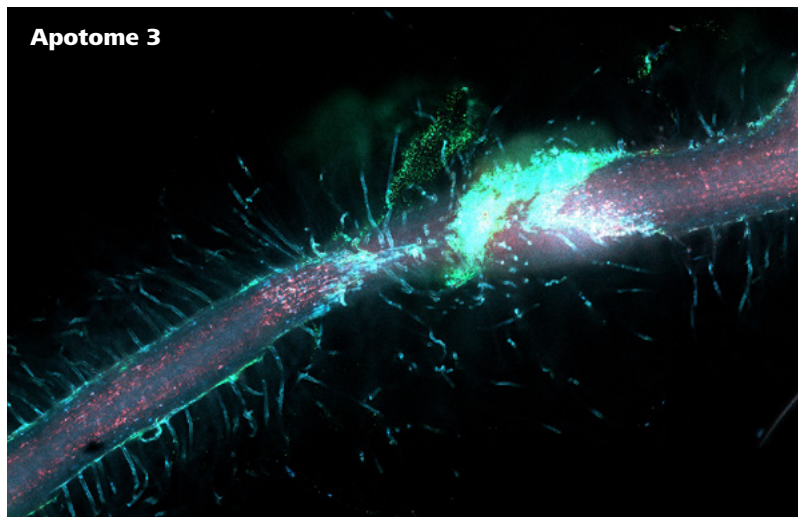
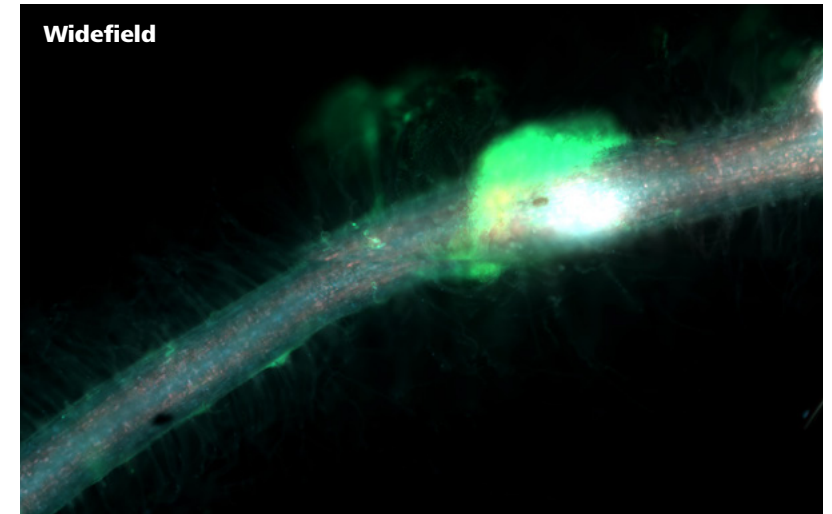
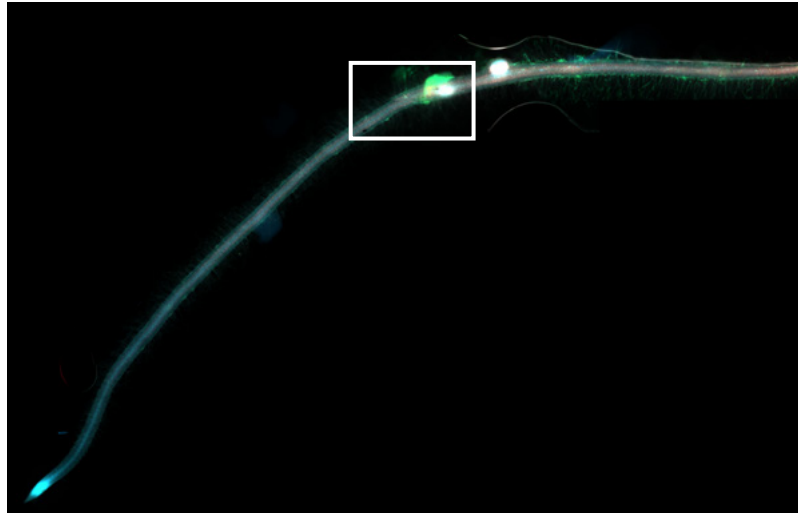

Autofluorescence of a *Lotus Japonicus* root infected with symbiotic bacteria stained with mcherry. Courtesy of F. A. Ditengou, University of Freiburg, Germany.

# ZEISS Apotome 3 at Work

- › In Brief
- › The Advantages
- › **The Applications**
- › The System
- › Technology and Details
- › Service

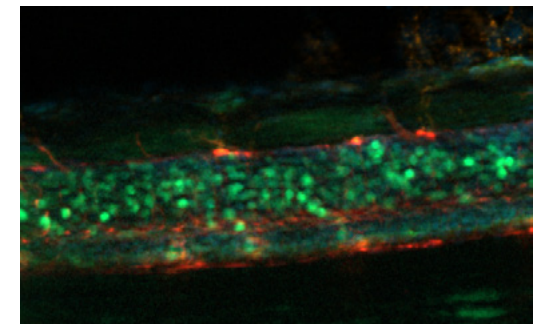
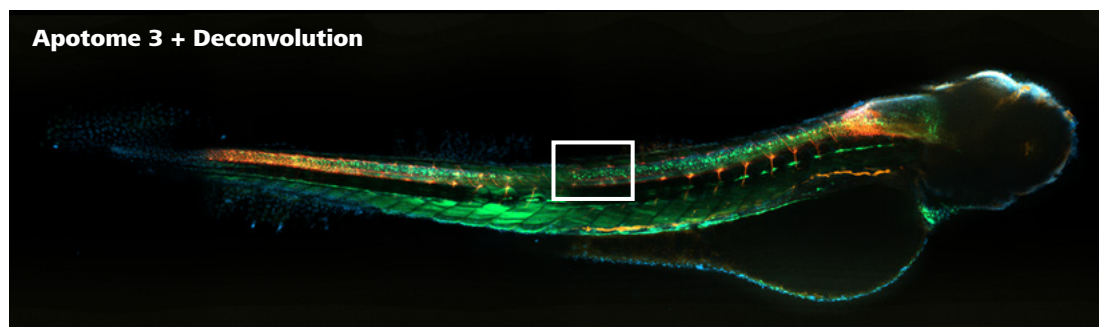
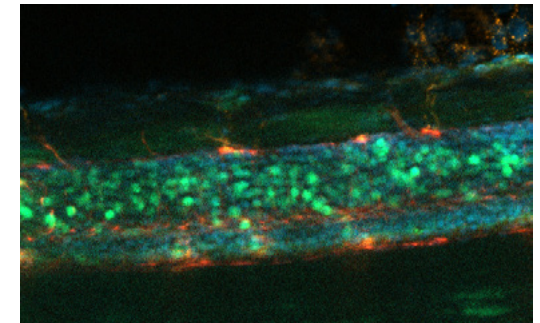
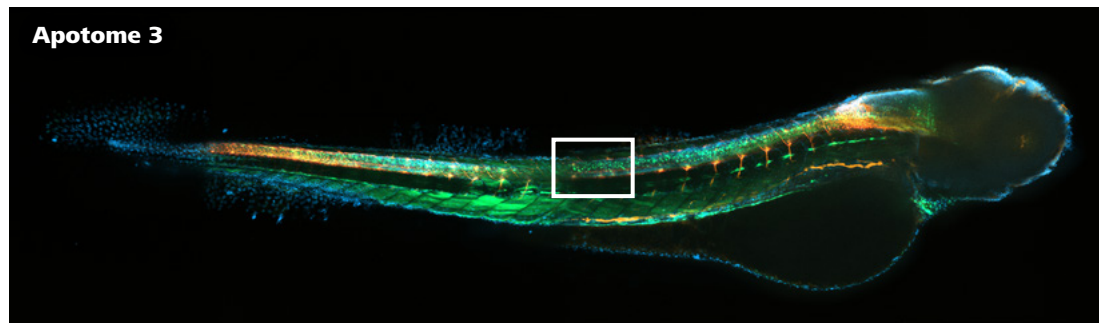
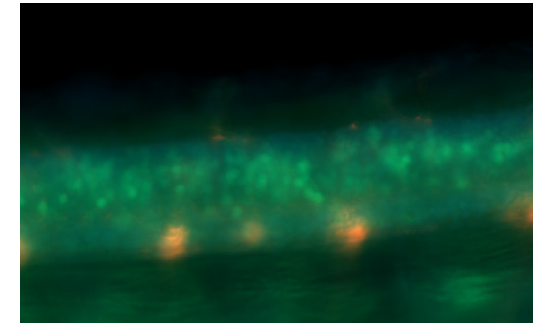
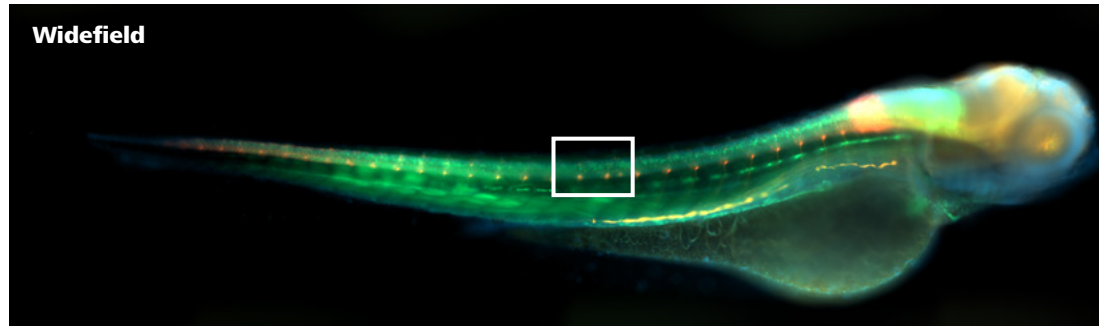

*Transgenic zebrafish larvae at 4 days post fertilization staining for: Glial fibrillary acidic protein, acetylated Tubulin, GFP and DNA. Embedded in 1.2% low melt agarose. Courtesy of H. Reuter, Leibniz-Institute on Aging – Fritz-Lipmann-Institut e.V. (FLI), Germany.*

# ZEISS Apotome 3 at Work

- › In Brief
- › The Advantages
- › **The Applications**
- › The System
- › Technology and Details
- › Service

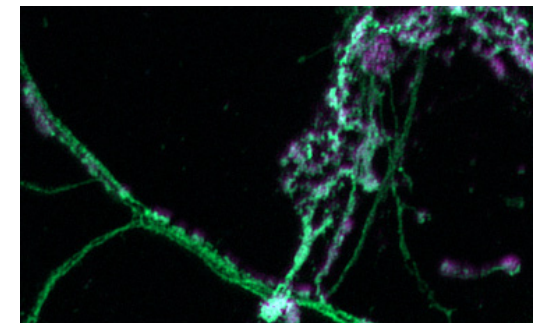
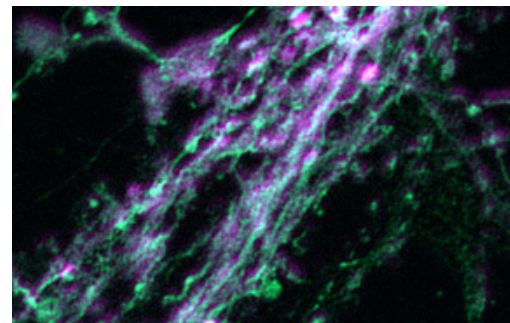
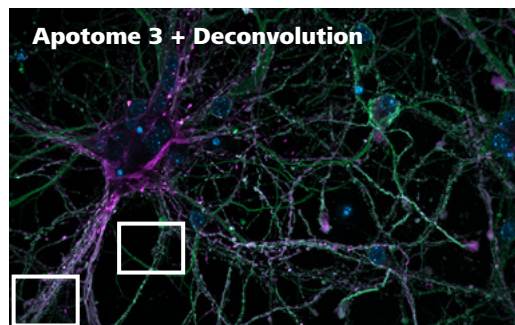
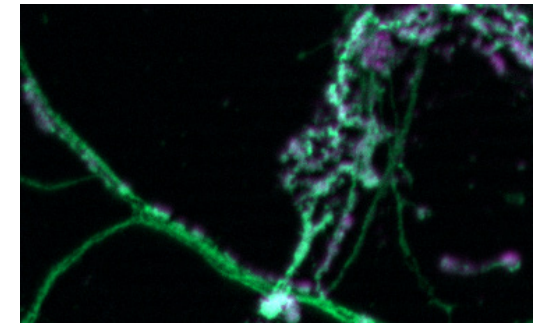
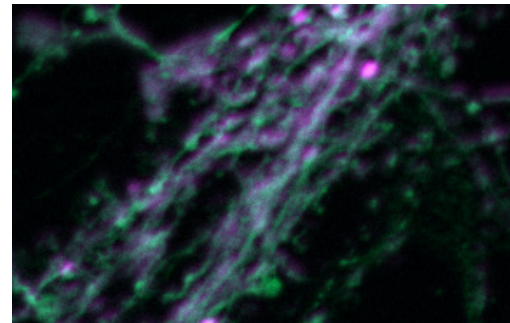
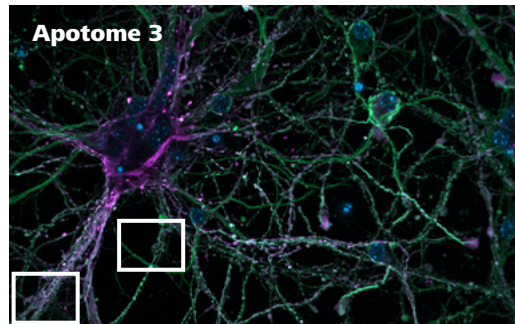
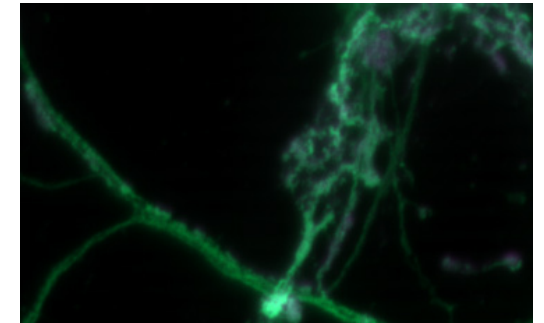
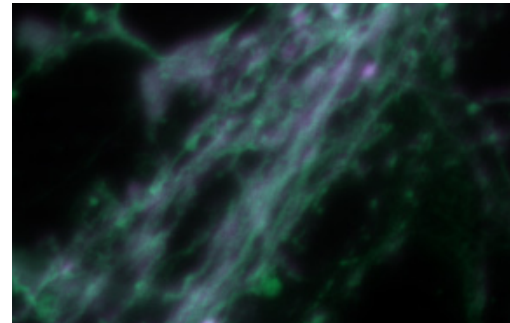
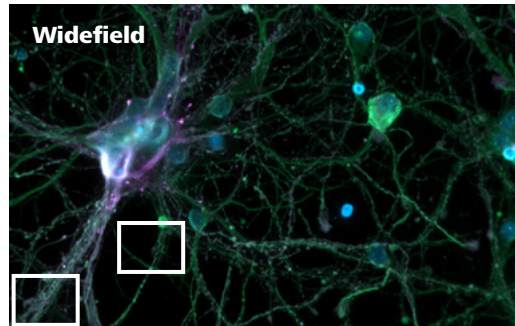

Cortical neurons stained for DNA, microtubules and microtubule-associated proteins. Courtesy of L. Behrendt, Leibniz-Institute on Aging – Fritz-Lipmann-Institut e.V. (FLI), Germany.

# Your Flexible Choice of Components

- › In Brief
- › The Advantages
- › The Applications
- › **The System**
- › Technology and Details
- › Service

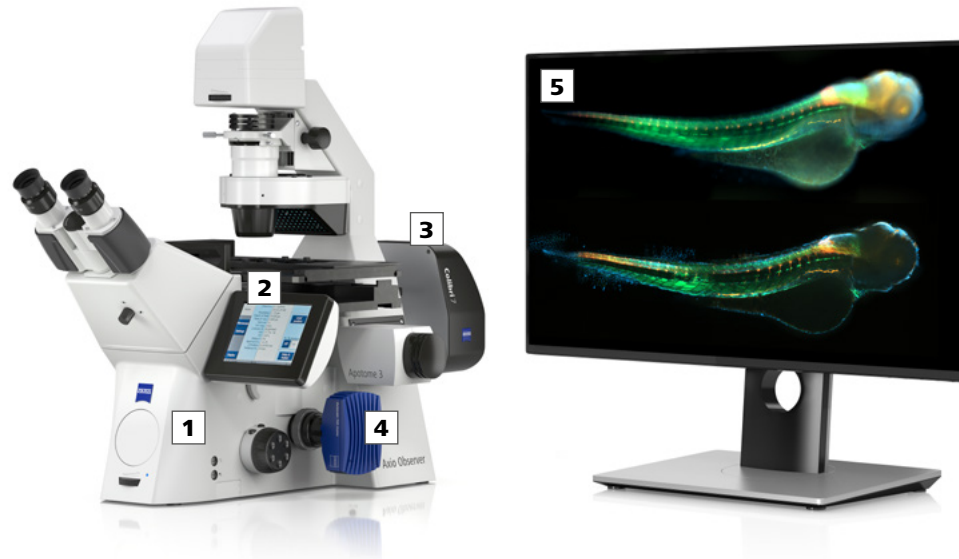

## 1 Microscope

- Axio Observer series  
(inverted research microscope)
- Axio Imager 2 series  
(upright research microscope)
- Axio Zoom.V16 (zoom microscope)
- Simple upgrading of existing systems

## 2 Objectives

Recommended objective classes with the highest level of image quality:

- C-Apochromat
- Plan-Apochromat
- EC Plan-Neofluar

## 3 Illumination

- Colibri 5 and 7 (LED)
- Xylis LED (white light LED)
- HBO (mercury vapor lamp)
- HXP 120 C (metal halide)

## 4 Cameras

- Monochrome, low noise ZEISS Axiocam camera models
- Selected 3<sup>rd</sup>-party cameras

## 5 Software

Recommended ZEN modules:

- Multi Channel, Z Stack, Time Lapse (imaging)
- Tiles & Positions (imaging with scanning table)
- Deconvolution (image processing)
- Direct Processing
- 3Dxl (rendering multidimensional image stacks)
- Image analysis modules such as Image Analysis, Colocalization

# System Overview

- › In Brief
- › The Advantages
- › The Applications
- › **The System**
- › Technology and Details
- › Service

## Apotome 3 with ZEISS Axio Observer

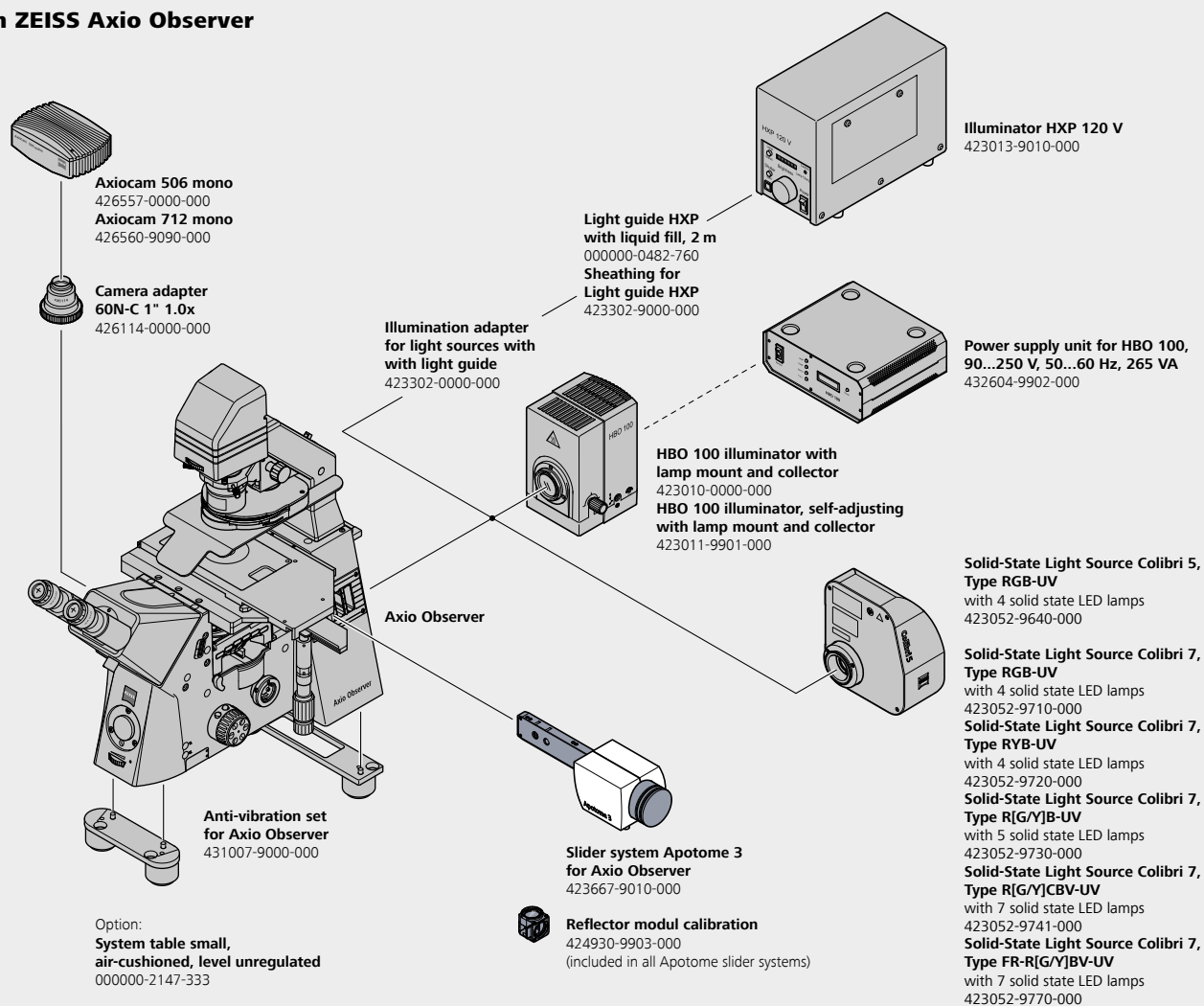

# System Overview

- › In Brief
- › The Advantages
- › The Applications
- › **The System**
- › Technology and Details
- › Service

## Apotome 3 with ZEISS Axio Imager

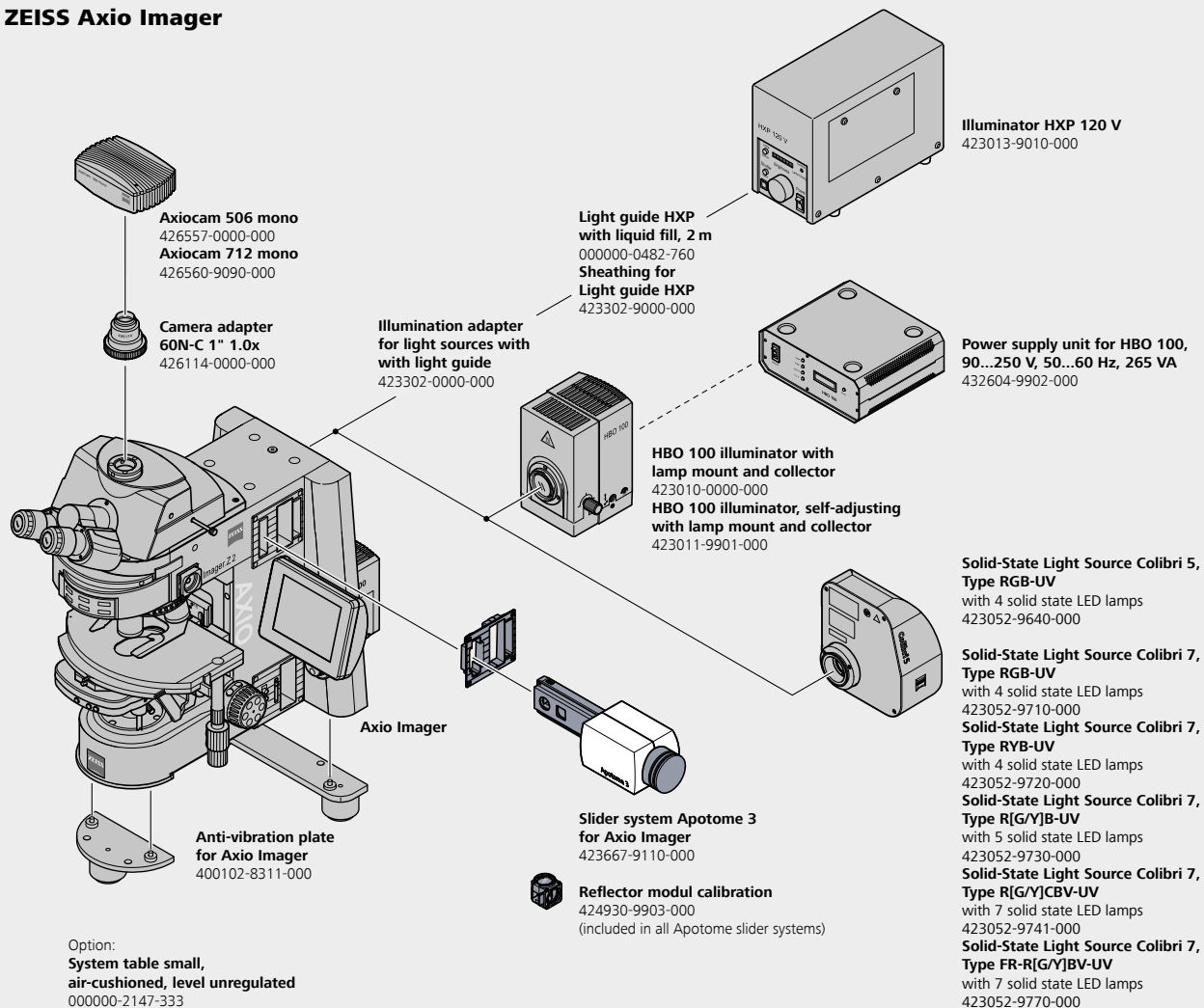

# System Overview

- › In Brief
- › The Advantages
- › The Applications
- › **The System**
- › Technology and Details
- › Service

## Apotome 3 with ZEISS Axio Zoom.V16

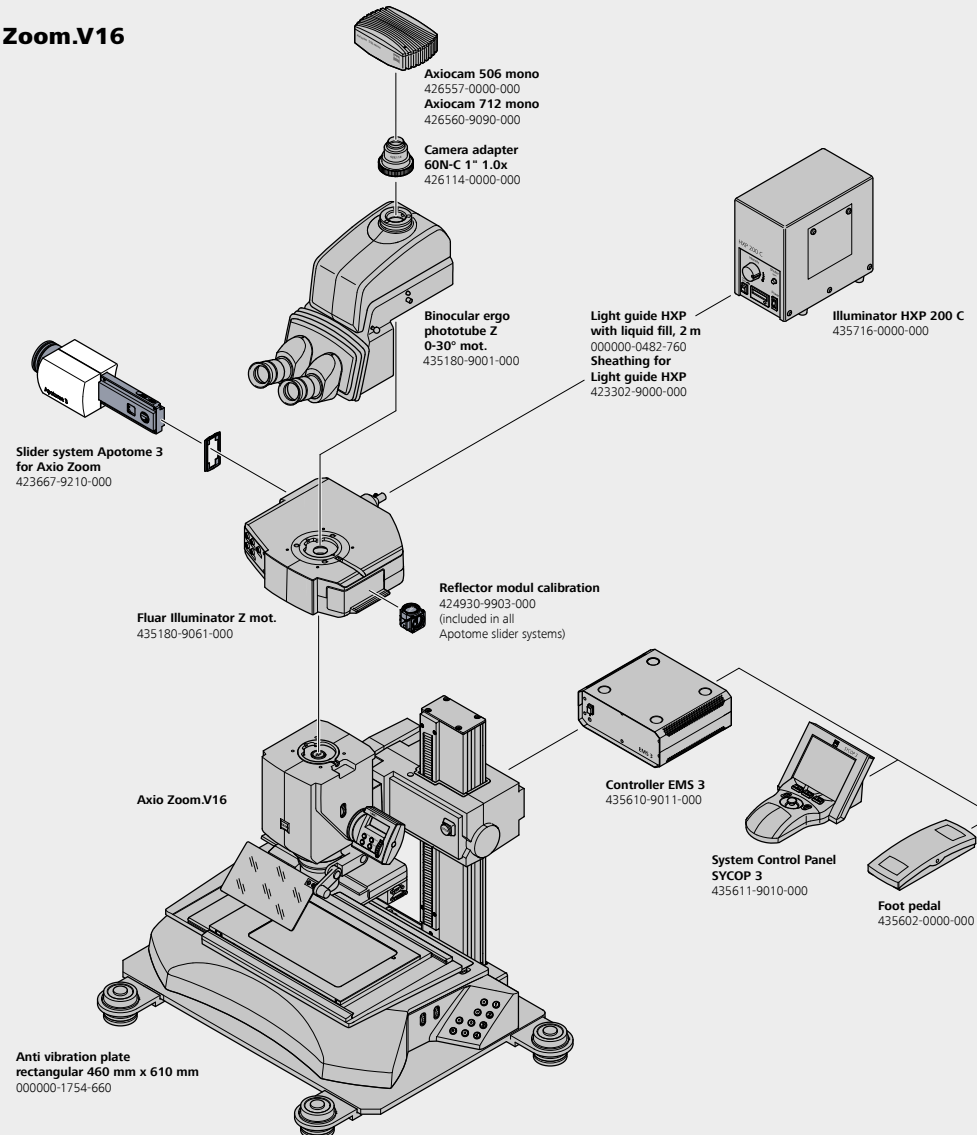

# Technical Specifications

- › In Brief
- › The Advantages
- › The Applications
- › The System
- › **Technology and Details**
- › Service

Grid Table: Apotome 3 generates optical sections of a defined thickness (in Rayleigh units, RU and microns,  $\mu\text{m}$ ) depending on wavelength, microscope and objective used.

Data for the Use of Upright Microscopes, e.g. ZEISS Axio Imager

Objectives for Axio Imager	V	NA	Immersion	Grid/Section thickness @490nm [RU/ $\mu\text{m}$ ]			DAPI with FS34	DAPI with FS49
				High grid	Medium grid	Low grid		
EC Plan-Neofluar	10x	0.3	Air	2.9/31.9	1.7/18.2	0.9/9.9	Yes	Yes
EC Plan-Neofluar	20x	0.5	Air	2.4/9.2	1.4/5.3	0.7/2.9	Yes	Yes
EC Plan-Neofluar	40x	0.75	Air	1.6/2.8	0.9/1.6	0.5/0.9	Yes	Yes
EC Plan-Neofluar	40x	1.3	Oil	2.5/2.2	1.4/1.2	0.8/0.7	Yes	Yes
EC Plan-Neofluar	63x	0.95	Air	1.0/1.1	0.6/0.7	0.4/0.4	Yes	No
EC Plan-Neofluar	63x	1.25	Oil	1.6/1.5	0.9/0.9	0.5/0.5	Yes	Yes
EC Plan-Neofluar	100x	1.3	Oil	1.0/0.9	0.6/0.5	0.4/0.3	Yes	Yes
LCI Plan-Neofluar	25x	0.8	Oil, water or glycerin	2.9/6.6	1.7/3.7	0.9/2.0	Yes	Yes
LCI Plan-Neofluar	63x	1.3	Water or glycerin	1.5/1.3	0.9/0.7	0.5/0.4	Yes	Yes
Plan-Apochromat	10x	0.45	Air	4.2/20.4	2.4/11.5	1.3/6.2	Yes	Yes
Plan-Apochromat	20x	0.8	Air	3.2/4.9	1.8/2.8	1.0/1.5	Yes	Yes
Plan-Apochromat	40x	0.95	Air	1.6/1.7	0.9/1.0	0.5/0.5	Yes	Yes
Plan-Apochromat	40x	1.3	Oil	2.5/2.2	1.4/1.2	0.8/0.7	Yes	Yes
Plan-Apochromat	40x	1.4	Oil	2.4/1.8	1.4/1.0	0.7/0.6	Yes	Yes
Plan-Apochromat	63x	1.4	Oil	1.6/1.2	0.9/0.7	0.5/0.4	Yes	Yes
Plan-Apochromat	100x	1.4	Oil	1.0/0.8	0.6/0.5	0.4/0.3	Yes	Yes
LD LCI Plan-Apochromat	25x	0.8	Oil, water or glycerin	2.9/6.6	1.7/3.7	0.9/2.0	Yes	Yes
C-Apochromat	10x	0.45	Water	4.2/20.4	2.4/11.5	1.3/6.2	Yes	Yes
C-Apochromat	40x	1.2	Water	2.2/2.0	1.2/1.1	0.7/0.6	Yes	Yes
C-Apochromat	63x	1.2	Water	1.4/1.3	0.8/0.7	0.5/0.4	Yes	Yes
LD C-Apochromat	40x	1.1	Water	2.2/2.3	1.2/1.3	0.7/0.7	Yes	Yes
Plan-Apochromat	63x	1.46	Oil	1.5/1.0	0.9/0.6	0.5/0.3	Yes	Yes
Plan-Fluar	100x	1.45	Oil	1.0/0.7	0.6/0.4	0.3/0.2	No	No
Plan-Apochromat	100x	1.46	Oil	1.0/0.7	0.6/0.4	0.3/0.2	Yes	No



# Technical Specifications

- › In Brief
- › The Advantages
- › The Applications
- › The System
- › **Technology and Details**
- › Service

Data for the Use of Inverted Microscopes, e.g. ZEISS Axio Observer

Objectives for Axio Observer	V	NA	Immersion	Grid/Section thickness @490nm [RU/μm]			DAPI with FS34	DAPI with FS49
				High grid	Medium grid	Low grid		
EC Plan-Neofluar	10×	0.3	Air	2.9/31.5	1.7/18.5	0.9/9.8	Yes	Yes
EC Plan-Neofluar	20×	0.5	Air	2.3/9.0	1.4/5.4	0.7/2.9	Yes	Yes
EC Plan-Neofluar	40×	0.75	Air	1.6/2.7	0.9/1.6	0.5/0.9	Yes	No
EC Plan-Neofluar	40×	1.3	Oil	2.4/2.1	1.4/1.3	0.8/0.7	Yes	Yes
EC Plan-Neofluar	63×	0.95	Air	1.0/1.1	0.6/0.7	0.4/0.4	Yes	Yes
EC Plan-Neofluar	63×	1.25	Oil	1.6/1.5	0.9/0.9	0.5/0.5	Yes	No
EC Plan-Neofluar	100×	1.3	Oil	1.0/0.9	0.6/0.6	0.4/0.3	Yes	No
LCI Plan-Neofluar	25×	0.8	Oil, water or glycerin	2.9/6.5	1.7/3.8	0.9/2.0	Yes	Yes
LCI Plan-Neofluar	63×	1.3	Water or glycerin	1.5/1.3	0.9/0.8	0.5/0.4	No	No
Plan-Apochromat	10×	0.45	Air	4.2/20.2	2.4/11.7	1.3/6.1	Yes	Yes
Plan-Apochromat	20×	0.8	Air	3.1/4.8	1.8/2.8	1.0/1.5	Yes	Yes
Plan-Apochromat	40×	0.95	Air	1.6/1.7	0.9/1.0	0.5/0.5	Yes	Yes
Plan-Apochromat	40×	1.3	Oil	2.4/2.2	1.4/1.3	0.8/0.7	Yes	Yes
Plan-Apochromat	40×	1.4	Oil	2.4/1.8	1.4/1.1	0.7/0.6	Yes	Yes
Plan-Apochromat	63×	1.4	Oil	1.5/1.2	0.9/0.7	0.5/0.4	Yes	Yes
Plan-Apochromat	100×	1.4	Oil	1.0/0.8	0.6/0.5	0.4/0.3	Yes	No
LD LCI Plan-Apochromat	25×	0.8	Oil, water or glycerin	2.9/6.5	1.7/3.8	0.9/2.0	Yes	Yes
C-Apochromat	10×	0.45	Water	4.2/20.2	2.4/11.7	1.3/6.1	Yes	Yes
C-Apochromat	40×	1.2	Water	2.1/1.9	1.3/1.1	0.7/0.6	Yes	Yes
C-Apochromat	63×	1.2	Water	1.4/1.3	0.8/0.7	0.5/0.4	Yes	Yes
LD C-Apochromat	40×	1.1	Water	2.1/2.3	1.3/1.4	0.7/0.7	Yes	Yes
Plan-Apochromat	63×	1.46	Oil	1.5/1.0	0.9/0.6	0.5/0.3	Yes	Yes
Plan-Fluar	100×	1.45	Oil	1.0/0.7	0.6/0.4	0.3/0.2	No	No
Plan-Apochromat	100×	1.46	Oil	1.0/0.7	0.6/0.4	0.3/0.2	Yes	No

# Technical Specifications

- › In Brief
- › The Advantages
- › The Applications
- › The System
- › **Technology and Details**
- › Service

## Dimensions (width × depth × height)

Apotome 3 slider for Axio Imager	Approx. 278 mm × 90 mm × 76 mm
Apotome 3 slider for Axio Observer	Approx. 295 mm × 90 mm × 78 mm
Apotome 3 slider for Axio Zoom.V16	Approx. 278 mm × 90 mm × 76 mm

## Weight

Apotome 3 slider	Approx. 1.1 kg
------------------	----------------

## Functional Data

Area of use	Closed rooms
Radio interference suppression	As per EN 55011 Class A
Noise immunity	As per DIN EN 61326-1

## Operating Data

Interference Suppression	In accordance with EN 55011 class A
Interference Resistance	In accordance with DIN EN 61326-1
Supply Voltage	24 V DC
Power Consumption Apotome 3	Max. 5 W

# Technical Specifications

- › In Brief
- › The Advantages
- › The Applications
- › The System
- › **Technology and Details**
- › Service

## Ambient Conditions for Operation

Permissible ambient temperature	+5 to +30 °C
Permissible relative humidity	Max. 80 % at +30 °C
Air pressure	800 hPa to 1060 hPa
Operating altitude	Max. 2000m
Pollution degree	2
Warm-up period	30 min

## Grid Frequencies (transmission grid high/medium/low)

Axio Imager slider	5/9/17.5 lp/mm
Axio Observer slider	10/17.5/35 lp/mm
Axio Zoom.V16 slider	10/15/20 lp/mm

## Installation Conditions

The grid projection method used for the Apotome 3 is sensitive to vibration, which can have various causes (including strong draughts). Vibrations are visible as streak artefacts in the resulting image. The microscope must therefore be set up so that it is exposed to as little vibration as possible on a vibration-damped table or on a suitable microscope base.



# Count on Service in the True Sense of the Word

- › In Brief
- › The Advantages
- › The Applications
- › The System
- › Technology and Details
- › **Service**

Because the ZEISS microscope system is one of your most important tools, we make sure it is always ready to perform. What's more, we'll see to it that you are employing all the options that get the best from your microscope. You can choose from a range of service products, each delivered by highly qualified ZEISS specialists who will support you long beyond the purchase of your system. Our aim is to enable you to experience those special moments that inspire your work.

## **Repair. Maintain. Optimize.**

Attain maximum uptime with your microscope. A ZEISS Protect Service Agreement lets you budget for operating costs, all the while reducing costly downtime and achieving the best results through the improved performance of your system. Choose from service agreements designed to give you a range of options and control levels. We'll work with you to select the service program that addresses your system needs and usage requirements, in line with your organization's standard practices.

Our service on-demand also brings you distinct advantages. ZEISS service staff will analyze issues at hand and resolve them – whether using remote maintenance software or working on site.

## **Enhance Your Microscope System.**

Your ZEISS microscope system is designed for a variety of updates: open interfaces allow you to maintain a high technological level at all times. As a result you'll work more efficiently now, while extending the productive lifetime of your microscope as new update possibilities come on stream.

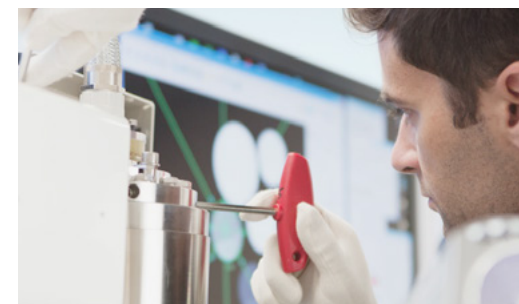

*Profit from the optimized performance of your microscope system with services from ZEISS – now and for years to come.*

>> [www.zeiss.com/microservice](http://www.zeiss.com/microservice)



**Carl Zeiss Microscopy GmbH**

07745 Jena, Germany  
microscopy@zeiss.com  
www.zeiss.com/apotome