

# Click. Count. Culture. AI power at your fingertips.

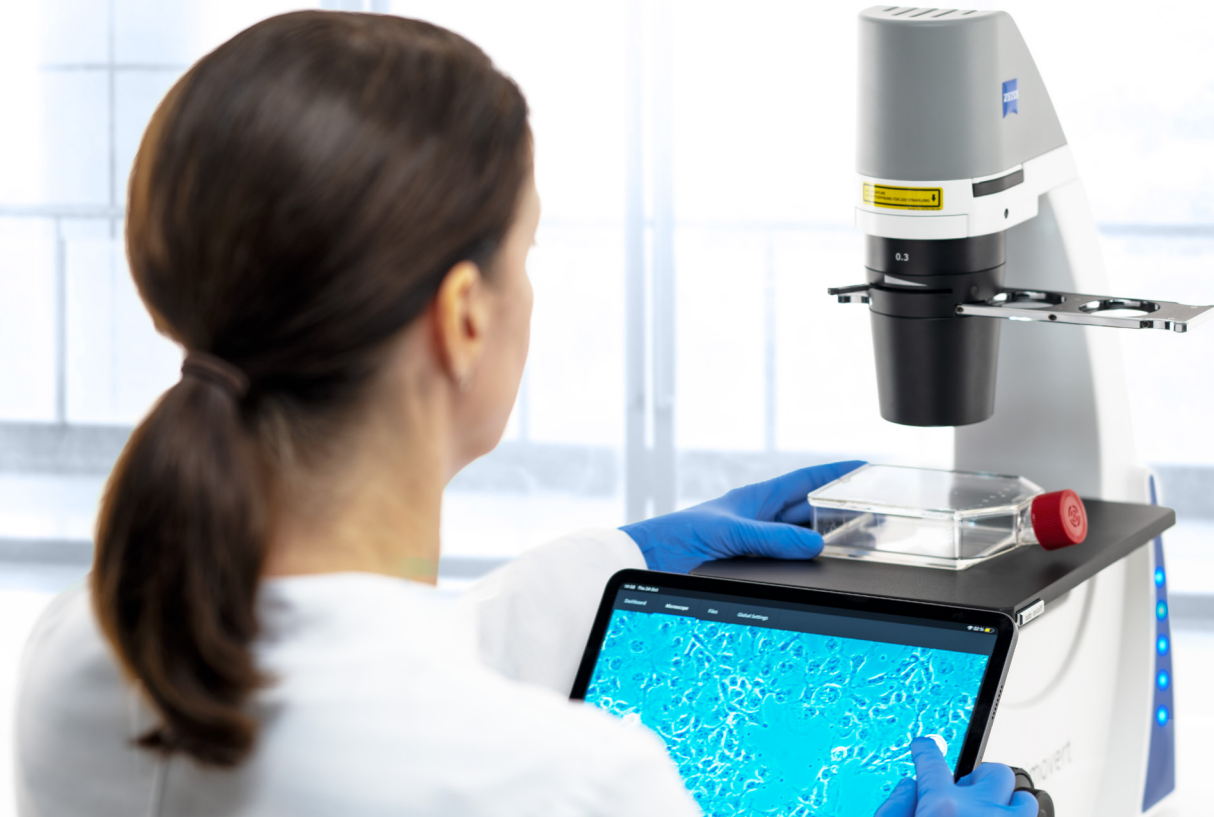

## **ZEISS Primovert and Primovert digital\***

Your compact inverted cell culture microscope.

[zeiss.com/primovert](https://zeiss.com/primovert)



Seeing beyond

# Click. Count. Culture.

## AI power at your fingertips.

- › In brief
- › The advantages
- › The applications
- › The system
- › Technical specifications
- › Service

Study the morphography of living cells and evaluate their development with these compact inverted microscopes from ZEISS. ZEISS Primovert and ZEISS Primovert digital are perfectly suited to your cell culture laboratory. They enable fast, efficient investigations of both unstained cells in phase contrast and GFP-labeled cells in fluorescence contrast. And they fit straight into your laminar flow cabinet to work directly in a sterile environment.

Now, with the power of integrated AI-based cell analysis, Primovert digital\* takes you one step further: transform images into insights instantly. The intelligent software ZEISS Labscope automatically recognizes, classifies, and quantifies your cells, giving you fast, reproducible results and freeing you from time-consuming manual evaluation. Gain confidence in your workflows, accelerate your decision-making, and share clear, standardized data with your team.

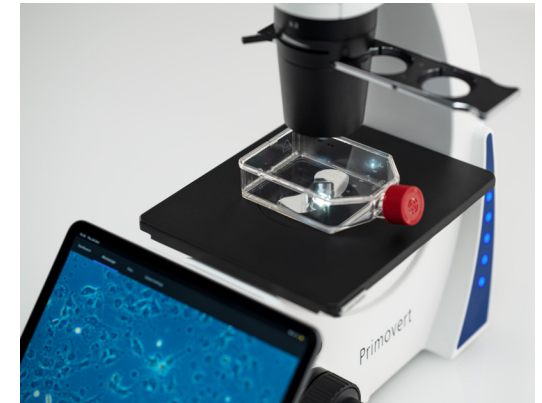

# Simpler. More intelligent. More integrated.

- › In brief
- › **The advantages**
- › The applications
- › The system
- › Technical specifications
- › Service

## **A compact microscope for your cell culture laboratory**

Everything about Primovert is designed to facilitate your daily work. Use the switch on the stand to shift effortlessly from phase contrast to fluorescence contrast, evaluating both unstained and GFP-labeled cells. Take your choice of mounting frames to work with various cell culture vessels such as petri dishes and well plates. And when you're using cell stacks or cell factories, simply remove the condenser. This compact inverse microscope fits neatly into your laminar flow cabinet so you can work directly in a sterile environment.

## **As rapid as your workflow: switch it on and start evaluating – all day, every day**

Your Primovert is always ready to go. Just use the convenient benchtop switch to turn the microscope on and off. Thanks to the integrated LED fluorescence, you start working right away – without warming up or cooling down. When idle, it shuts itself off automatically after 15 minutes – another energy-saving feature. Primovert is easy to use, easy on running costs – and easy on you, too.

## **Bring AI into your cell culture lab**

Primovert digital\* combines high-definition imaging with smart analysis: you can now count cells, adherent or in solution and measure confluency with a single click, without any manual effort. Perform instant measurements and analyses directly on your tablet using ZEISS Labscope with AI. This intelligent workflow solution saves valuable time, reduces errors, and significantly boosts productivity in your lab.



# Expand your possibilities



- › In brief
- › The advantages
- › **The applications**
- › The system
- › Technical specifications
- › Service

## Use ZEISS Primovert digital\* to bring AI into your cell culture lab

Unleash the functionality of ZEISS Labscope to convert your Primovert into a digital imaging system.

With Primovert digital you can:

- Count cells with one click — no manual effort needed.
- Measure and analyze instantly with built-in AI.
- Save time, reduce errors, and boost productivity.
- Start advanced cell culture work right out of the box.
- work in a laminar flow cabinet due to its compact design.



## Expand your possibilities

- › In brief
- › The advantages
- › **The applications**
- › The system
- › Technical specifications
- › Service



*LED illumination gives you the benefit of long life and stable color temperature. Use LED fluorescence to avoid warming up, cooling down and adjustment of the lamp. Work with constant brightness.*

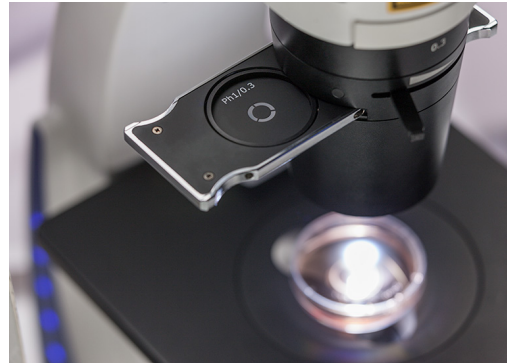

*Primovert has a universal phase slider for all objectives. You can use Ph1 for 10x, 20x and 40x magnification, and avoid having to adjust the phase position when you change the magnification.*



*When working with cell stacks or cell factories, you can increase the working distance by removing the condenser.*



*Charge your tablet directly at the Primovert digital stand. (Compatible with selected tablet models only)*



*You can use various mounting frames for flasks and multi-well plates as well as hemocytometer. For many petri dishes, you can also expand the stage.*



*Use the free ZEISS Labscope software to connect your microscope with multiple tablets and computers.*

# Tailored precisely to your applications

- › In brief
- › The advantages
- › **The applications**
- › The system
- › Technical specifications
- › Service

Task	ZEISS Primovert and Primovert digital offer
Evaluate unstained, transparent samples such as living cells.	Primovert is equipped with phase contrast. You can use a universal phase slider (Ph0, Ph1, and Ph2) for 4x, 10x, 20x, and 40x magnification for optimal contrast.
Excite and observe the fluorophore GFP.	With Primovert iLED, you can switch between brightfield and fluorescence contrast directly on the stand and evaluate both unstained and GFP-labeled cells.  The LED fluorescence provides even illumination of the sample. You avoid long warming up and cooling down phases as well as lamp adjustments.
Use the microscope to train technical assistants and students.	Primovert digital is designed for the joint observation of your results. You can connect one or several microscopes to each other. When using the Labscope imaging app for iPad, android and windows tablets, you can capture and share images.  Alternatively, you can use Primovert digital without an iPad with the help of laptop and projector.
Use the microscope over several hours.	In automatic mode, Primovert operates in standby. If the device is not used for 15 minutes, it automatically shuts itself off. Simply press a button to reactivate it.
Use the microscope in a sterile environment (laminar flow cabinet in cell culture laboratory).	Primovert's compact design enables the microscope to fit into any cell culture laboratory. You can put the microscope straight in your laminar flow cabinet, control it remotely, via Wi-Fi dongle and connect it to a laptop or tablet, thus working directly in a sterile environment.
Use various cell culture vessels such as petri dishes, multiwell plates, counting chambers and culture flasks.	Primovert comes with a variety of stage inserts for different cell culture vessels. When working with cell stacks, simply remove the condenser.
Perform cell counting, cell confluency measurement and evaluate transfection efficiency of your cells.	Use Primovert and Primovert digital* with Labscope and the AI modules for fast cell evaluation.

# ZEISS Primovert at work

- › In brief
- › The advantages
- › **The applications**
- › The system
- › Technical specifications
- › Service

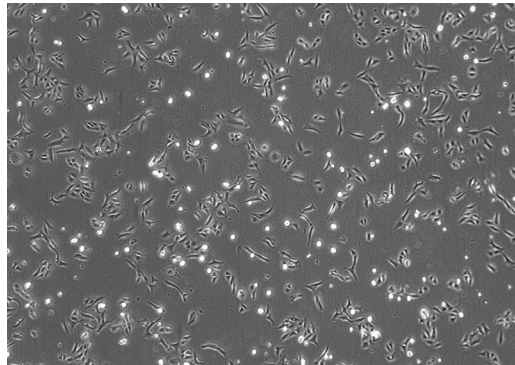

U2OS cells  
Magnification 40x, phase contrast

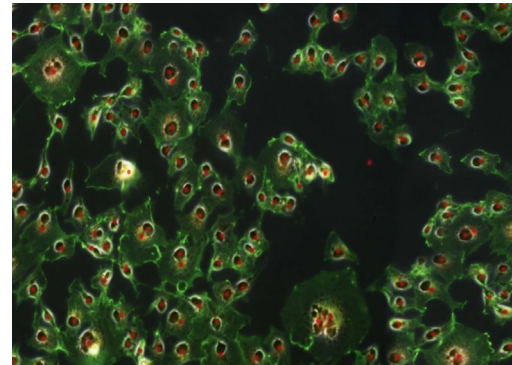

Nuclei count with Labscope AI cell counting module

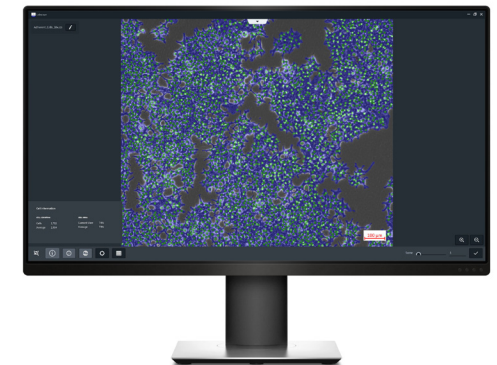

Labscope module for AI cell counting and AI cell confluency

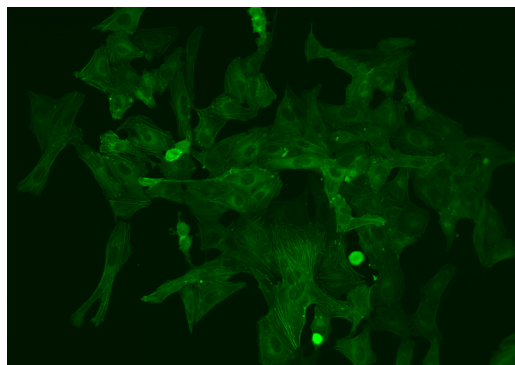

U2OS cells, GFP labeled  
Magnification 20x, fluorescence contrast



Labscope AI counting chamber

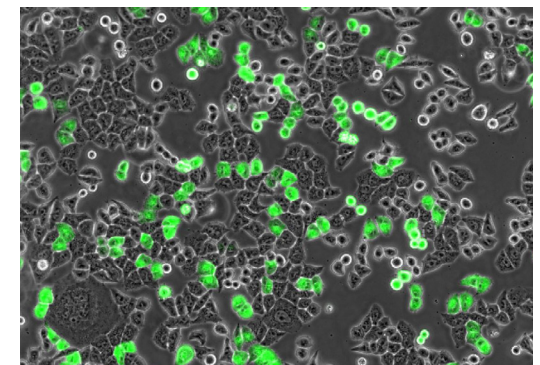

Transfection efficiency measurement

# Your flexible choice of components

- › In brief
- › The advantages
- › The applications
- › **The system**
- › Technical specifications
- › Service



## 1 Microscope

- Primovert
- Primovert iLED
- Primovert digital

## 2 Recommended objectives

- Plan-ACHROMAT 4×/0.10 HF
- Plan-ACHROMAT 4×/0.10 Ph0
- Plan-ACHROMAT 10×/0.25 Ph1
- LD Plan-ACHROMAT 20×/0.30 Ph1
- LD Plan-ACHROMAT 40×/0.50 Ph1
- LD Plan-ACHROMAT 20×/0.30 Ph2
- LD Plan-ACHROMAT 40×/0.50 Ph2

## 3 Condensers

- LD condenser 0.3 (working distance: 72 mm)
- LD condenser 0.4 (working distance: 55 mm)

## 4 Illumination

Transmitted light:

- HAL 30 W (halogen)
- LED

Reflected light:

- 470 nm fluorescence LED
- 38HE filter set

## 5 Cameras

Recommended cameras:

- Educam 105 color
- Axiocam 203 mono
- Axiocam 212 color

## 6 Software

- ZEN lite
- ZEISS Labscope

# Technical specifications

- › In brief
- › The advantages
- › The applications
- › The system
- › **Technical specifications**
- › Service

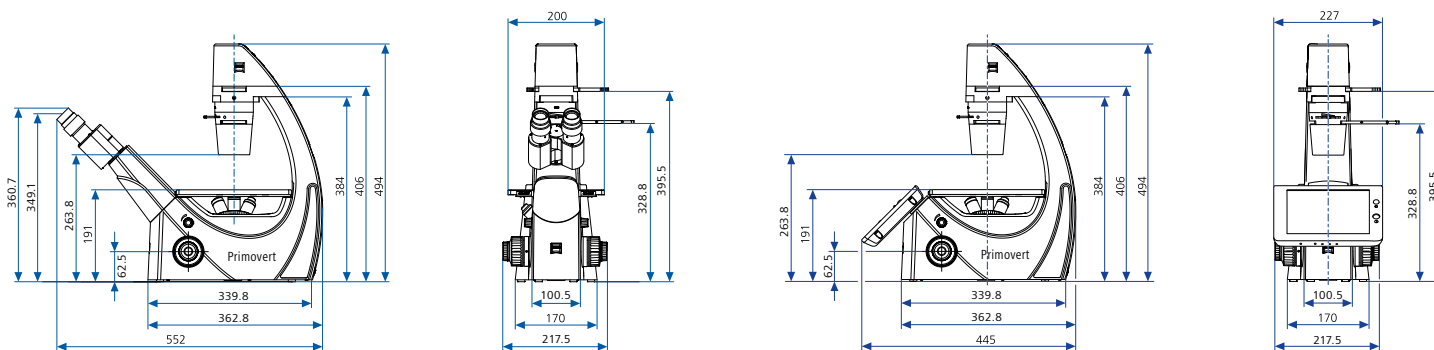

## Dimensions (width × depth × height)

Primovert	Approx. 261 mm × 550 mm × 494 mm
Primovert digital	Approx. 215.5 mm × 473 mm × 494 mm
Primovert iLED	Approx. 215.5 mm × 552 mm × 494 mm

## Weight (without accessories or packaging)

Primovert (without accessories or packaging)	Approx. 11 kg
Primovert digital	Approx. 11 kg
Primovert iLED	Approx. 11.5 kg

## Ambient conditions

### Transportation (in packaging)

Permissible ambient temperature	-40°C to +70°C
---------------------------------	----------------

### Storage

Permissible ambient temperature	+10°C to +40°C
Permissible humidity	Max. 75% at 35°C (without condensation)
On site storage without package	

### Operation

Area of use	Closed spaces
Max. altitude	2,000 m
Permissible ambient temperature	+10°C to +40°C
Permissible humidity	Max. 75 % at 35°C (without condensation)

# Technical specifications

- › In brief
- › The advantages
- › The applications
- › The system
- › **Technical specifications**
- › Service

## Technical specifications

Protection class	II
Protection type	IP20
Electrical safety	Primovert bino, trino, iLED: Pursuant to DIN EN 61010-1 (IEC 61010-1); Primovert digital: Pursuant to DIN EN 61010-1 (IEC 61010-1) and in accordance with CSA and UL standards.
Degree of pollution	2
Overvoltage category	II
Radio interference suppression	Pursuant to EN 61326-1
Main voltage	100 to 240 V (±10%); thanks to the worldwide power adapter, adjusting the voltage of the device is not required
Power frequency	50/60 Hz
Power consumption	Primovert bino, trino, iLED: 45W; Primovert digital: 60W; secondary voltage from external 12 V power supply unit
Output power supply unit	12 V DC; max. 5 A
Power consumption (Primovert iLED)	Max. 30 W; secondary voltage from external 12 V power supply unit
Output power supply (Primovert iLED)	12 V DC; max. 2.5 A
Microscope 12 V/6 V DC	Adjustable 1.5 V to 12 V
LED class of entire device	Risk group 1 pursuant to IEC 62471

## Light sources

<b>Halogen lamp</b>	HAL 6 V, 30 W
Light source adjustment range	Fully adjustable between 1.5 V and 6 V DC
Color temperature at 6 V	2,800 K
Luminous power	765 lm
Average life	100 hours
Illuminated area	1.5 × 1.5 mm

# Technical specifications

- › In brief
- › The advantages
- › The applications
- › The system
- › **Technical specifications**
- › Service

<b>LED illumination</b>	White-light LED, peak wavelength 450 nm, LED risk group 2 pursuant to IEC 62471
Fluorescent illumination	Blue LED, peak wavelength 470 nm, LED risk group 2 pursuant to IEC 62471
Homogeneous image field illumination	20 mm diameter
Analog brightness adjustment from	Approx. 15 to 100 %
Constant color temperature independent of brightness	7,000 K
Homogeneous image field illumination	20 mm diameter
Analog brightness adjustment from	Approx. 15 to 100 %
With field of view of 20	WF 10x/20 Br. foc.
<b>Optical and mechanical data</b>	
<b>Stand with stage focus</b>	
Using coarse adjustment	45 mm/rev
Using fine adjustment	0.5 mm/rev
Total lift	15 mm
Switching objectives	Manually using 4x nosepiece turret
Objectives	First-class infinity-focus objective range with screw thread W 0.8
Eyepieces with field of view of 20	30 mm plug-in diameter, WF 10x/20 Br. foc.
<b>Object stage</b>	
	Permanently installed
Dimensions (width × depth)	200 mm × 239 mm
<b>Stage adjustment</b>	
	Right
Verniers with number and letter scale	X-axis: number scale; read from right to left; y-axis: letter scale, read using the mirror
Coaxial drive	Right
<b>LD condenser 0.3</b>	for Vobj 4x to 40x, a = 72 mm
<b>LD condenser 0.4</b>	for Vobj 4x to 40x, a = 55 mm

# Technical specifications

- › In brief
- › The advantages
- › The applications
- › The system
- › **Technical specifications**
- › Service

## ZEISS Primovert

Maximum field of view	20
Eyepiece distance (pupil distance)	Adjustable from 48 to 75 mm
Viewing angle	45°
Viewing height	350 to 390 mm
Visual output	Tube factor 1x

## ZEISS Primovert digital\*

Camera	5-megapixel CMOS
Acquired field of view of the camera	5 MP (snap) and 2 MP (live and snap) 5 MP: 5.2mm × 3.9 mm, equivalent to 1/2.8" (6.5 mm diagonal) 2 MP: 5.1 mm × 2.9 mm (5.9 mm diagonal)
Integrated camera adapter	0.485x
Output	HDMI / USB3.0 / Ethernet port
Tablet mount	Tiltable from 40° to 80°

## Primovert iLED

Maximum field of view	20
Illumination	Epi-fluorescence / transmitted light
Fluorescence source	LED wavelength 470 nm
Transmitted light source	LED 7,000 K
Eyepiece distance (pupil distance)	Adjustable from 48 to 75 mm
Viewing angle	45°
Viewing height	350 to 390 mm
Visual output	Tube factor 1x

## ZEISS service – your partner at all times

Your microscope system from ZEISS is one of your most important tools. For over 175 years, the ZEISS brand and our experience have stood for reliable equipment with a long life in the field of microscopy. You can count on superior service and support – before and after installation. Our skilled ZEISS service team makes sure that your microscope is always ready for use.

- › In brief
- › The advantages
- › The applications
- › The system
- › Technical specifications
- › **Service**

### Procurement

- Lab planning & construction site management
- Site inspection & environmental analysis
- GMP qualification IQ/OQ
- Installation & handover
- IT integration support
- Startup training

### New investment

- Decommissioning
- Trade-in

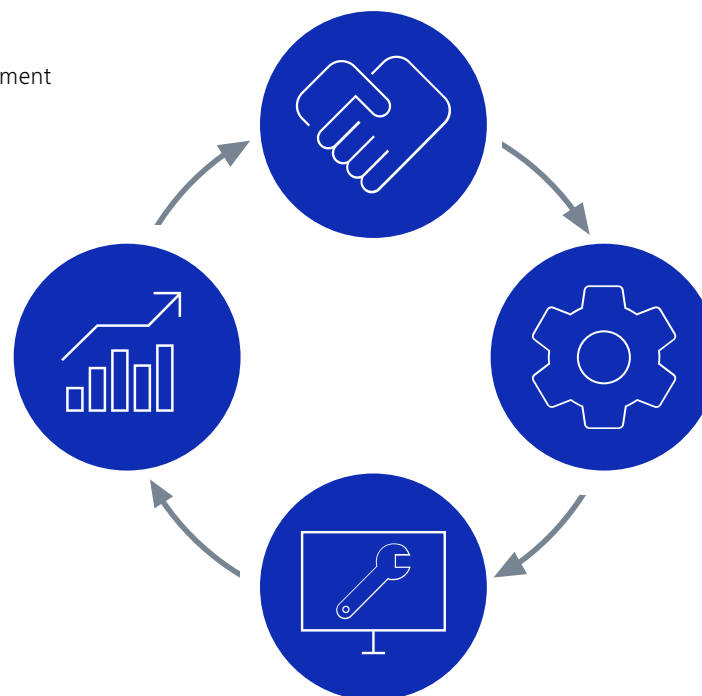

### Operation

- Predictive service remote monitoring
- Inspection & preventive maintenance
- ZEISS Software maintenance agreements
- Operation & application training
- Expert phone & remote support
- ZEISS Protect Service Agreements
- Metrological calibration
- Instrument relocation
- Consumables
- Repairs

### Retrofit

- Customized engineering
- Upgrades & modernization
- Customized workflows via ZEISS arivis Cloud software

Please note: Availability of services depends on product line and location

**Get in touch:**

[www.zeiss.com/microscopy/service](http://www.zeiss.com/microscopy/service)

\* The AI functions and Primovert digital are not intended to generate medical diagnostic results, either directly or indirectly.



**Carl Zeiss Microscopy GmbH**  
07745 Jena, Germany  
microscopy@zeiss.com  
[www.zeiss.com/primovert](http://www.zeiss.com/primovert)



Follow us on social media:

