

Imaging the near-to-native state



ZEISS Correlative Cryo Workflow

Your Solution for TEM Lamella Preparation and Volume Imaging under Cryogenic Conditions

zeiss.com/cryo



Seeing beyond

Your Solution for TEM Lamella Preparation and Volume Imaging under Cryogenic Conditions

- › In Brief
- › The Advantages
- › The Applications
- › The System
- › Technology and Details
- › Service

Cryogenic microscopy is an emerging technique for structural analysis of macromolecules in their cellular context. Because the ultrastructure of cells and tissues can be preserved free of artifacts and cellular processes are stopped instantaneously, cryogenic microscopy allows the examination of cellular structures in their near-to-native state. Vitrified samples can be imaged using light and electron microscopy, with each of these techniques revealing different information. However, cryogenic microscopy presents users with complex challenges, such as time-consuming preparation and imaging procedures, devitrification, ice contamination or loss of samples – and even more challenges if the user wants to correlate the obtained data across imaging modalities.

ZEISS Correlative Cryo Workflow overcomes these challenges by connecting widefield, laser scanning, and focused ion beam scanning electron microscopy in a seamless and easy-to-use procedure. The solution provides hardware and software optimized for the needs of correlative cryogenic workflows, from localization of fluorescent macromolecules to high-contrast volume imaging and on-grid lamella thinning for cryo electron tomography.

Unlike other solutions, the instruments that comprise this workflow can be used for both cryo and room temperature applications. This makes ZEISS Correlative Cryo Workflow solution a perfect choice for core imaging facilities, where instrument versatility is highly valued.

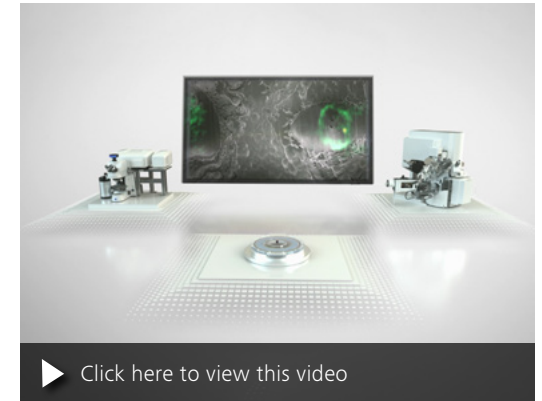

ZEISS Correlative Cryo Workflow



Simpler. More Intelligent. More Integrated.

- › In Brief
- › **The Advantages**
- › The Applications
- › The System
- › Technology and Details
- › Service

A simplified workflow to help you focus on your research.

To study the intact ultrastructure of biological samples, you need to maintain the vitrified state throughout your experiment. With ZEISS Correlative Cryo Workflow, you master the challenging combination of different imaging modalities under cryo conditions. The workflow solution connects light and electron microscopy, enabling volume imaging and efficient production of TEM lamellae. Dedicated accessories simplify the workflow and facilitate a safe transfer of cryo samples between the microscopes. Data management is assured by ZEN Connect, the ZEISS software for correlative microscopy, which keeps your data in context throughout the workflow. A series of processing tools help you enhance the imaging results.



Components of the ZEISS Cryo Accessory Kit

Superior optical components to give you best-in-class data quality.

Vitrified samples are challenging to image; therefore, it is important to combine only the most reliable modalities available. Thanks to cryo-compatible objectives and the high sensitivity of the Airyscan detector, ZEISS LSM systems enable you to detect proteins and cellular structures at high resolution while gentle illumination and constant low temperatures prevent your samples from devitrification. The ZEISS Crossbeam FIB-SEM lets you enjoy high-contrast volumetric imaging – even without heavy metal staining applied to your samples. Both modalities provide valuable functional and structural information that can give you a thorough understanding of ultrastructure, whether or not you follow up with TEM studies.

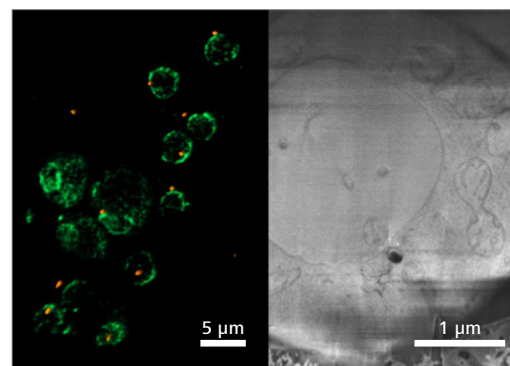

Double-labelled yeast cells (CNM67-tdTomato and NUP-GFP). LSM image (left) and Crossbeam image (right). Sample courtesy M. Pilhofer, ETH Zürich, Switzerland

Multipurpose solutions to maintain your imaging facility's productivity.

Unlike other solutions, the ZEISS microscopes involved in the workflow can be used not only for cryogenic microscopy, but also for room temperature applications, which is particularly advantageous when the microscopes are not being fully utilized for cryogenic experiments. Here, the ZEISS microscopes show their high-quality imaging strengths for a wide range of other applications. Converting the instruments from cryogenic to room temperature usage is done quickly and doesn't require technical expertise. This flexibility gives users more time for their experiments. Imaging facilities benefit from better utilization and a faster return on investment. The funds saved can be invested in other technologies.

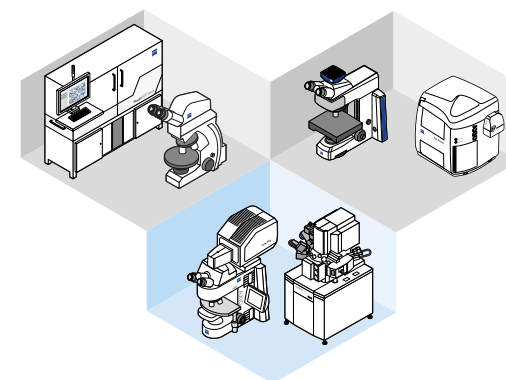

Your Insight into the Technology Behind It

- › In Brief
- › **The Advantages**
- › The Applications
- › The System
- › Technology and Details
- › Service

ZEISS Correlative Cryo Workflow at a glance

1. Sample loading (Correlative Cryo Holder)

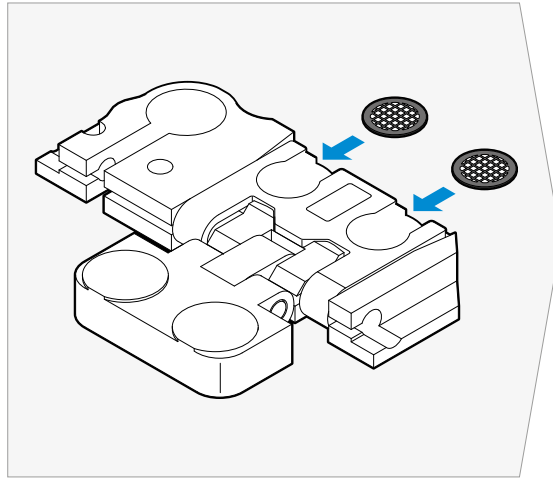

2. Cryo LM (Axio Imager, LSM with Airyscan)

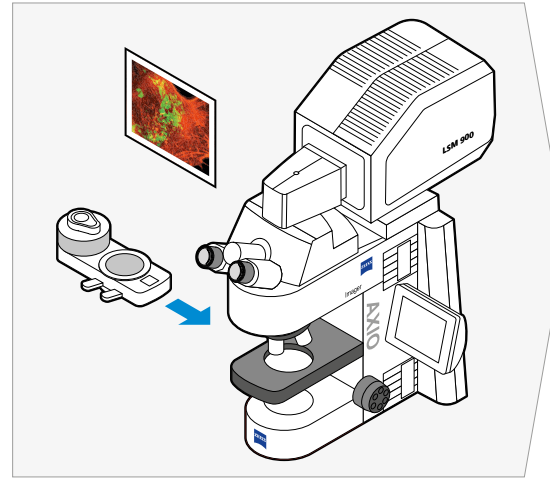

3. Sample transfer to FIB-SEM

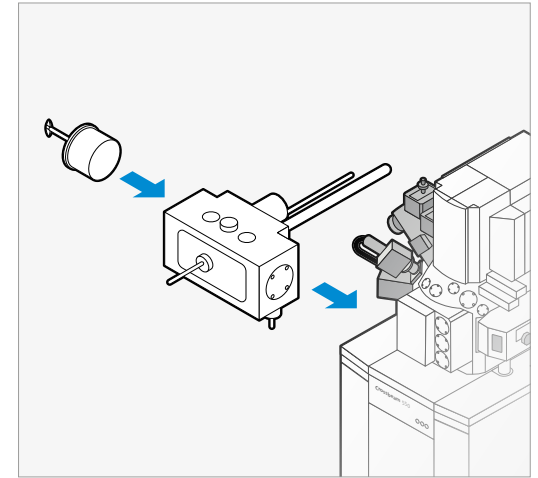

4. Cryo FIB-SEM (Crossbeam)

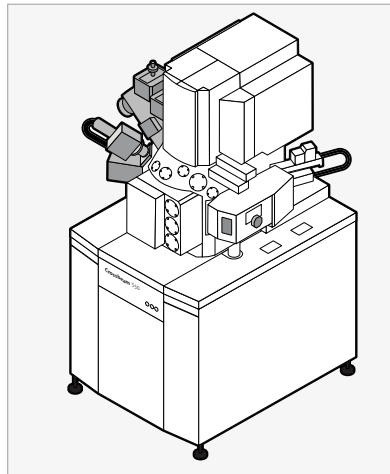

4a. 3D volume imaging

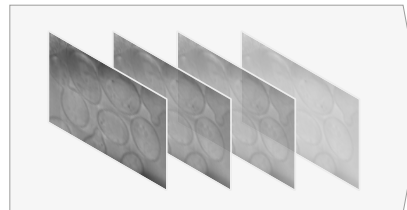

5a. Image processing

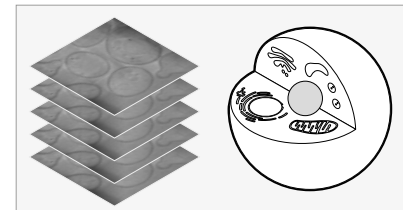

4b. TEM lamella preparation

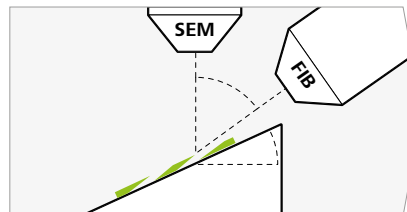

5b. Cryo TEM

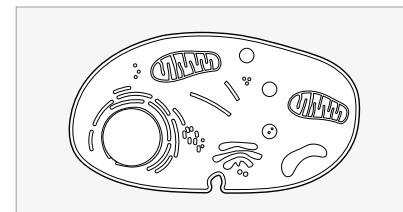

6. Visualization

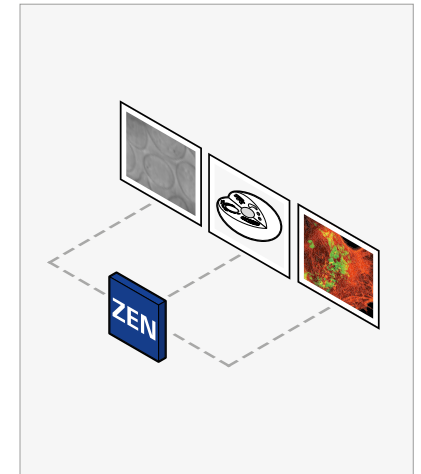

Your Insight into the Technology Behind It

- › In Brief
- › **The Advantages**
- › The Applications
- › The System
- › Technology and Details
- › Service

ZEISS Cryo Accessory Kit

ZEISS Correlative Cryo Workflow allows the use of various sample carriers. Whether you use TEM grids, AutoGrid, sapphire discs or HPF planchets, you can count on the Cryo Accessory Kit to enable easy loading, transfer and storage of your sample. A collection of items and tools supports safe sample handling throughout the entire workflow.

Your vitrified sample is mounted safely and protected within the specifically designed Correlative Cryo Holder. The holder allows you to store and transfer your sample between microscopes while keeping it protected from ice contamination and physical damage.

The components of the Cryo Accessory Kit are compatible with the cryo-correlative microscopy stage Linkam CMS196V³ and the cryo system Quorum PP3010Z.



TEM prep slusher of the Quorum Prepdek[®] workstation with ZEISS Perspex lid; components of the ZEISS Cryo Accessory Kit



ZEISS Cryo Accessory Kit

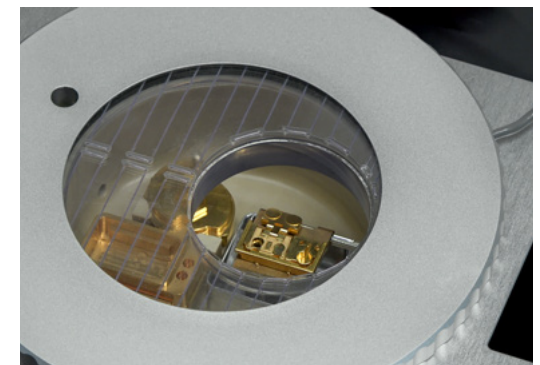

ZEISS Correlative Cryo Holder in the Linkam CMS196V³ cryo-correlative microscopy stage

Your Insight into the Technology Behind It

- › In Brief
- › **The Advantages**
- › The Applications
- › The System
- › Technology and Details
- › Service

Cryogenic widefield and confocal microscopy: ZEISS Axio Imager, ZEISS LSM 900/980 with Airyscan 2

ZEISS Axio Imager, the light microscope of choice for the ZEISS Correlative Cryo Workflow, can be equipped with the cryo microscopy stage CMS196V³ from Linkam. Depending on your requirements, you can configure the Axio Imager as:

- a widefield system (with Apotome 3 to acquire 3D datasets)
- an LSM 900/980 with Airyscan 2 for high-resolution confocal imaging

The hardware is designed to prevent devitrification and ice contamination during imaging. Objectives are available with a range from 5x to 100x to support imaging from low magnification overview to high-resolution. Different illumination methods, like reflected or transmitted light mode, enable investigation of your sample from different perspectives to provide extra information about ice thickness and sample quality. Thanks to the sensitive Airyscan detector, which allows very gentle illumination, high resolution cryogenic imaging becomes possible.

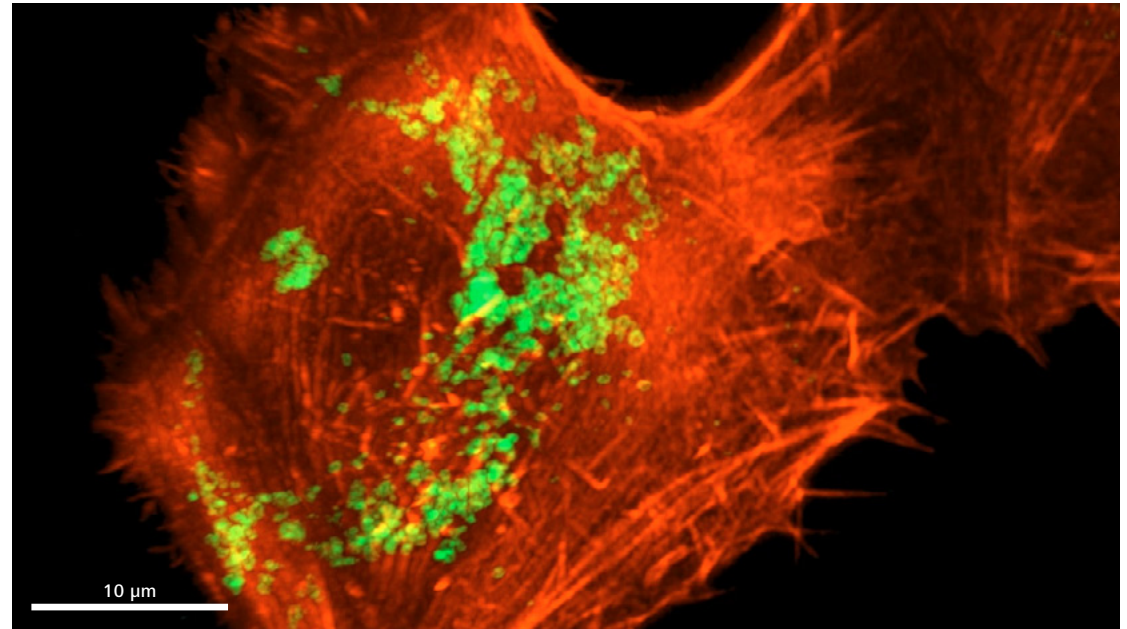

Adenocarcinoma cells (Actin-mCherry: red, Mitochondria stained with Mitotracker: green). Imaged with LSM Airyscan.

Both the LSM and the widefield microscope are multipurpose tools that can be converted quickly from cryo to room temperature experiments and vice versa without compromising image quality.



ZEISS LSM 900

Your Insight into the Technology Behind It

- › In Brief
- › **The Advantages**
- › The Applications
- › The System
- › Technology and Details
- › Service

Cryogenic scanning electron microscopy and TEM lamella preparation:

ZEISS Crossbeam

FIB-SEM technology is well-established in various disciplines, but also found its way into life sciences both as a tool for cutting biological samples with the highest precision and because its imaging capabilities are ideal for unveiling the ultrastructure.

ZEISS Crossbeam was designed to give you highest usability and best image contrast. Even with unstained vitrified samples, this FIB-SEM generates high-contrast images at cryogenic temperatures, allowing the investigation of the ultrastructure of cells and tissues, and making cellular compartments clearly visible.

Typically, the low acceleration voltages required for cryogenic SEM imaging come with the trade-off of low contrast. ZEISS Crossbeam generates high contrast even at low acceleration voltages, a result of the unique interaction between the Gemini electron optics and the detectors. This configuration also opens the possibility to observe the imaging and milling procedure in real time – you can precisely control the milling process and ensure targeted on-grid thinning of ultrathin TEM lamellae.

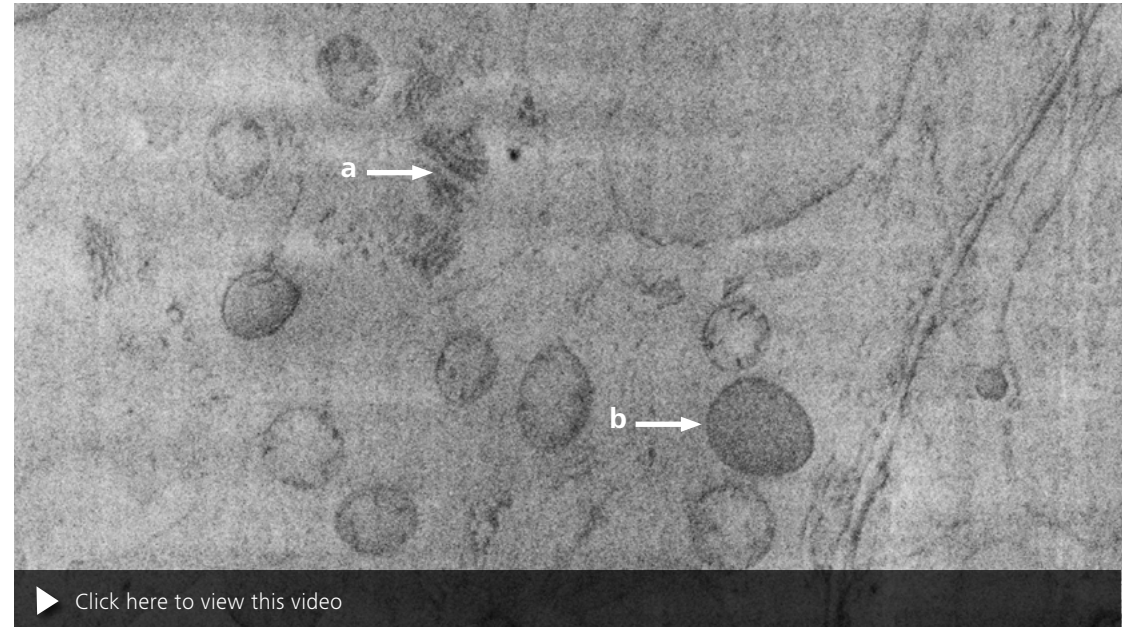

Arabidopsis root (high-pressure frozen). Ultrastructural details such as Golgi stacks (a) and plastids (b) are clearly visible.

As for the light microscopes, ZEISS Crossbeam can be used as a multipurpose tool without any compromise in performance.



ZEISS Crossbeam

Your Insight into the Technology Behind It

- › In Brief
- › **The Advantages**
- › The Applications
- › The System
- › Technology and Details
- › Service

Easy sample transfer and safe sample handling inside ZEISS Crossbeam: Quorum PP3010Z

ZEISS Correlative Cryo Workflow comes with Quorum PP3010Z, a highly automated, easy to use, gas-cooled cryo preparation system.

- The **cryo preparation chamber** is turbo-molecular pumped and includes tools for controlled, automatic sublimation and sputter coating. No additional equipment is needed – this saves time, simplifies the workflow and reduces the risk for ice contamination.
- From the cryo preparation chamber connected directly to the ZEISS Crossbeam chamber, the vitrified sample is transferred onto a **highly stable cold stage** for imaging and milling. The highest stability is ensured by the **ZEISS Cryo Drift Reduction module**, supporting stable volume imaging over a long time period and robust on-grid lamella preparation.
- **Cold trapping** in the cryo preparation chamber and Crossbeam chamber protects the sample from ice contamination.
- **Continuous cooling for at least 24 hours** is ensured by the CHE3010 off-column cooling system.
- All Quorum cryo components are controlled by the **Prepdek® workstation**, which also contains the vacuum storage tube for the cryo transfer device and the TEM prep slusher for the ZEISS loading station.



Quorum Prepdek® workstation

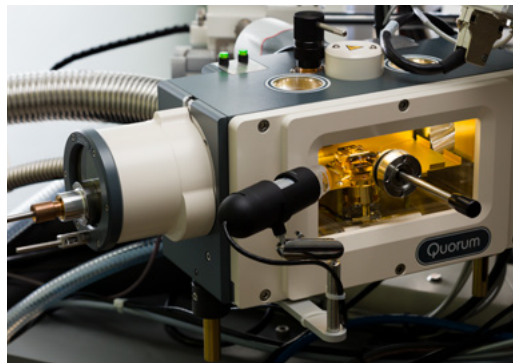

Cryo preparation chamber mounted on ZEISS Crossbeam



Rotatable cryo substage

Your Insight into the Technology Behind It

- › In Brief
- › **The Advantages**
- › The Applications
- › The System
- › Technology and Details
- › Service

Keeping everything together: A well-aligned software package

To ensure a streamlined correlative cryo workflow and that the various components work together seamlessly, the software platforms involved were extended to include cryo-specific functions. Additional software modules have been developed to address the challenges arising from correlative cryogenic microscopy.

ZEISS ZEN

ZEN imaging software controls the light microscopes and the Linkam CMS196V³ cryo stage.

ZEISS ZEN Connect

During the entire workflow, all light microscope and FIB-SEM data are organized with ZEN Connect, the centerpiece for correlation and navigation.

SmartSEM and SmartFIB

The standard Crossbeam operating software enables volume imaging and on-grid lamella thinning under cryogenic conditions.

Cryo Drift Reduction

This ZEISS patented solution reduces drift to ensure highest imaging and milling precision over longer time periods.

ZEN EM Processing Toolbox

This new ZEN module provides a bundle of image processing tools, such as 3D dataset registration and reduction of noise and milling artefacts.

3Dxl/3Dxl+

3Dxl is used for visualization of correlative LSM and FIB volumes. New features improve the visualization of light microscopy images with dense and feature-rich EM volume data. Cross sections can be visualized as 3D animations.

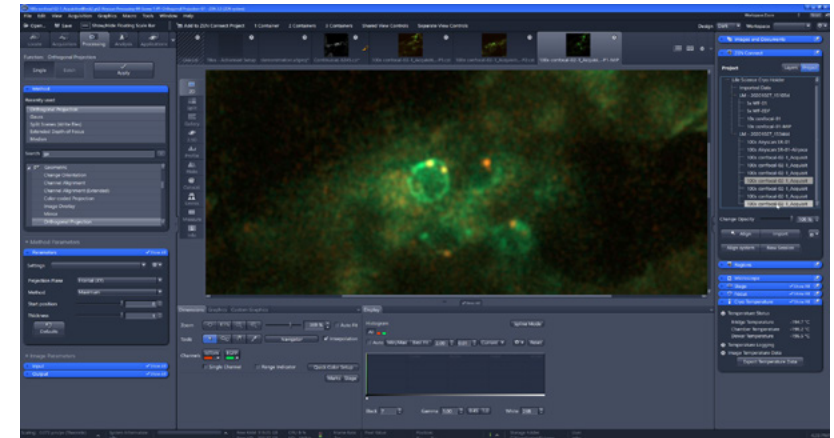

ZEISS ZEN

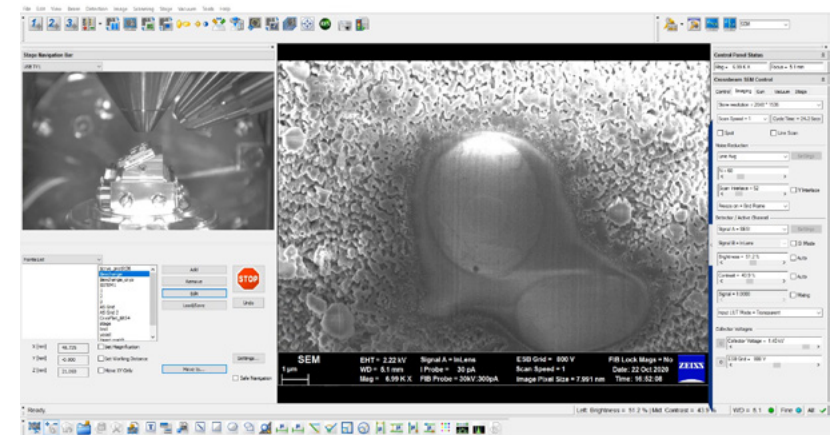

ZEISS SmartSEM / SmartFIB

Your Insight into the Technology Behind It

- › In Brief
- › **The Advantages**
- › The Applications
- › The System
- › Technology and Details
- › Service

Navigation, correlation and data management: ZEN Connect

ZEN Connect is a software module in ZEN that brings all your imaging technologies together and lets you combine multiple perspectives of your sample across scales and imaging modalities. Your multimodal data is saved in well-organized projects with intuitive image labels. ZEN Connect always shows your data in context – which makes it a perfect fit for correlative cryo microscopy.

Regions of interest previously identified with the light microscope can be relocated easily in the FIB-SEM once the alignment is done. ZEN Connect always keeps your data connected, both during imaging and later when sharing the whole story of your experiment.

Features to support ZEISS Correlative Cryo Workflow:

- **Stage mode:** Rotate the view on your data according to the current microscope coordinate system.
- **Correlative Cryo Holder:** ZEN Connect provides an outline of the holder for easy alignment.

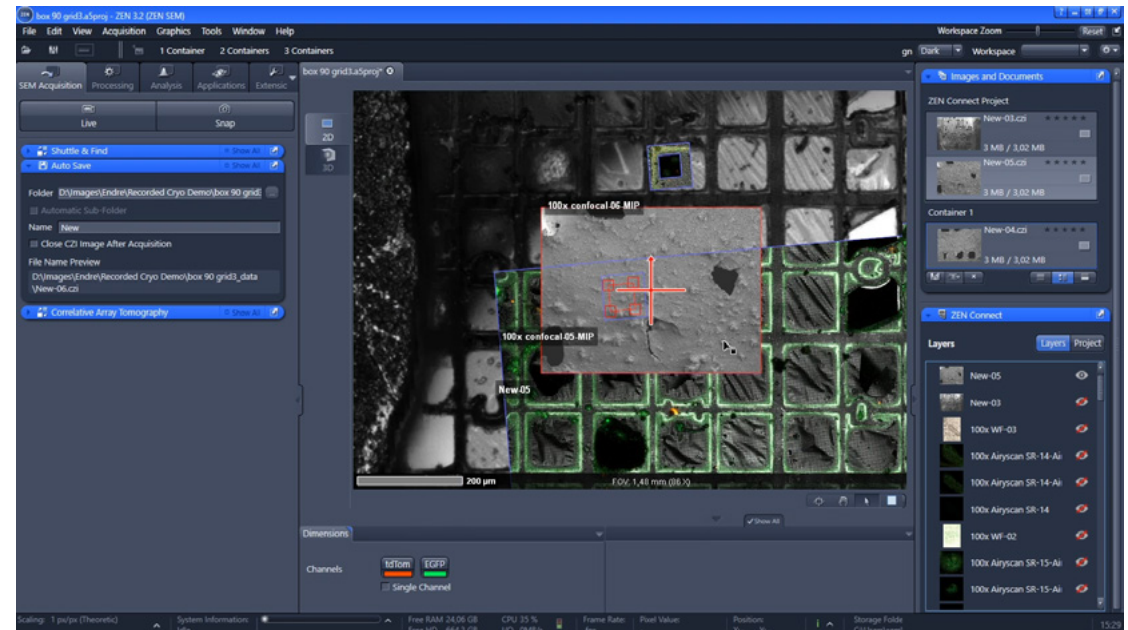

Correlative cryo dataset in ZEISS ZEN Connect

- **Z-alignment:** Images from different systems can be aligned with each other in the z dimension.
- **FIB stack import:** TIFF stacks from SmartFIB can be imported and used in ZEN Connect.
- **3D rotation:** For non-orthogonal stacks, the stack rotation can be freely adjusted.
- **Correlative 3D viewer:** Volumes from the light microscope and the FIB-SEM can be displayed in a combined 3D view.
- **SerialEM export:** ZEN Connect overview images can be exported into the SerialEM format for navigation on a TEM.

Your Insight into the Technology Behind It

- › In Brief
- › **The Advantages**
- › The Applications
- › The System
- › Technology and Details
- › Service

Optimize your EM images according to your needs: ZEN EM Processing Toolbox

The EM Processing Toolbox provides a selection of tools that can improve the quality of EM images. 2D image stacks acquired with SmartSEM can be imported into ZEN and converted into a 3D dataset. The toolbox also provides functions to further process EM data to enhance visualization of cellular structures and compartments for better identification.

Select from a variety of filters and processing tools:

- **Import EM images** acquired with SmartSEM or any other acquisition software in TIFF format.
- **Reduce artifacts** such as noise and stripes caused by the milling procedure.
- **Register the subsequent 2D images and create 3D datasets.** Let the z alignment tool automatically align your datasets.
- **Replace individual slices** of poor quality within the z-stack.
- **Select and crop free-form 3D regions** in order to remove unwanted regions from the EM image stack for a more customized 3D visualization.

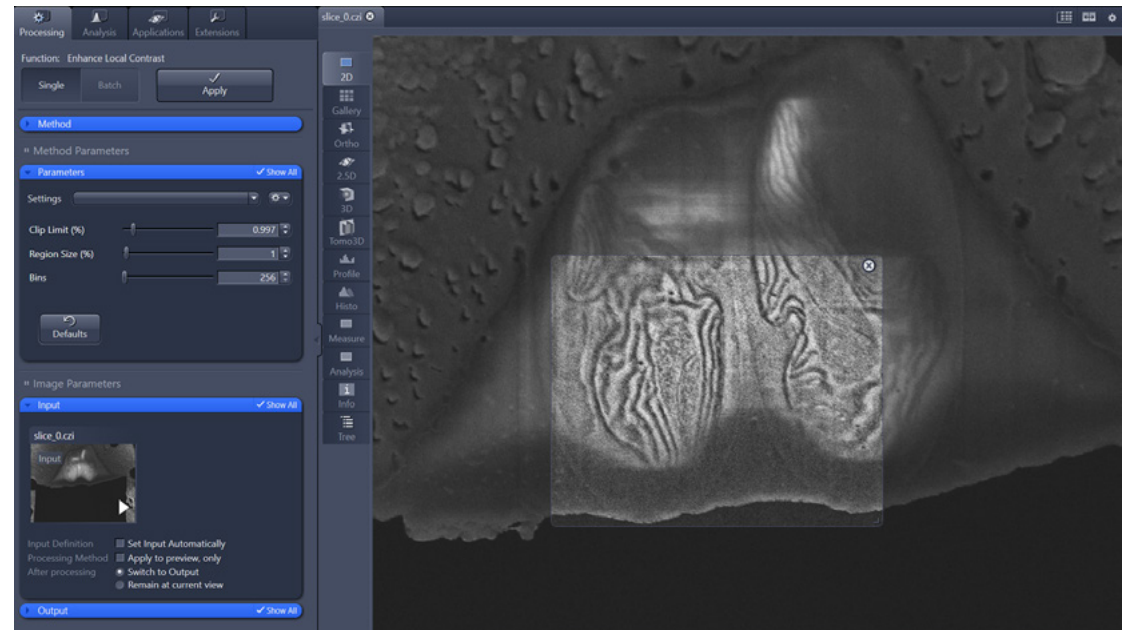

ZEN EM Processing Toolbox: Local contrast enhancement

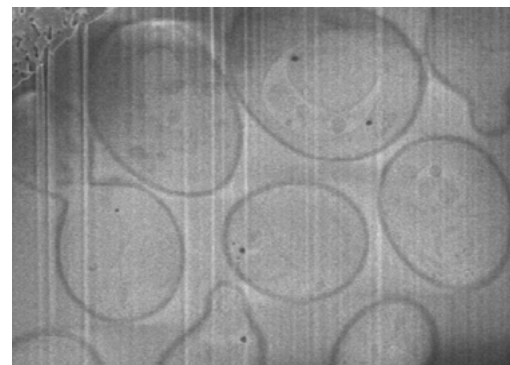

Raw image

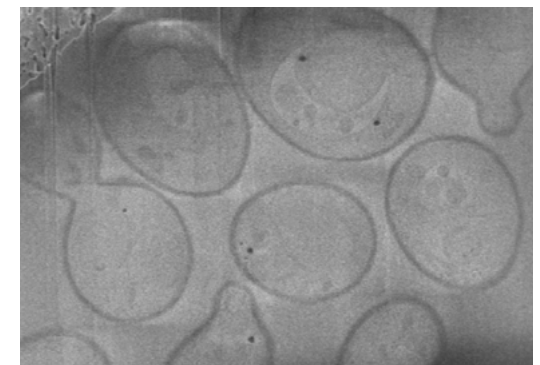

Processed image: stripes removed

Your Insight into the Technology Behind It

- › In Brief
- › **The Advantages**
- › The Applications
- › The System
- › Technology and Details
- › Service

ZEISS Correlative Cryo Workflow: The solution to typical challenges of cryogenic microscopy

Workflow-related challenges	ZEISS solution
Loss of samples due to size and fragility of sample carriers	<ul style="list-style-type: none"> ■ Various sample carrier types can be loaded easily into the Correlative Cryo Holders using a specially-designed loading station. ■ The Correlative Cryo Holders guarantee safe transfer of sample carriers between the microscopes. ■ Storage containers allow safe storage of the Correlative Cryo Holder.
Ice contamination	<ul style="list-style-type: none"> ■ The Correlative Cryo Holder is equipped with a lid to reduce contact with the atmosphere. ■ The technical design of the cryo LM stage and Quorum cryo stage ensures stable environmental conditions. ■ A reduced number of transfer steps minimizes the likelihood of ice contamination (e.g., sublimation and sputter coating in the Quorum cryo preparation chamber without requiring an additional device). ■ The Anticontaminator temperature in Crossbeam is always kept 30 °C lower than the cold stage.
Devitrification due to an accidental warming of the vitrified sample during the correlative cryo workflow	<ul style="list-style-type: none"> ■ The sample carrier is safely mounted inside a holder and covered with a lid. ■ Transfer and storage devices minimize the risk for accidental warming of the sample. ■ The Crossbeam cold stage provides low temperatures of < -150 °C.
Compatibility with cryo TEM	<ul style="list-style-type: none"> ■ Prepared TEM lamellae can be transferred to any manufacturer's cryo TEM.
Core facility business-related challenges	ZEISS solution
Warm-up and cool-down times	<ul style="list-style-type: none"> ■ Whether for cryogenic or room temperature experiments, instruments are ready for operation quickly. ■ Linkam CMS196V³ cool-down time: 5 min ■ Warm-up time of the LM system: simply replace the Linkam stage with a non-cryo stage. ■ Quorum PP3010Z cool-down and warm-up time: 90 min to equilibrated state
Availability of microscopes	<ul style="list-style-type: none"> ■ The ZEISS microscopes involved in the workflow can be used for cryogenic microscopy as well as for room temperature applications. ■ Both the ZEISS LSM and FIB SEM systems offer superior image quality for a wide range of demanding applications.
Light microscopy related challenges	ZEISS solution
Devitrification due to excitation power	<ul style="list-style-type: none"> ■ The high sensitivity of the Airyscan detector allows gentle illumination to avoid devitrification. ■ Gentle LED illumination is available in widefield.
Sample navigation: Acquisition of both overview images and high-resolution images	<ul style="list-style-type: none"> ■ Image acquisition with objectives from 5x to 100x magnification give the user high flexibility for both sample navigation and image acquisition. ■ ZEN Connect collects and displays the images for seamless navigation.
Acquisition of high-resolution images at < -140 °C	<ul style="list-style-type: none"> ■ The combination of a 100x NA 0.9 objective with the Airyscan detector enables significantly improved identification and localization of structures of interest and therefore, an increased ability to compare data from LSM and FIB-SEM.
Relocation of sample regions	<ul style="list-style-type: none"> ■ After alignment is performed once, ZEN Connect transfers coordinates to all associated images.
Devitrification due to inadequate temperature management of the microscope. Required low temperatures are not achievable.	<ul style="list-style-type: none"> ■ The Linkam cryo stage provides liquid nitrogen cooling to keep the temperature at -196 °C.

Your Insight into the Technology Behind It

- › In Brief
- › **The Advantages**
- › The Applications
- › The System
- › Technology and Details
- › Service

ZEISS Correlative Cryo Workflow: The solution to typical challenges of cryogenic microscopy

FIB-SEM related challenges	ZEISS solution
Relocation of sample regions	<ul style="list-style-type: none"> ■ Once alignment is performed, ZEN Connect transfers coordinates to all associated images.
Devitrification due to inadequate temperature management of the microscope. Required low temperatures are not achievable.	<ul style="list-style-type: none"> ■ Quorum PP3010Z provides controlled, targeted cooling to $-150\text{ }^{\circ}\text{C}$ or lower, with rapid thermal response by means of a cold stage and a cold trap.
Low-contrast EM images do not allow relocation of regions of interest	<ul style="list-style-type: none"> ■ ZEN Connect enables easy relocation of regions of interest. ■ ZEISS Crossbeam allows simultaneous imaging and milling. This configuration opens the possibility for monitoring the imaging and milling procedure in real time.
Low-contrast EM images do not reveal any structural information	<ul style="list-style-type: none"> ■ The high contrast of ZEISS Crossbeam reveals ultrastructure, a result of the unique interaction between the Gemini electron optics and the detectors.
Orientation of sample for lamella preparation	<ul style="list-style-type: none"> ■ Quorum PP3010Z comes with an endless rotatable cryo substage.
Charging of vitrified samples during imaging	<p>Charging can be minimized by:</p> <ul style="list-style-type: none"> ■ Automatic sublimation of ice crystals within the cryo preparation chamber directly attached to the FIB-SEM ■ Automatic sputtering within the cryo preparation chamber to render the sample conductive; no external sublimation and sputter coating device needed ■ High detector sensitivity permits gentle imaging to mitigate charging effects
Stage drift due to temperature variations	<ul style="list-style-type: none"> ■ The Cryo Drift Reduction module assures stable image acquisition as well as reliable lamella preparation at marked positions.
Software-related challenges	ZEISS solution
Organization of images from different imaging modalities	<ul style="list-style-type: none"> ■ Images are organized and managed within ZEN Connect projects for efficient search and recall.
Images with acquisition artifacts	<ul style="list-style-type: none"> ■ Various filter algorithms allow processing images whose quality is affected by artifacts.
Image registration	<ul style="list-style-type: none"> ■ 2D TIFF images acquired with the FIB-SEM can be registered and converted into a 3D image stack.
Correlation of LM and EM datasets	<ul style="list-style-type: none"> ■ LM and EM data can be correlated with ease thanks to ZEN Connect.
Complicated user experience due to a multitude of software platforms from different vendors	<ul style="list-style-type: none"> ■ All ZEN software packages and modules provide a similar user experience and are well aligned to avoid compatibility issues.
Visualization of datasets from different imaging modalities	<ul style="list-style-type: none"> ■ The 3Dxl viewer is integrated in ZEN; no additional software platform is needed.

Your Insight into the Technology Behind It

- › In Brief
- › **The Advantages**
- › The Applications
- › The System
- › Technology and Details
- › Service

Evaluation of sample quality and prevention of sample damage

Loss of samples, ice contamination and de-vitrification are well-known problems in cryo microscopy. ZEISS Correlative Cryo Workflow is designed to protect your precious vitrified samples against many conceivable pitfalls which can occur during this ambitious workflow. ZEISS Cryo Accessory Kit together with the imaging capabilities of ZEISS LSM/AiryScan and ZEISS Crossbeam mitigate the risk of losing or destroying your sample while working under cryo conditions.

Prior to managing your sample in the workflow, vitrification is a challenge in itself. Despite recent development of vitrification technologies, samples are often still covered under a thick ice layer or only partially vitrified and show areas of non-amorphous ice. Poor vitrification destroys the ultrastructure of cells and tissues. These areas can be identified only in a TEM unless your light microscope or the FIB-SEM provide methods for sample evaluation early in the workflow. ZEISS LSMs provide such evaluation capability by enabling different contrast methods. The outstanding contrast performance of ZEISS Crossbeam also allows reliable assessment of the sample quality. This will save you time and improve experiment efficiency.

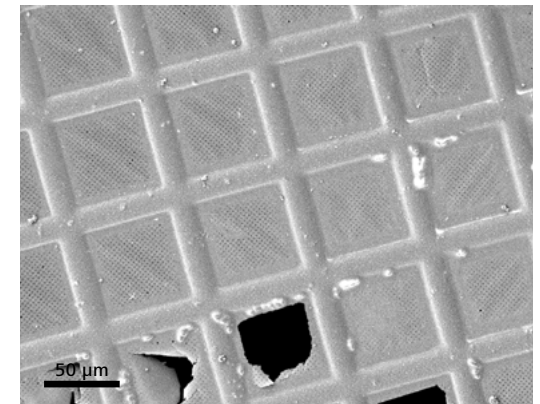
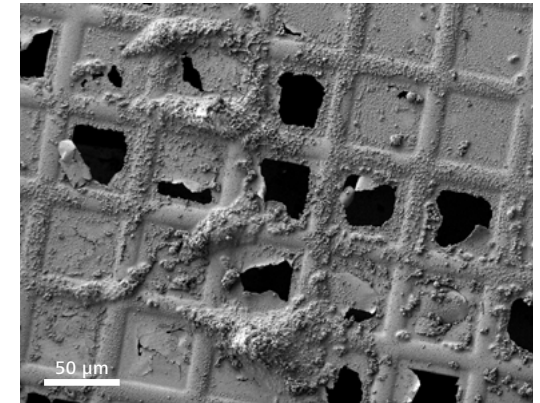
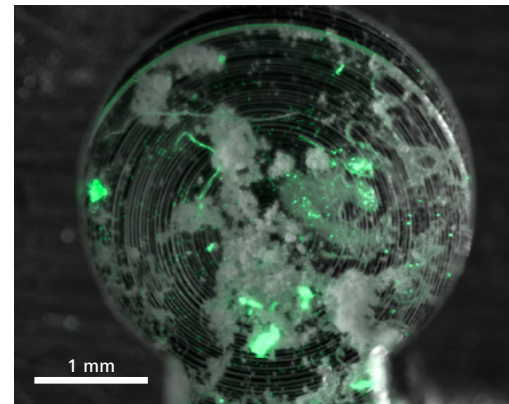
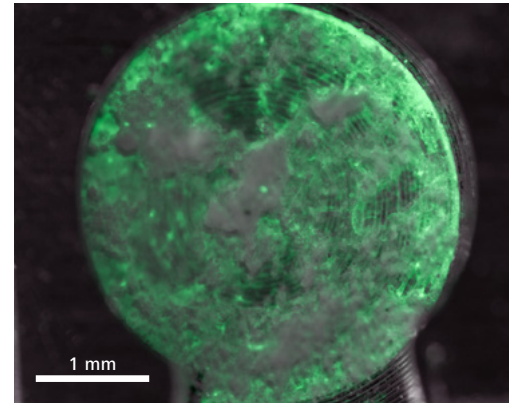

HPF carriers with vitrified samples. The samples were inspected for ice damage by using different contrast methods (fluorescence, reflected light) at the light microscope. The first sample shows ice-contamination and de-vitrification and was deselected from further EM imaging. The example below shows areas with ice contamination but also areas with well-vitrified regions (translucent areas). Image Courtesy: A. Akiva & N. Sommerdijk, Radboud University Medical Center, The Netherlands

TEM grids with vitrified samples. The upper image shows ice crystals on top of a grid. No ice contamination is visible on the TEM grid below.

The images show vitrified samples on HPF planchets (left) and TEM grids (right) with and without ice contamination.

Your Insight into the Technology Behind It

- › In Brief
- › **The Advantages**
- › The Applications
- › The System
- › Technology and Details
- › Service

Ice thickness measurement and efficient ROI targeting

Ice thickness measurement is crucial for judging the quality of samples and to locate the cells of interest within the vitrified specimen. By means of the light microscope, your sample can be validated easily. Reflected light and confocal fluorescence imaging give the first hints about the quality and let you clearly localize promising cells.

Spiderweb-fuzzy patterns of the fluorescent signal often indicate bad freezing. Furthermore, plunge-frozen samples will show different freezing quality and preservation within one sample. The information about ice thickness and ice quality enables the time-saving pre-selection of cells before moving on to the next step within the correlative cryo workflow.

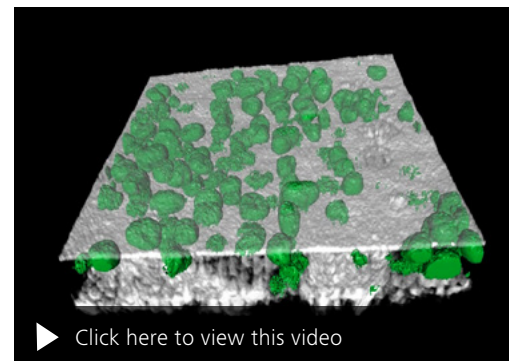
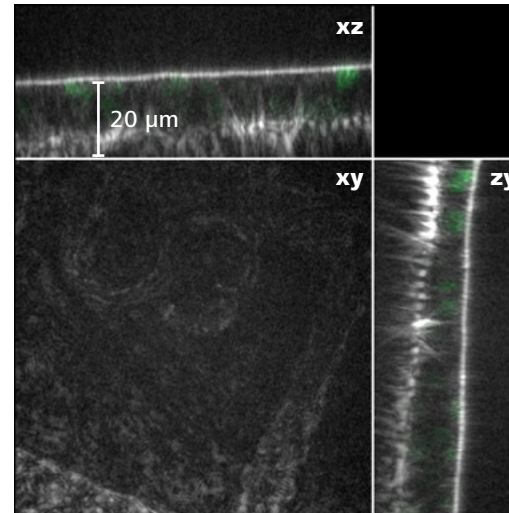

Images show plunge-frozen HeLa cells (Histone 2-GFP labeled) in a very thick ice layer. Such thick regions should be excluded from further FIB-SEM processing because of the high risk of freeze damage. Ice thickness was determined to be 20 µm.

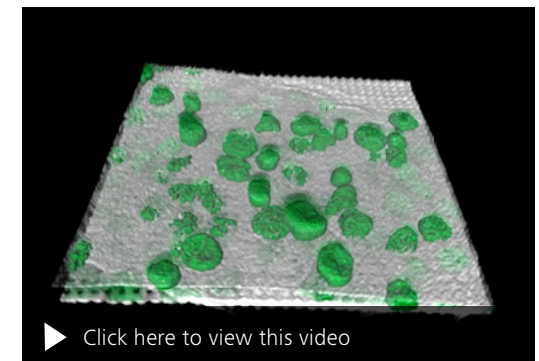
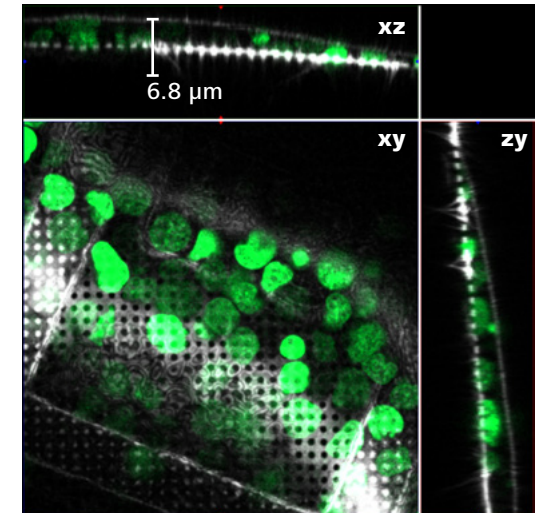

Images show plunge-frozen HeLa cells (Histone 2-GFP labeled) illustrating ideal conditions for further imaging. The ice layer is around 6.8 µm thick and covers the vitrified cells. These cells are perfectly suited for further FIB-SEM analysis.

ZEISS Correlative Cryo Workflow at Work

- › In Brief
- › The Advantages
- › **The Applications**
- › The System
- › Technology and Details
- › Service

Cell Biology: Identification of rare event

Spindle pole bodies are difficult to localize within yeast cells. They are small and rarely occurring structures. ZEISS Correlative Cryo Workflow lets you precisely identify and image such cellular structures in the near-to-native state.

The LSM with the Airyscan detector makes the identification of these structures even easier so further details can be imaged. All images – from a large overview of the entire cell to high-resolution images of these tiny structures – are organized in a ZEN Connect project, providing all data needed to re-locate these cellular structures in the FIB-SEM.

Using the Crossbeam, TEM lamella of the identified regions can be prepared for cryo electron tomography. Volume imaging is possible as well. Furthermore, the workflow solution allows you to reconnect all data after image acquisition. Images from the Crossbeam or tomograms from the TEM can be combined with the LSM data and can be rendered in three-dimensional context.

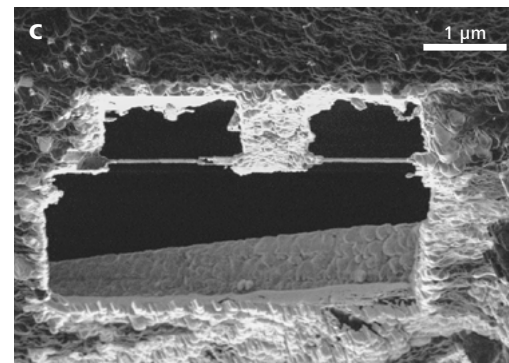

Yeast cells labeled with NUP (nuclear pore complex)-GFP and CNM67-tdTomato. Sample and tomogram courtesy of M. Pilhofer, ETH Zürich, Switzerland

- ZEN Connect movie shows the overlay of an LM and EM dataset – from the grid overview to the region of interest identified for further TEM tomography.
- Early state of the milling process: Lamella is prepared around the marked region which was identified at the LSM.
- FIB image of the prepared lamella; lamella thickness: 230 nm
- 3D overlay of the reconstructed and segmented tomogram with LSM dataset (Spindle pole body is false-colored in cyan); nuclear membrane and microtubules were segmented using IMOD.
- Segmented and reconstructed tomogram

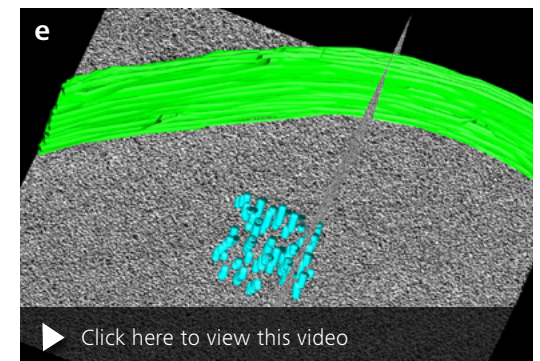
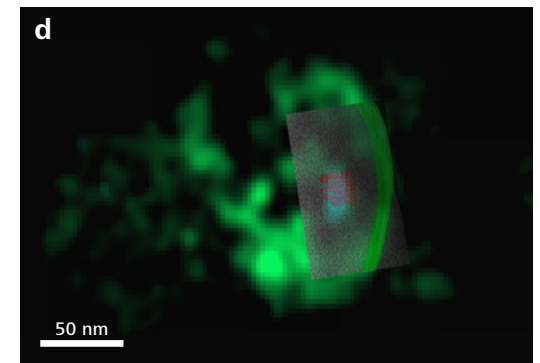
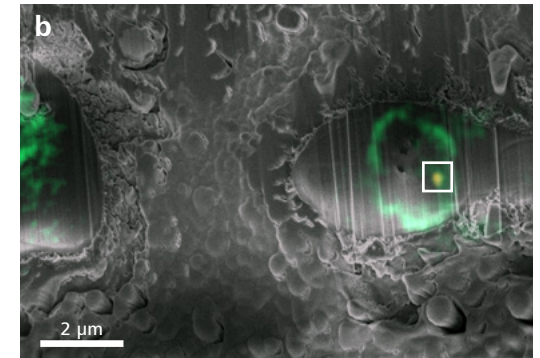

ZEISS Correlative Cryo Workflow at Work

- › In Brief
- › The Advantages
- › **The Applications**
- › The System
- › Technology and Details
- › Service

Cell Biology: Correlative 3D volume imaging

Once cellular structures such as spindle pole bodies are identified in the LSM system, the superior imaging quality of ZEISS Crossbeam allows targeting and analyzing the ultrastructure using cryogenic volume imaging. Even with low acceleration voltages, Crossbeam enables high-contrast imaging of non-stained, vitrified samples while protecting the sample from damage. High-resolution images acquired with the LSM and high-contrast images from the Crossbeam facilitate a precise image overlay. Once the region of interest is relocated in the Crossbeam using ZEN Connect, 3D datasets of the identified cells were acquired. Two spindle pole bodies were targeted within the correlative volume. The orientation of individual microtubules becomes clearly visible in the high-contrast images according to the cutting direction of the FIB. Further cell compartments could be identified in the 3D volume.

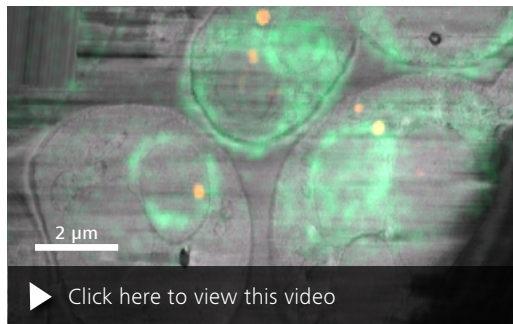

Overlay of a high-resolution LSM/AiryScan image with a high-contrast Crossbeam image acquired under cryogenic conditions. The overlay was done with ZEN Connect.



3D volume reconstruction of yeast cells and segmentation of the nucleus (dark blue) as well as several mitochondria.

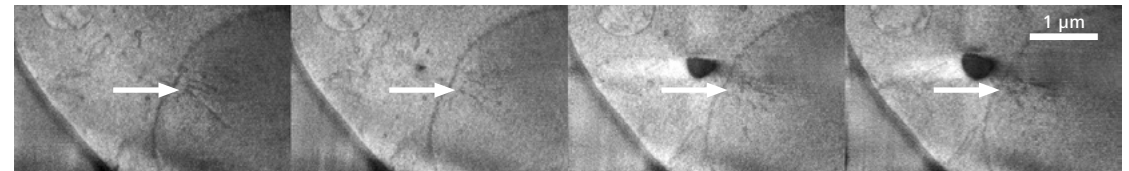

Longitudinally sectioned spindle pole body within the nuclear membrane. Image step size: 50 nm

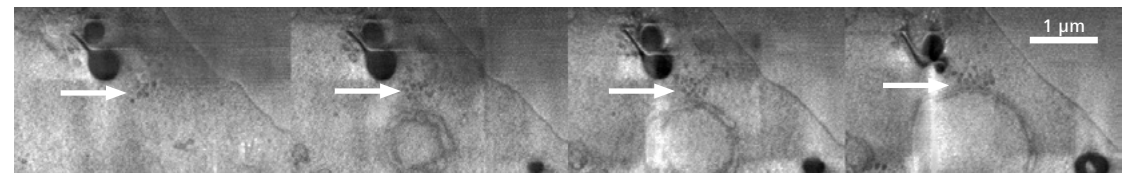

Cross-sectioned microtubules outside the nuclear membrane. Image step size: 50 nm

ZEISS Correlative Cryo Workflow at Work

- › In Brief
- › The Advantages
- › **The Applications**
- › The System
- › Technology and Details
- › Service

Cancer Research

Cancer cells exhibit a strong phenotype towards mitochondrial fission which potentially explains their resistance to drugs.

Chemical fixation methods often create artifacts such as the accumulation of mitochondria which could be misinterpreted as fission events.

Cryo fixation avoids these artifacts and preserves samples in the near-to-native state.

The example shows adenocarcinoma cells plunge-frozen on sapphire disks. LSM data already emphasize a dense mitochondrial network with increased fission subsequently confirmed by the Crossbeam data. After imaging with LSM and Airyscan, the vitrified sample was transferred to the Crossbeam. ZEN Connect was used to relocate the regions of interest, to overlay the respective dataset after acquisition, and to organize all images acquired.

The SmartFIB serial section images were registered and processed using the EM Processing Toolbox.

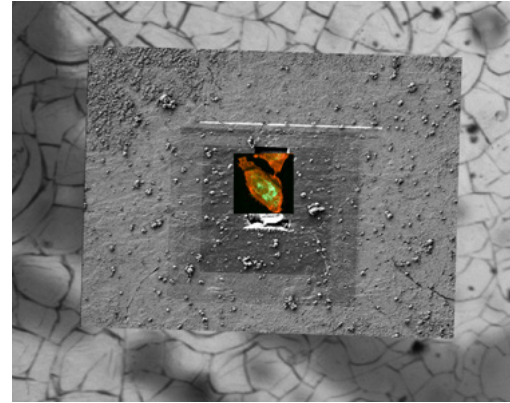

Plunge-frozen adenocarcinoma cells grown on sapphire discs. All regions of interest are shown in context in ZEN Connect.



3D dataset of one adenocarcinoma cell showing the strong mitochondrial fission pattern.

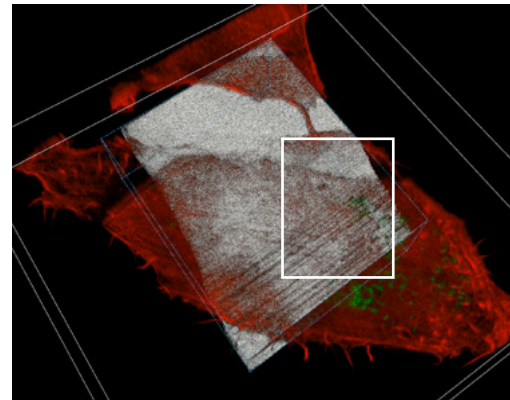

3D Overlay of an LSM volume with a Crossbeam volume.

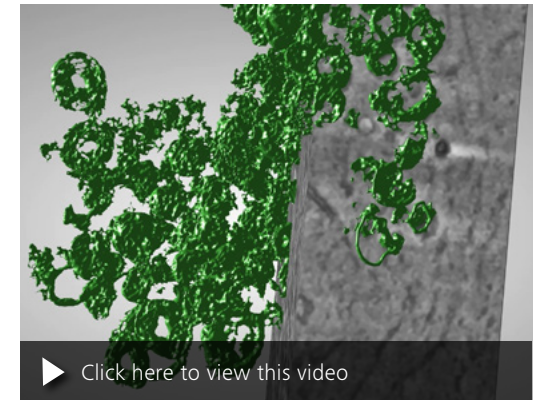

Auto-segmented network of mitochondria in a subvolume of a Crossbeam dataset.

[▶ Click here to view this video](#)

ZEISS Correlative Cryo Workflow at Work

- › In Brief
- › The Advantages
- › **The Applications**
- › The System
- › Technology and Details
- › Service

Plant Science

The response of plants to changing environmental conditions, such as increasing salinity, is an important research topic in plant science. Plants commonly show stress reactions as they cope with these changing conditions. One effect that can be observed on the ultrastructural level is the formation of so-called stromules, long tubular extensions in plastids. The ZEN Connect project shows images of different imaging modalities: LSM was employed to localize stomata and internalized plastids using the autofluorescence of the sample. After successful re-localization of the region of interest, the LSM image was overlaid with an SEM overview image of the selected stoma. A FIB image stack of the stoma was acquired. The EM dataset revealed increased stromule formation in the plastids.

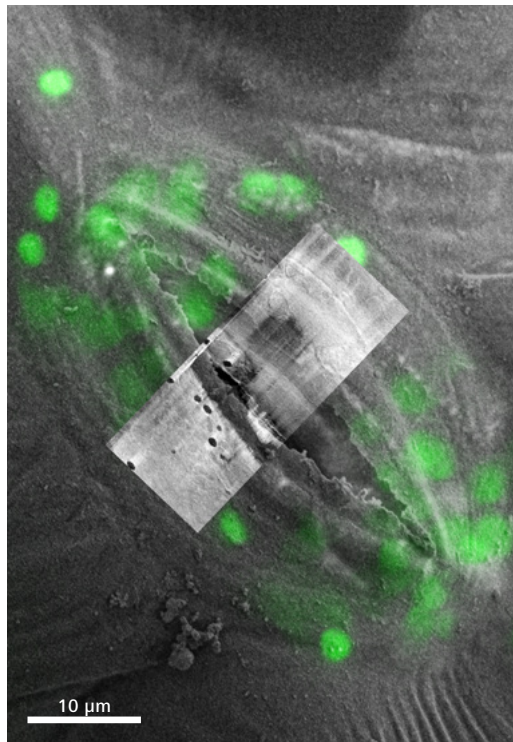

Stomata and internalized plastids were identified with an LSM using the autofluorescence of the sample. The selected stoma was re-located and imaged with the Crossbeam. Sample courtesy: B. Franzisky, University of Hohenheim

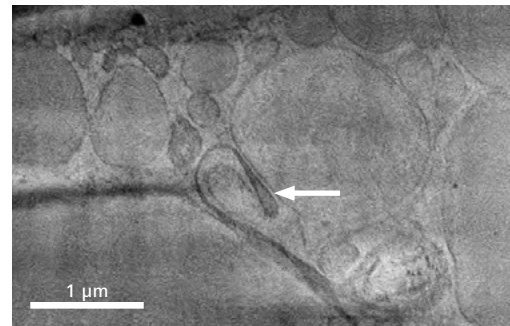

Stromules are clearly visible in the section planes acquired with the Crossbeam.

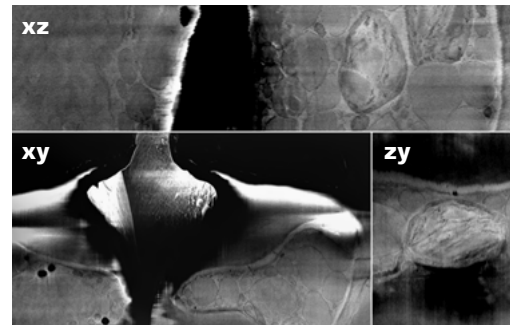
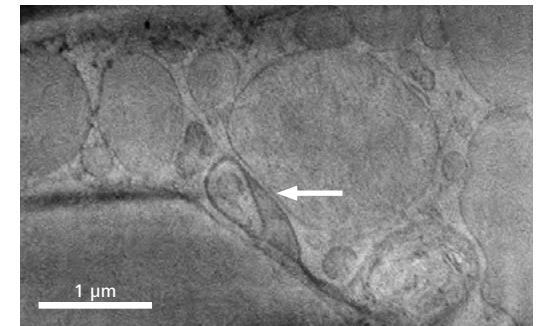

Aligned and processed FIB image stack of the stoma. Different views of the imaged stoma were displayed in the Ortho view.

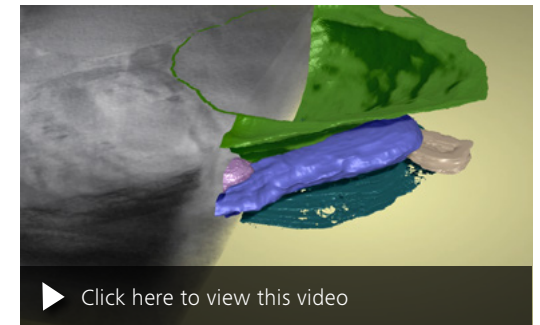

3D reconstruction and segmentation of the FIB image stack reveals the morphology of the plastids. The reconstruction shows stromules closely interacting with mitochondria (nucleus: light green, plastids: blue, mitochondria: pinkish, vacuole: dark green)

ZEISS Correlative Cryo Workflow at Work

- › In Brief
- › The Advantages
- › **The Applications**
- › The System
- › Technology and Details
- › Service

Developmental Biology: Investigation of mitotic cells in *C. elegans*

The *C. elegans* worm is a widely used model organism in developmental biology. However, its embryonic development is rapid – imaging rare or transient features by electron microscopy in such a biological sample is challenging. To capture specific stages of cell replication and cell division processes, one must trap and record these transient structures, then use EM to locate and subsequently image the corresponding volume in the appropriate context of the organism. Crucially, the chitinous layer surrounding the embryo retards aldehyde penetration, necessitating fixation by high-pressure freezing (HPF), meaning that live cell or conventional fixed cell LM screening is not possible.

Whole *C. elegans* worms were fixed by HPF and embryonic cells in metaphase were imaged in situ by cryo-fluorescence microscopy. The screened worms were then heavy-metal stained by freeze substitution, resin-embedded and sectioned so that the same volume could be located and imaged at high resolution, with high contrast, by the Crossbeam. Using this workflow, the targeted metaphase could be successfully reconstructed. Additionally, this approach allowed serendipitous discoveries: an adjacent intriguing punctate fluorescence signal was able to be correlated to a putative autophagosome.

Thus, cryo-fluorescence microscopy of high-pressure frozen thick samples can be used to trap and image transient cellular structures in a near-to-native state; appropriate processing and subsequent correlative volume EM imaging then allows the reconstruction of these targeted architectures at high resolution and in 3D.

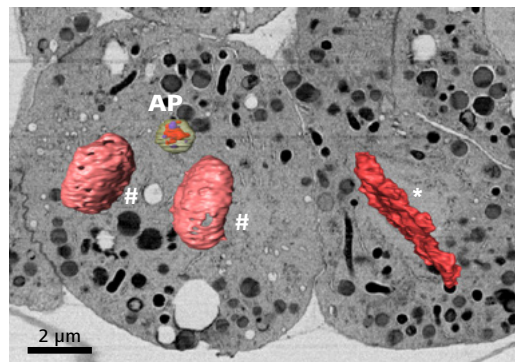

Reconstruction of cellular structures such as an autophagosome (AP) or the genome in different mitotic phases (*cell in metaphase, # cell in telophase).

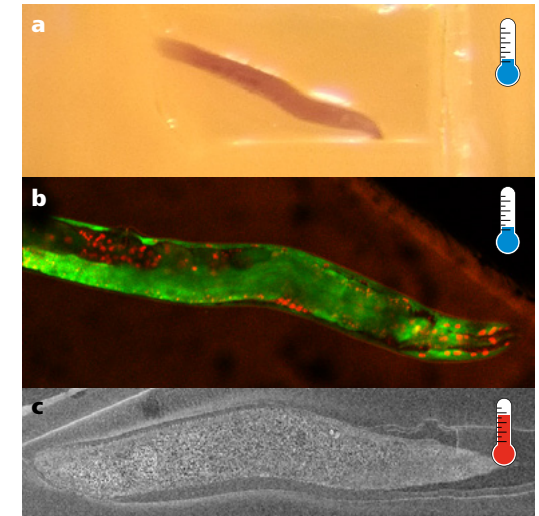
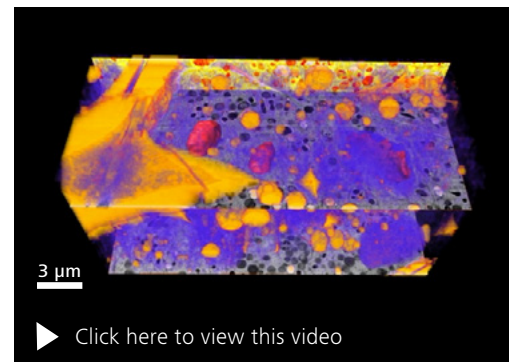

The condensed metaphase genome of an early embryo in a *C. elegans* worm was imaged.

- Overview image of the entire *C. elegans* worm
- The worm was imaged under cryogenic temperature with an LSM/Airyscan system before freeze substitution.
- The embedded and stained worm was then imaged with a Crossbeam.

Courtesy of K. Narayan, National Cancer Institute/NIH and Frederick National Laboratory for Cancer Research, USA

ZEISS Microscopes – Designed to Answer Various Scientific Questions

- › In Brief
- › The Advantages
- › **The Applications**
- › The System
- › Technology and Details
- › Service

ZEISS LSM 900 and 980 with Airyscan 2 are your confocal microscopes for fast and gentle multiplex imaging—also at room temperature. The LSM can be changed quickly from cryo capabilities to a room temperature system for imaging of living or fixed samples, and back again. Experience the full flexibility and usability of the microscope without any compromises. For further information, see the respective product information for ZEISS LSM 900 and ZEISS LSM 980.

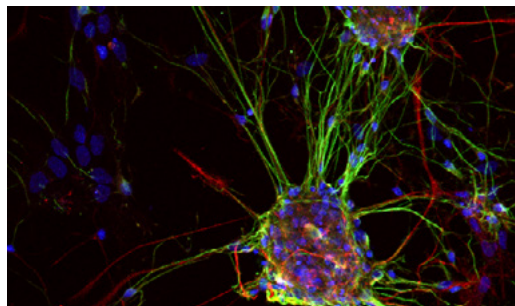

Neurospheres, multi-color label with Dapi (blue), Tubulin-Cy2 (green), DCX-Cy5 (red). Sample courtesy of H. Braun, LSM Bioanalytik GmbH, Magdeburg, Germany.

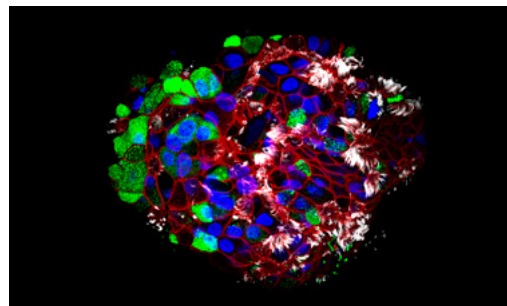

Human Distal Lung Organoid showing club cells and ciliated cells, everted for 10 days. Courtesy of Prof. C. Kuo, Department of Medicine, Hematology Division, Stanford University, USA.

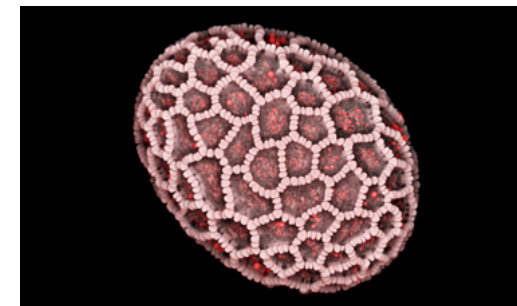

Lilium auratum pollen grain, acquired with Airyscan 2 in Multiplex mode. Image courtesy of J. Michels, Zoological Institute, Kiel University, Germany.

ZEISS Crossbeam gives your 3D work that dynamic edge, whether you are milling or acquiring analytical data. Count on excellent images from any sample thanks to the Gemini electron optics. You will achieve high resolution and contrast while reaping the benefits of high signal-to-noise ratios, right down to very low accelerating voltages – perfect for your sensitive biological samples. For further information see the product information for ZEISS Crossbeam.

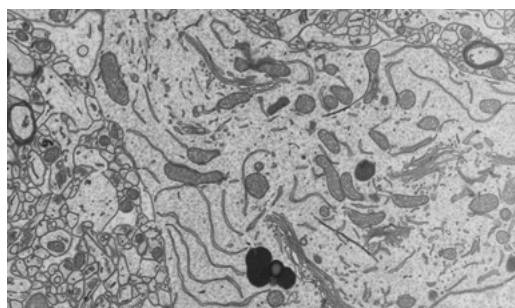

Mouse brain, OTO stained, imaged with Crossbeam 540, Sample courtesy of C. Genoud, FMI, Basel, Switzerland.

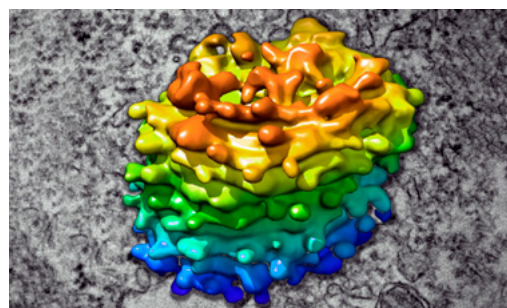

3D reconstruction of algal Golgi body based on FIB-milling raw data. (Blue/green: cis-golgi, yellow/orange: trans-golgi) Image courtesy of Dr. L. Hughes, Oxford Brookes University, UK.

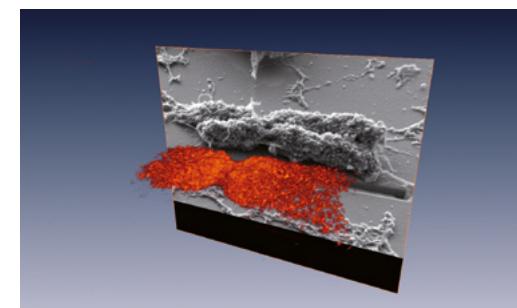

3D reconstruction of chromosomes based on real-time movie. The individual frames were acquired with in-lens SE detector at 2 kV. Courtesy of Prof. G. Wanner, Munich, Germany.

Your Flexible Choice of Components

- › In Brief
- › The Advantages
- › The Applications
- › **The System**
- › Technology and Details
- › Service



Light microscopes

- Widefield systems:
 - Axio Imager.M2, Axio Imager.Z2
- LSM 900 / LSM 980 with Axio Imager.Z2

Additional Hardware Light Microscopy

- Cryo microscopy stage CMS196 set including
 - 3 L auto dewar flask
 - Holder for dewar flask
 - Adapter plate for Axio Imager
 - Stage carrier transmitted light/reflected light
 - Condenser carrier
 - 6× bellows for objectives
 - Control unit for stage
 - Test sample
- For widefield system: Apotome 3 Slider
- For LSM: Airyscan 2



Electron microscopes

- Crossbeam 350
- Crossbeam 550
- Crossbeam 550 L

Additional Hardware Electron Microscopy

- Quorum PP3010Z including:
 - Prepdek® workstation
 - Cryo vacuum transfer device
 - Cryo preparation chamber
 - TEM prep slusher
 - Rotatable cryo substage
- Quorum film monitor (optional)
- Quorum pressurized dewar (optional)

Cryo Accessory Kit

- Correlative Cryo Holder for TEM grids / Sapphire discs
- Correlative Cryo Holder for HPF planchets
- Correlative Cryo Holder for AutoGrid
- Storage box for Correlative Cryo Holder
- Transfer container
- Precision tweezers
- Loading station
- Various adapters for Correlative Cryo Holders
- Various shuttles for the Quorum system
- Quorum Perspex Lid
- Magnifying binocular telescope loupe

Software

- ZEN Imaging Software (blue edition)
- ZEN SEM

Mandatory modules:

- ZEN Connect
- ZEN 3DxI/3DxI+
- SmartSEM including Smart FIB

Recommended modules:

- ZEN EM Processing Toolbox
- Cryo Drift Reduction Module

ZEISS Correlative Cryo Workflow: System Overview

- › In Brief
- › The Advantages
- › The Applications
- › **The System**
- › Technology and Details
- › Service

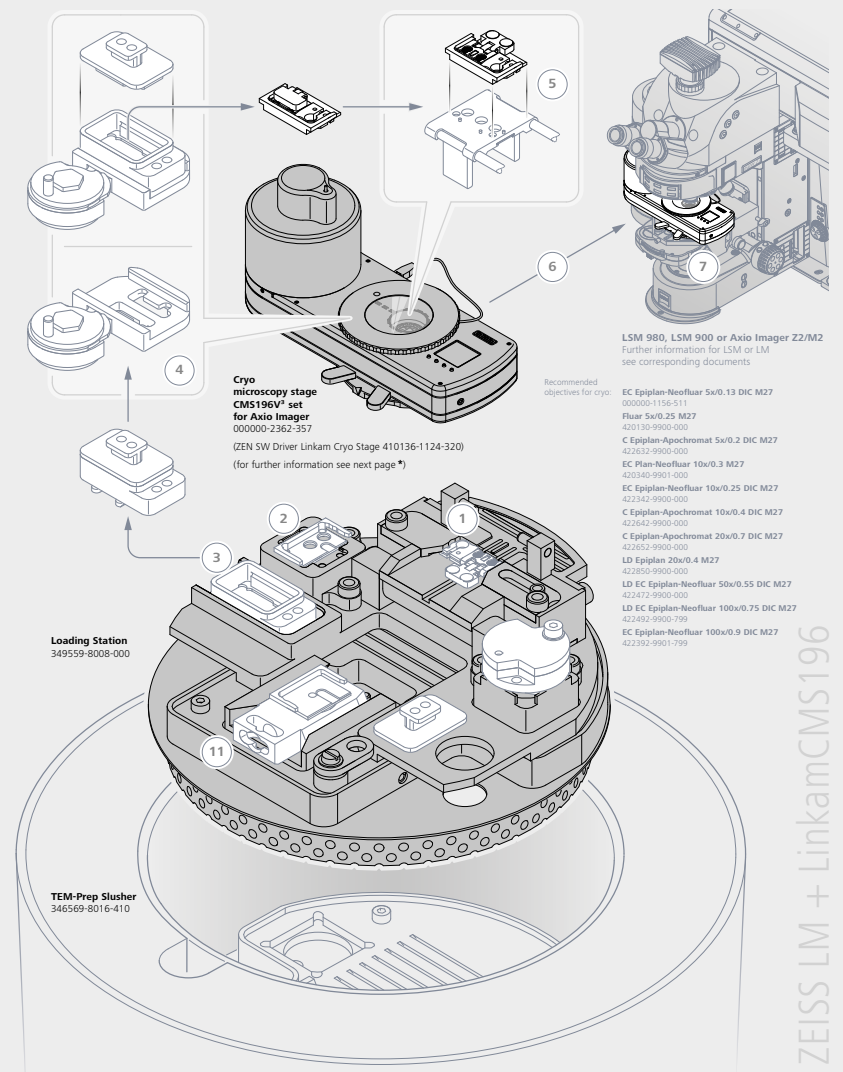
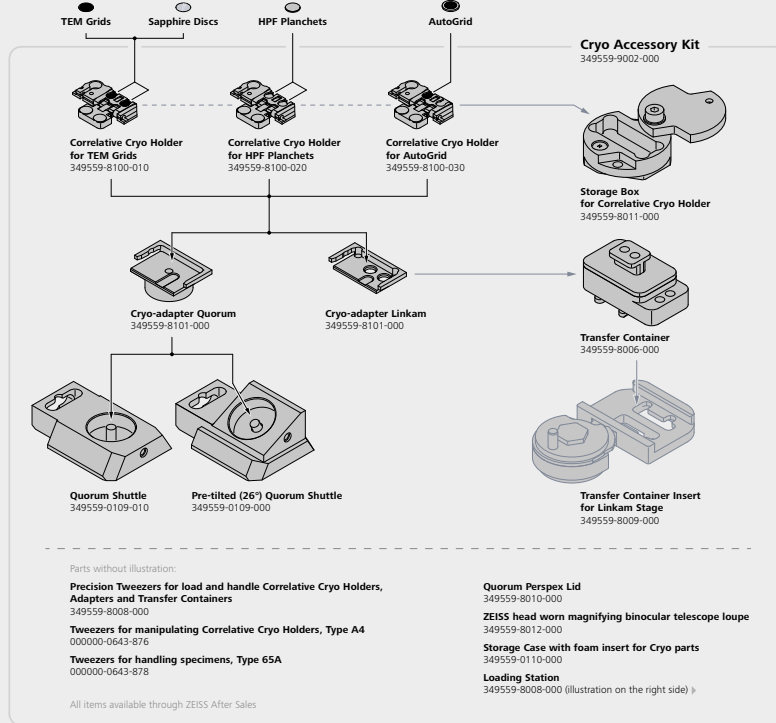

The Correlative Cryo Workflow

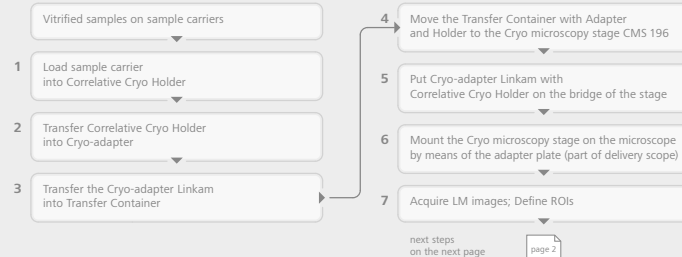

ZEISS LM + LinkamCMS196

ZEISS Correlative Cryo Workflow: System Overview

- › In Brief
- › The Advantages
- › The Applications
- › **The System**
- › Technology and Details
- › Service

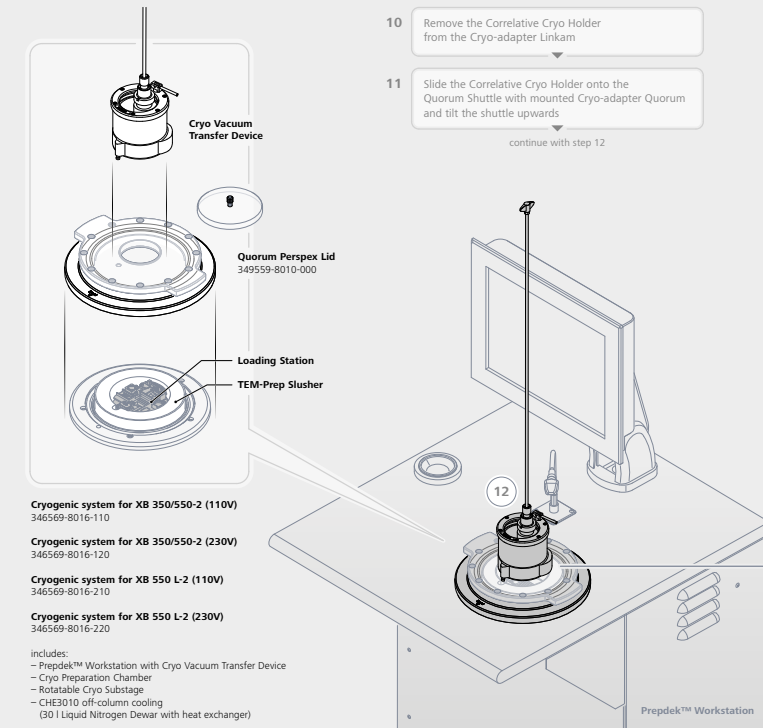
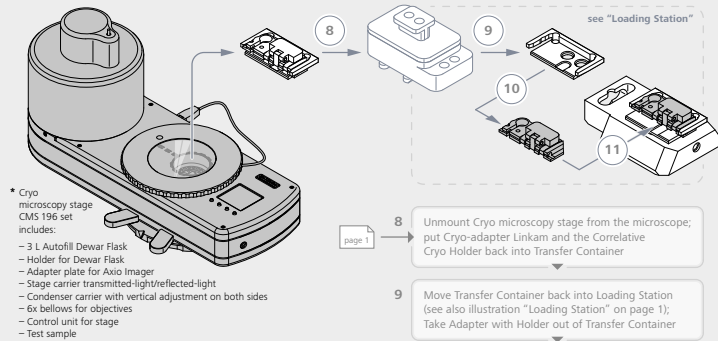

ZEISS Crossbeam + Quorum PP3010Z

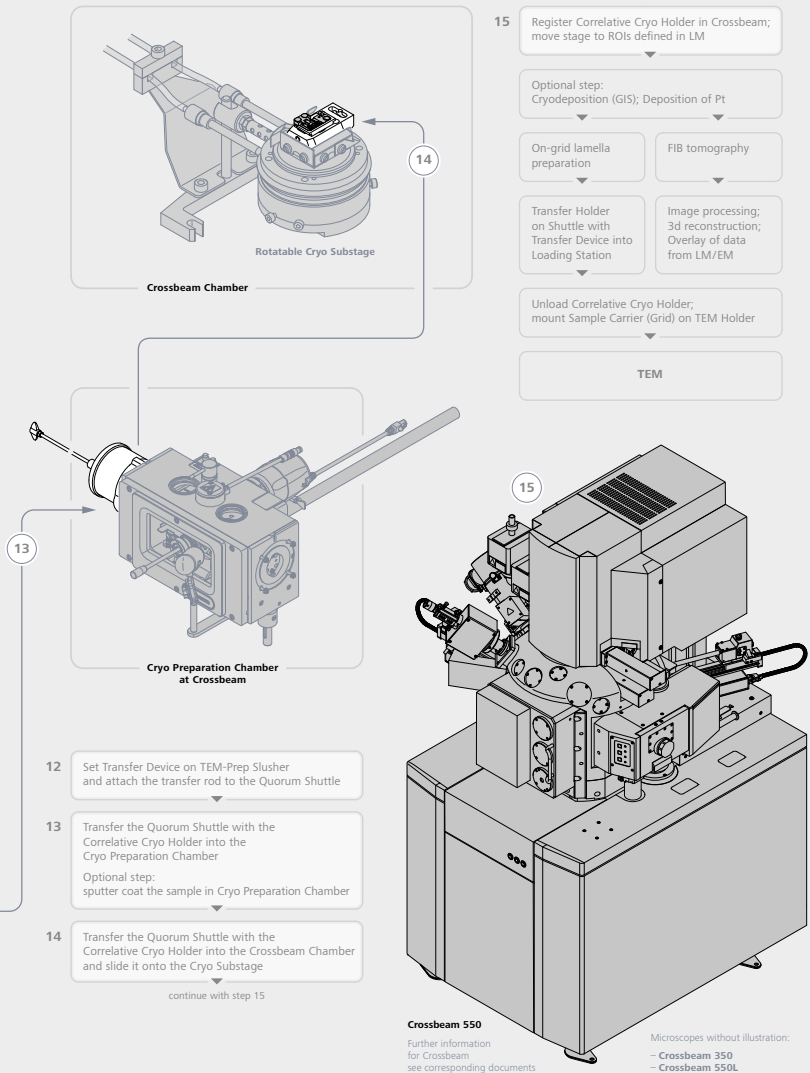

Technical Specifications

- › In Brief
- › The Advantages
- › The Applications
- › The System
- › **Technology and Details**
- › Service

Microscopes		
Widefield microscope	Axio Imager M.2 / Z.2 (optional with Apotome 3)	
Confocal laser scanning microscope	LSM 900 / LSM 980 / with Airyscan 2	
Focused ion beam electron microscope	Crossbeam 350, 550, 550L	
Recommended conditions for optimal results of the Correlative Cryo Workflow		
Full compliance with the installation requirements for LM/LSM and Crossbeam		
Humidity	Ideally 40% or less	
Lab space for EM	Ideally 4 m × 6 m	
Lab space for LM	Ideally 2 m × 3 m	
	LM and EM systems ideally in close proximity to each other and with sufficient air ventilation to allow work with liquid nitrogen	
Cryo Accessory Kit		
Correlative Cryo Holder	For TEM Grids and Sapphire Discs	2 grids or sapphire disks / holder
		Diameter 3.05 mm, with max thickness of 180 µm
	For HPF Planchets	2 planchets / holder
		Diameter 3.05 mm, with a height of 500 µm
	For AutoGrid	1 AutoGrid / holder
Head-worn magnifying loupe	4.3× magnification at 400 mm focal distance	

Technical Specifications

- › In Brief
- › The Advantages
- › The Applications
- › The System
- › **Technology and Details**
- › Service

Cryo-related Hardware for Light Microscopy				
Cryo microscopy stage CMS196V ³ set for Axio Imager	Travel range X, Travel range Y	10.8 mm, 2.8 mm		
	Resolution XY, Repeatability XY, Accuracy XY	1 µm, 3 µm, 5 µm		
	Min speed, Max speed	1 µm/s, 2000 µm/s		
	Measuring system	Self-referencing		
	Hold temperature @ bridge	−195 °C		
	Cool-down time	5 min		
	Integrated LN dewar hold time	28 min		
	LN external (3L) Autofill dewar hold time	240–360 min		
Airyscan 2 for LSM 900/980	FWHM XY/Z resolution	WD (mm)	Airyscan SR (nm)	MPLX SR 4Y (nm)
	LD EC Epiplan-Neofluar 100×/0.75 DIC M27	4	290/1150	290/1300
	EC Epiplan-Neofluar 100×/0.9 DIC M27	1	250/750	250/850
Objectives suitable for cryo microscopy	EC Epiplan-Neofluar 5×/0.13 DIC M27			
	Fluar 5×/0.25 M27 (for widefield imaging)			
	C Epiplan-Apochromat 5×/0.2 DIC M27			
	EC Plan-Neofluar 10×/0.3 M27			
	EC Epiplan-Neofluar 10×/0.25 DIC M27			
	C Epiplan-Apochromat 10×/0.4 DIC M27			
	C Epiplan-Apochromat 20×/0.7 DIC M27			
	LD Epiplan 20×/0.4 M27 (for widefield imaging)			
	LD EC Epiplan-Neofluar 50×/0.55 DIC M27			
	LD EC Epiplan-Neofluar 100×/0.75 DIC M27			
EC Epiplan-Neofluar 100×/0.9 DIC M27				

Technical Specifications

- › In Brief
- › The Advantages
- › The Applications
- › The System
- › **Technology and Details**
- › Service

Cryo-related Hardware for Electron Microscopy		
Quorum PP3010Z		
Port usage of cryo system	VP port for cryo feed-throughs	
	MultiGIS port for Cryo Preparation Chamber on Crossbeam 350 & 550	
	Cryo port (52 mm MP port 2) for Cryo Preparation Chamber on Crossbeam 550L	
Number of N₂ cooling lines	3 (Cryo Preparation Chamber, SEM Cryo Stage, SEM Anticontaminator)	
Purity of N₂ supply for cooling the system at least 24 h	5.5 (99.9995 %)	
Recommended temperature settings	Prep stage/SEM stage	< -150 °C
	Anticontaminator prep stage / Anticontaminator SEM	< -180 °C
Gas flow rates/gas consumption (cryo stage, Anticontaminator and preparation chamber)	1–5 l/min (manual) or auto adjust/max. 15 l/min	
Drift	At room temperature	< 7 nm/min
	90 min after cooling the stage (-160 °C) with drift reduction option	< 20 nm/min
	120 min after cooling the stage (-160 °C) without drift reduction option	< 50 nm/min
Min. Temperatures	Gas cooled rotate stage (SEM)	down to -175 °C
	Anticontaminator (SEM)	down to -190 °C
	Stage (preparation chamber)	down to -190 °C
	Anticontaminator (preparation chamber)	down to -190 °C
	Stability of temperatures	< 0.5 °C
Capacity of heat exchange dewar	30 liter LN ₂ (for cooling the system 20 h at -150 °C for stages and -180 °C for anticontaminators), refill during operation possible	
Sample manipulation in preparation chamber	Sample fracture	Built-in knife
	Sample sublimation	Control of temperature by built-in heater
	Sputter coating with Platinum in Argon atmosphere	Ar gas supply: 0.7 bar, Purity 6.0 (99.9999 %)
EM pressurized dewar (optional)		
For supply of dry nitrogen gas for EM cryo system	60 liter LN ₂ capacity	
	2–3 bar gas pressure	
	24 h gas supply for cooled operation of EM cryo system with up to 15 liter N ₂ /min	

Technical Specifications

- › In Brief
- › The Advantages
- › The Applications
- › The System
- › **Technology and Details**
- › Service

Operating Software		
Crossbeam	SmartSEM 6.08 or higher	Easy to use control interface for Crossbeam
		Enables image acquisition and complex FIB-SEM workflows via the integrated SmartFIB interface
	ZEN 3.3 SEM	Basis software for usage of correlative modules on the SEM
		Allows image acquisition on the SEM
		Required for ZEN Connect modules on the SEM
		Contains ZEN Connect basic functionality
Widefield system	ZEN pro 3.3 or higher	Image acquisition and processing software for light microscopes except laser-based 3D systems
LSM	ZEN system 3.3 or higher	Image acquisition and processing software for light microscopes including laser-based 3D imaging systems
Offline Workstation	ZEN desk 3.3 or higher	Software supporting offline analysis, processing and visualization
Operating Software (3 rd party components)		
Quorum PP3010Z	aQuilo 1.0.32 or higher	Software to control the Quorum PP3010Z cryo system
		Allows read out of temperatures into SmartSEM to
		<ul style="list-style-type: none"> ■ enable safe specimen transfer ■ inhibit chamber ventilation at cold stage ■ reduce drift ■ document temperature values with the saved images
Linkam CMS196V ³	ZEN SW Driver Linkam Cryo Stage	ZEN software driver to operate the cryo microscopy stage CMS196V ³
		Synchronous and asynchronous temperature logging; x, y-positioning of the sample
		Parcentricity Wizard

Technical Specifications

- › In Brief
- › The Advantages
- › The Applications
- › The System
- › **Technology and Details**
- › Service

Software Modules for Correlative Microscopy		
ZEN Connect	Correlative workspace	<ul style="list-style-type: none"> ■ Comprehensive, sample-centric correlative environment to handle multiscale and multimodal images. ■ Import and combine data from any image source in ZEN. ■ Zooming from the full macroscopic view of the sample down to nanoscale details. ■ Viewing of multiple layers with transparency including display of current stage position and field of view. ■ Manual alignment of images to allow for correction of xy-shift, rotation, re-scaling, shearing and mirroring. ■ Point alignment of images to calculate xy-shift, rotation, re-scaling, shearing and mirroring. ■ Efficient stage navigation and correlation of images
	Data management	<ul style="list-style-type: none"> ■ Import of any microscope image including the metadata as supported by Bio-Formats (A list of supported formats can be found at: https://www.openmicroscopy.org/bio-formats/) ■ Automatic file labeling ■ Project-based file architecture ■ Filter search functionality using metadata
ZEN Connect 2D Add-on		<ul style="list-style-type: none"> ■ Semiautomatic calibration of sample holders for correlative microscopy ■ Definition of regions of interest in the correlative workspace ■ Easy retrieval of marked regions ■ Only needed on image acquisition workstations
ZEN Connect 3D Add-on		<ul style="list-style-type: none"> ■ Control of the displayed z-position in ZEN Connect for single images and the global project ■ Alignment of images in z-dimension and 3D rotation ■ Viewing of two 3D stacks 3Dxl module required ■ Import of FIB stacks
3Dxl/3Dxl+		<ul style="list-style-type: none"> ■ ZEN module for the visualization of 3D/4D image stacks
Recommended Modules for the Correlative Cryo Workflow		
Cryo Drift Reduction for Crossbeam		Software to reduce stage drift (optional licence to SmartSEM 6.08) < 20 nm/min (90 min after cooling the stage (-160 °C))
EM Processing Toolbox		ZEN module for processing EM images: <ul style="list-style-type: none"> ■ Import TIFF stacks acquired with SmartFIB in ZEN ■ Processing functions to improve image quality and reduce imaging artifacts such as noise and stripes ■ Coarse manual and automatic z-stack alignment ■ Replace individual slices of poor quality with predecessor/successor ■ Cut out free-form ROIs for better visualization

Count on Service in the True Sense of the Word

- › In Brief
- › The Advantages
- › The Applications
- › The System
- › Technology and Details
- › **Service**

Because the ZEISS microscope system is one of your most important tools, we make sure it is always ready to perform. What's more, we'll see to it that you are employing all the options that get the best from your microscope. You can choose from a range of service products, each delivered by highly qualified ZEISS specialists who will support you long beyond the purchase of your system. Our aim is to enable you to experience those special moments that inspire your work.

Repair. Maintain. Optimize.

Attain maximum uptime with your microscope. A ZEISS Protect Service Agreement lets you budget for operating costs, all the while reducing costly downtime and achieving the best results through the improved performance of your system. Choose from service agreements designed to give you a range of options and control levels. We'll work with you to select the service program that addresses your system needs and usage requirements, in line with your organization's standard practices.

Our service on-demand also brings you distinct advantages. ZEISS service staff will analyze issues at hand and resolve them – whether using remote maintenance software or working on site.

Enhance Your Microscope System.

Your ZEISS microscope system is designed for a variety of updates: open interfaces allow you to maintain a high technological level at all times. As a result you'll work more efficiently now, while extending the productive lifetime of your microscope as new update possibilities come on stream.

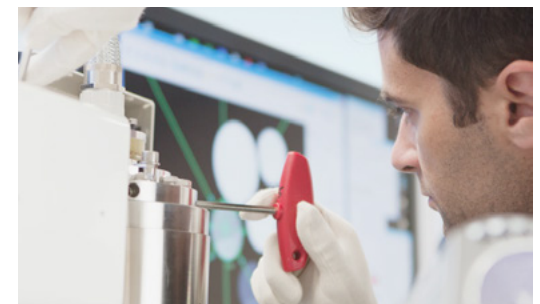

Profit from the optimized performance of your microscope system with services from ZEISS – now and for years to come.

>> www.zeiss.com/microservice



Carl Zeiss Microscopy GmbH
07745 Jena, Germany
microscopy@zeiss.com
www.zeiss.com/cryo