



## **ZEISS Axioscope 5**

Your Smart Microscope for Biomedical Routine and Research

[zeiss.com/axioscope](https://zeiss.com/axioscope)



Seeing beyond

# Your Smart Microscope for Biomedical Routine and Research

- › **In Brief**
- › The Advantages
- › The Applications
- › The System
- › Technology and Details
- › Service

In your clinical lab, such as a pathology lab, smart features and ergonomic handling are particularly valuable. Adaptable accessories such as ergophototubes further enhance your comfort and reduce strain during work. While working with Axioscope 5 you don't even need to move your hands from the microscope stand anymore. All you have to do is focus and press Snap. You're done. This allows you to fully concentrate on analyzing and documenting your samples. You'll work more efficiently, save time and produce high contrast images with best image quality. What's more: this even works without any PC involved.



# Simpler. More Intelligent. More Integrated.

- › In Brief
- › **The Advantages**
- › The Applications
- › The System
- › Technology and Details
- › Service

## Capture Four Fluorescence Channels with Just One Click

Acquiring fluorescent images has never been so easy. Combine Axioscope 5 with the high performance LED light source Colibri 3 and the stand-alone microscope camera Axiocam 202 mono to have the perfect setup for easy multichannel fluorescence documentation. Switch effortlessly between the channels for UV, blue, green and red excitation. Just select the relevant channels and press Snap. The system then takes over and automatically adjusts the exposure time, acquires the image, switches the channel and starts again. That's it: you get your overlaid multichannel fluorescence image including scale bar – even without a PC.

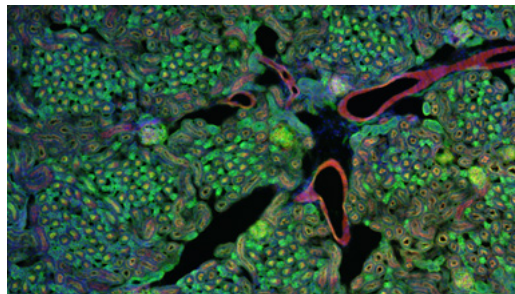

▶ [Click here to view this video](#)

## Smart Microscopy Makes Your Digital Documentation Faster

Axioscope 5 makes documenting your specimens very efficient. The color impression shown up in the camera image is exactly the same as it appears through the eyepieces. The smart microscope systems make automatic adjustments for brightness and white balance to keep digital documentation easy. All you have to do is focus on your sample, press the ergonomic Snap button on the microscope, and that's it. Acquiring high quality images with high color fidelity has never been easier – and faster.



## Enhance Ergonomics in Your Clinical Lab

Maintaining a healthy and relaxed working environment is crucial, especially during long work shifts. Axioscope 5 is designed with ergonomics at the forefront, ensuring comfort and efficiency. The microscopes feature an adjustable ergophototube, allowing you to modify the eyepiece height and angle to match your natural posture. All essential buttons and controls are within easy reach, reducing the risk of repetitive strain injuries. The light manager automatically adjusts the illumination to provide uniform brightness at all magnifications. You don't need to manually adjust lamp brightness, saving time and reducing eye fatigue. The transmitted white light LED provides powerful illumination with high color fidelity. Additionally, LED illumination offers stable color temperature, low energy consumption, and a long lifetime, making it both an efficient and cost-effective choice.



# Expand Your Possibilities

- › In Brief
- › **The Advantages**
- › The Applications
- › The System
- › Technology and Details
- › Service

## Boost your Efficiency – with Smart Microscopy

Efficiency and quality are key in your lab, but it can take a lot of time to acquire detail-rich, true-color images. You know the drill: place the sample, focus your region of interest, switch to the computer, adjust settings such as white balance, exposure time and gain, then acquire an image, insert a scale bar, switch back to the microscope ... and so on. That's what a typical documentation workflow looks like.

Now, with Axioscope 5, you can stay focused on your sample at all times, thanks to smart microscopy. Digital documentation is inherent in the systems design. Just press the ergonomic Snap button on the microscope and you're done. The procedure integrates perfectly with your established microscopy workflow and boosts your efficiency tremendously.

### Routine imaging workflow



Smart functionality for digital documentation in brightfield and fluorescence for routine applications.

### Efficiency gain:

Eyes and hands stay on the microscope.



# Expand Your Possibilities

- › In Brief
- › **The Advantages**
- › The Applications
- › The System
- › Technology and Details
- › Service

## This is Smart Microscopy – Digital Documentation Made Easy

Used in combination with the microscope cameras Axiocam 202 mono or Axiocam 208 color, you have the full advantage of a smart standalone microscope solution.

Camera settings such as white balance, contrast and exposure time are done automatically. Without needing additional imaging software or even a computer, you can:

- Snap images and record videos directly from your stand
- Use mouse (and optionally keyboard) to control your camera via OSD (on screen display)
- Save settings
- Store images with all metadata of the microscope and camera as well as scaling information
- Predefine the name or rename your image

### Stand-alone for Basic Routine Imaging



ZEISS Axioscope 5 operates independently of a computer system.

### ZEISS Labscope for Advanced Routine Imaging



Operating ZEISS Axioscope 5 with ZEISS Labscope imaging software is ideal for connected microscopy and standard multichannel fluorescence imaging.

### ZEISS ZEN for Research Applications



Use ZEN imaging software to perform advanced imaging tasks with ZEISS Axioscope 5.



# Expand Your Possibilities

- › In Brief
- › **The Advantages**
- › The Applications
- › The System
- › Technology and Details
- › Service

Whether unstained cells, histologically stained sections, or other samples: transmitted light techniques continue to be the standard for many examinations.

With Axioscope 5 you can use a sheer variety of contrasting techniques for your applications: the classical methods of brightfield, darkfield, phase contrast, but also Differential Interference Contrast (DIC) and polarization contrast. Axioscope 5 can also be equipped with PlasDIC, the cost effective interference contrasting technique.

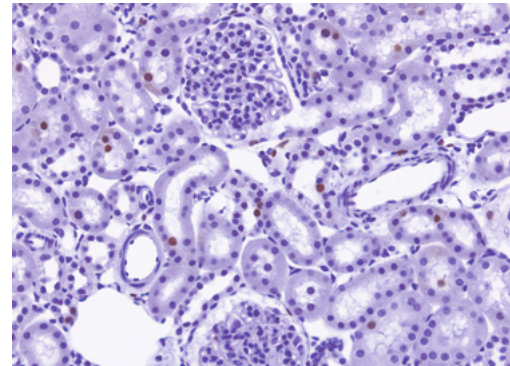

*Rat kidney, acquired in transmitted light brightfield, objective: Plan-Apochromat 20x/0.8*

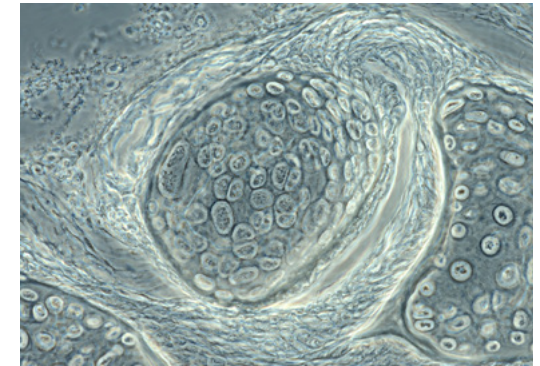

*Trout cartilage acquired in phase contrast, objective: Plan-Apochromat 63x/1.4*

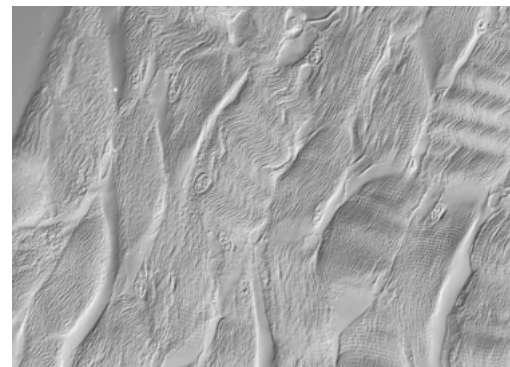

*Rabbit muscle, acquired in DIC contrast, objective: Plan-Apochromat 63x/1.4*

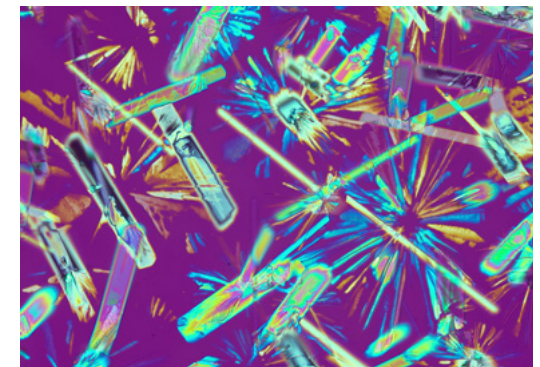

*Crystal, acquired in polarization contrast, objective: Plan-Neofluar 20x/0.8*

# Expand Your Possibilities

- › In Brief
- › **The Advantages**
- › The Applications
- › The System
- › Technology and Details
- › Service

## ZEISS Colibri 3 LED Illumination

Complement your Axioscope 5 with the optional fluorescence LED illumination Colibri 3, and acquire brilliant fluorescence images with ease. Colibri 3 delivers the right wavelength and intensity to excite fluorescent dyes and proteins in a gentle way.

- Save time and money thanks to the long LED lifetime and adjustment-free operation.
- Choose up to four configurable wavelengths to fit your needs. Upgrade anytime you need to.
- Individually control and switch between channels for UV, blue, green and red excitation – or use selected wavelengths simultaneously.
- With direct visual status feedback, you are always sure which FL-LED is in use.
- The integrated design saves space and makes for easy and ergonomic operation.

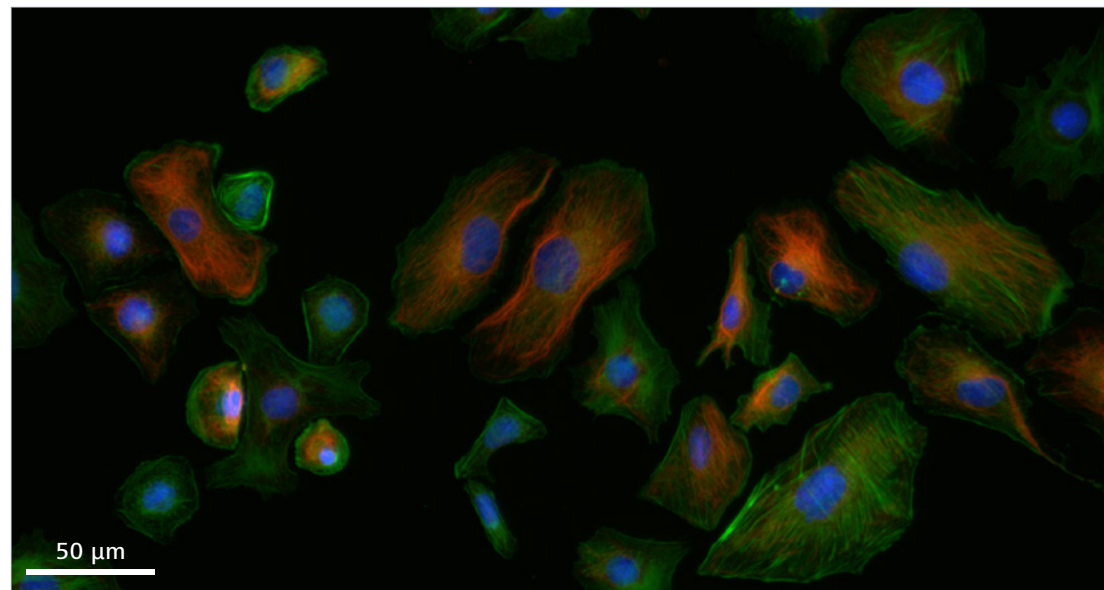

*Mink Uterus Endometrium Epithelial Cells, vimentin – red, F-actin – green, nucleus – blue; acquired with ZEISS Axioscope 5, Colibri 3 and Axiocam 202 mono in stand-alone mode, objective: Plan-Apochromat 40x/0.95*

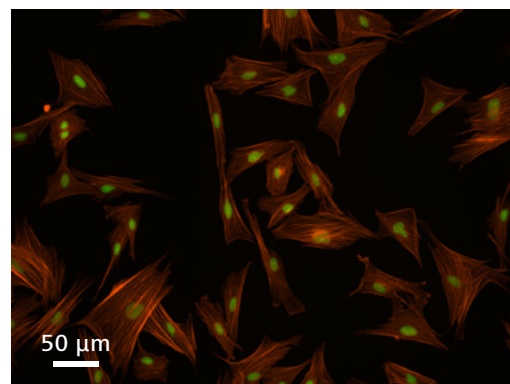

*Indian muntjac, fibroblasts, F-actin – red, nucleus – green objective: Plan-Apochromat 20x/0.8*

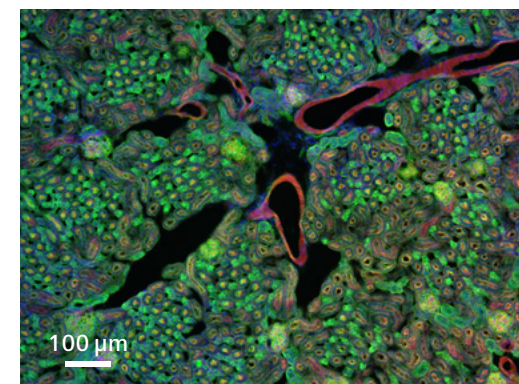

*Mouse kidney in fluorescence, cryosection, AF 488 – WGA, AF 568 Phalloidin, DAPI, objective: Plan-Apochromat 20x/0.8*

# Expand Your Possibilities

- › In Brief
- › **The Advantages**
- › The Applications
- › The System
- › Technology and Details
- › Service

## Stay Relaxed and Protect Your Health

In your clinical or biomedical lab you quickly evaluate the status of tissue to decide on further treatment. You regularly check a huge amount of tissue slides under time pressure. Speed is essential. This work can be tiresome as you sit the whole day in front of your microscope. Therefore, a comfortable and relaxed sitting position is key. All microscope controls need to be ergonomic and comfortable. And fit perfectly to your person.

- Use adaptable ergophototubes to maintain an upright body posture.
- Adjust the height of the stage drive to let your hands rest comfortably on the table. Fine-tune the stage friction control for smoother movements with minimal.
- With ergonomically positioned snap buttons you acquire images and videos directly from the stand.
- Use ECO mode and your microscope goes to standby after being idle for 15 minutes. This saves energy and extends the lifetime of the illumination.
- The active light manager memorizes the individually set light intensity per objective. You profit from uniform brightness at all magnifications and reduced eye.
- With a field of view of 25 mm you see a >20 % larger area compared to conventional 22 mm.
- With the 10 W LED you visualize and document your samples in natural colors where even subtle color differences are clearly visible.

## Choose between two Ergotubes:



Ergophototube with 23 mm FOV and a tilting range from  $-2$  to  $+28^\circ$ .



Ergophototube with 25 mm FOV and a tilting range from  $-2$  to  $+28^\circ$ . Also suitable for coobservation setups.

## How to Adjust Your Microscope for Ergonomic Use



[Click here to view this video](#)



# Expand Your Possibilities

- › In Brief
- › **The Advantages**
- › The Applications
- › The System
- › Technology and Details
- › Service

## Collaborate, Discuss, Share: Co-observation Systems for Simultaneous Use by Multiple Viewers

Multidiscussion or co-observation systems are indispensable tools for lab training, consultation and education. Imagine you have an interesting structure in your pathological sample, where you need a second opinion or advice. Or you educate your students on different types of blood cells where you need to see the same image simultaneously. Experience a new way of flexibility with the active two-position co-observation unit, available with your Axioscope 5. It allows you to arrange your setup in either a front-to-back or

side-by-side configuration (left or right), providing a space-saving solution that adapts to your specific room or table requirements. The homogeneously illuminated field of view and the consistent image brightness for main and co-observer ensures optimal visibility and a comfortable and productive workplace environment. The system is equipped with a light pointer that allows you to highlight interesting details in the specimen. Choose from a range of colors, including white, blue, green, and red, to ensure optimum visibility

under all circumstances. For larger multidiscussion solutions up to 20 co-observers, ZEISS provides various setup options tailored to your specific space requirements. All your colleagues can enjoy a consistent viewing experience, seeing images in the same orientation and brightness as you. This eliminates any potential irritation caused by rotated or mirrored images. In addition, each observation tube is equipped with its own support and height adjustment feature, which guarantees a stable and robust setup.

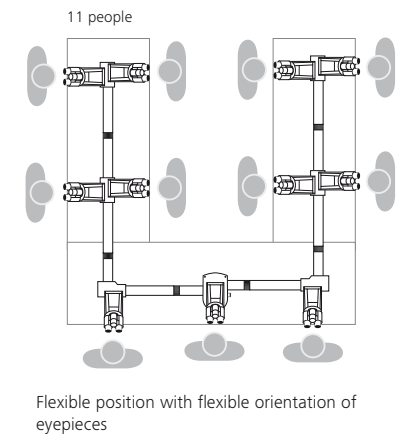
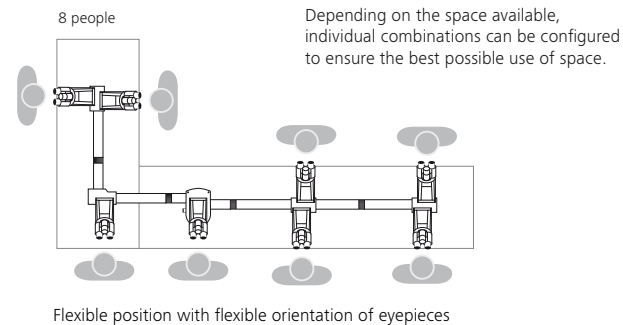
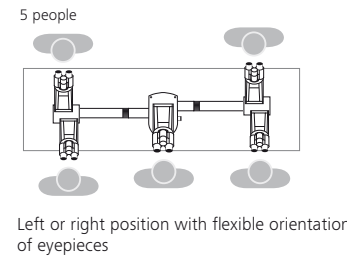
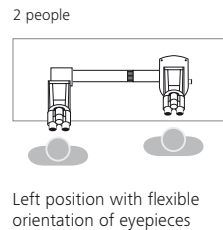
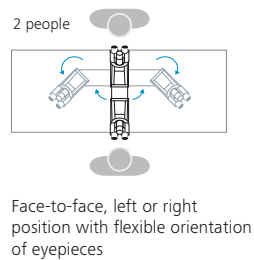

# Tailored Precisely to Your Applications

- › In Brief
- › The Advantages
- › **The Applications**
- › The System
- › Technology and Details
- › Service

Field of Application	Biomedical Research	Human & Veterinary Medicine	Microbiology	Plant Sciences & Botany	Forensics
<b>General task</b>	Neuroscience, developmental biology, molecular biology, genetics, cell biology	Anatomy, pathology, cytology, hematology, cytogenetics, zoology	Bacteriology, mycology, parasitology, virology	Plant anatomy, plant disease, plant development, molecular genetics, epigenetics	Pathology, trace evidence, DNA laboratory
<b>Tests performed</b>	Documentation, answer research questions	Find medical evidence, answer research questions	Find medical evidence	Find quality-related evidence, answer research questions	Find jurisdictional evidence
<b>Typical samples</b>	Tissue, cells, organisms, body fluids	Histological tissue, body fluids like urine, blood, sputum	Bacteria, virus, fungi, parasites	Plant cells, algae, sections, bacteria, fungi, genetically modified crops	Tissue sections, fibers, hair, paint, vaginal swaps, sperm
<b>Common stainings/ preparations</b>	Native, immuno-fluorescence, H&E, FISH	H&E, IHC, Papanicolaou, Giemsa, FISH	Gram stain, acidic-fast stain, methylene blue, Ziehl-Neelsen, immunofluorescence	Safranin & Alcian Blue, Safranin & Fast Green; Etzold	H&E, IHC, immuno-fluorescence such as Sperm Hy-Liter
<b>Typical contrasting techniques</b>	Brightfield, phase contrast, DIC, fluorescence	Brightfield, phase contrast, fluorescence, simple polarization	Brightfield, darkfield, phase contrast, DIC, fluorescence	Brightfield, phase contrast, polarization, DIC, fluorescence	Brightfield, phase contrast, polarization, fluorescence

# Your Flexible Choice of Components

- › In Brief
- › The Advantages
- › The Applications
- › **The System**
- › Technology and Details
- › Service

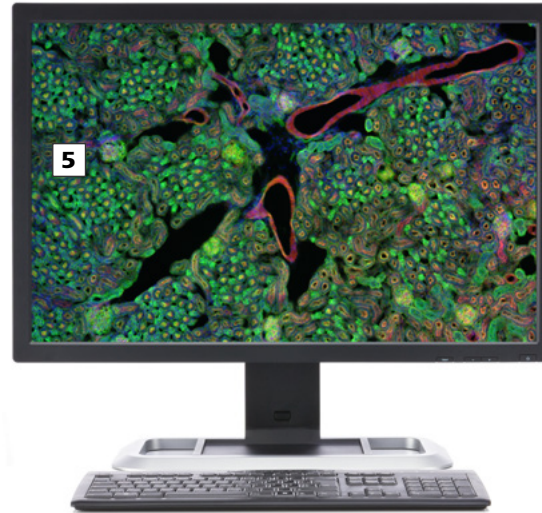

## 1 Microscope

- ZEISS AxioScope 5, transmitted light, LED
- ZEISS AxioScope 5, transmitted light, Hal 50
- ZEISS AxioScope 5, fluorescence

## 2 Recommended Objectives

- Plan-Apochromat
- Plan-Neofluar
- N-Achroplan

## 3 Illumination

Transmitted light:

- LED 10W, Hal 50, Hal 100

Reflected light, fluorescence:

- Colibri 3, HXP 120, and other

## 4 Recommended Microscope Cameras

- ZEISS AxioCam 202 mono
- ZEISS AxioCam 208 color

## 5 Software

- Stand-alone
- Labscope imaging software
- ZEN imaging software

## 6 Accessories

- Ergophototube with 23 mm FOV
- Ergophototube with 25 mm FOV
- Dual observation and multidiscussion units

# System Overview

- In Brief
- The Advantages
- The Applications
- The System
- Technology and Details
- Service

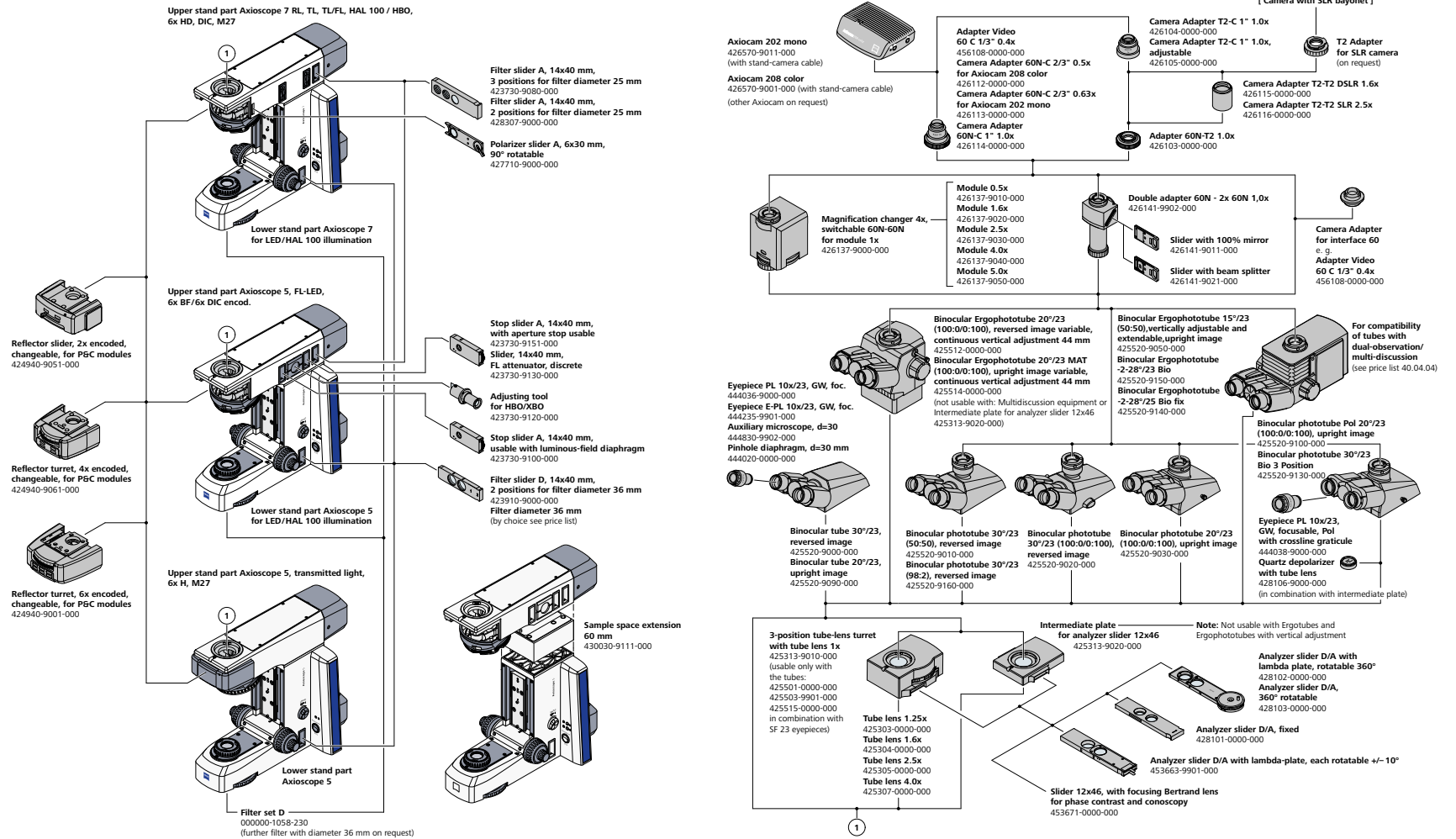

**Please note:** ZEISS AxioScope 7 is a non-IVD product, which may only be used for research.

# System Overview

- In Brief
- The Advantages
- The Applications
- The System
- Technology and Details
- Service

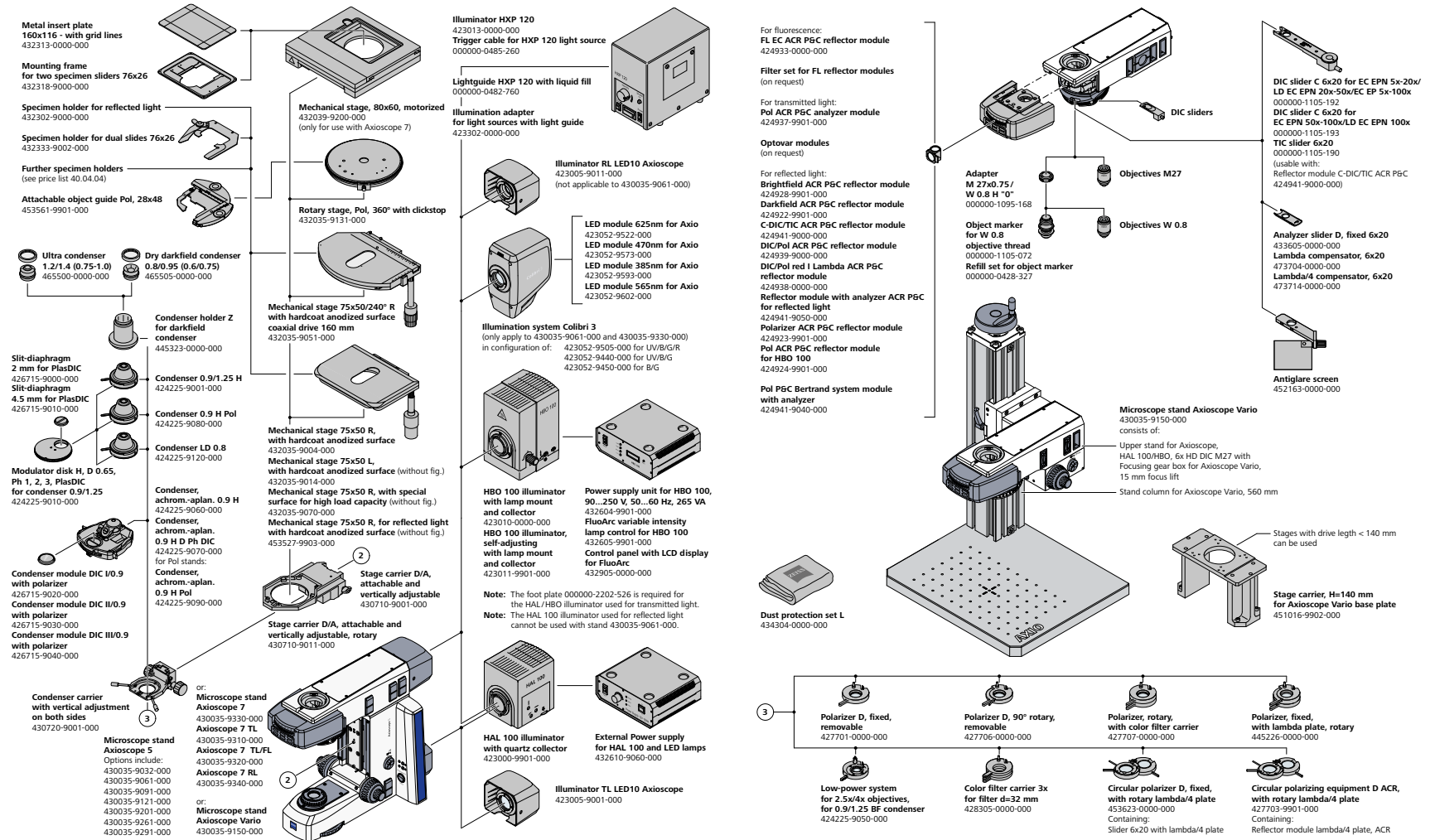

Please note: ZEISS Axioscope 7 is a non-IVD product, which may only be used for research.



# Technical Specifications

- › In Brief
- › The Advantages
- › The Applications
- › The System
- › **Technology and Details**
- › Service

	ZEISS Axioscope 5	Transmitted Light, HAL 50	Transmitted Light, LED/HAL 100	Transmitted Light and Fluorescence
<b>Transmitted light illumination</b>	Material Number	430035-9032-000	430035-9201-000	430035-9061-000
	TL light source	Hal 50W	LED 10W Optional Hal 100W	LED 10W Optional Hal 100W
	6-position TL filter wheel	●	●	●
<b>Fluorescence/ reflected light illumination</b>	FL/RL light source	NA	NA	Colibri 3 Optional HBO 100 and HXP 120 for FL or LED 10W/Hal 100W for non-fluorescence reflected light
	Status indicator of active FL-LED	NA	NA	● (for Colibri 3)
	Independent intensity control on stand of each FL-LED	NA	NA	● (for Colibri 3)
	FL-LED intensity memory function	NA	NA	● (for Colibri 3)
	Automatic mechanical shutter in TL for fluorescence imaging	NA	NA	●
	Reflector turret (or slider)	NA	NA	2, 4 or 6-position, encoded
	Mount for RL luminous-field diaphragm slider	NA	NA	●
	Mount for RL aperture stop slider or FL attenuator	NA	NA	●
	Mount for RL adjusting aid for HBO/XBO	NA	NA	●
Mount for RL filter slider R, 14x40 mm d=36 mm	NA	NA	●	

Tube specifications	Viewing angle	Adjustment	Viewing height* in mm
Binocular phototube 30° / 23 (50:50)	30°	–	449 / 485
Binocular phototube 30° / 23 (100:100)	30°	–	449 / 485
Binocular ergotube 15° / 23 (50 / 50), telescopic, height, upright image	15°	Height, telescopic	410 / 509
Binocular ergotube 20° / 23 (100 / 100), reversed image, 44 mm height	20°	Height	457 / 574
Binocular ergophototube –2° to 28° / 23 (50:50)	–2° to 28°	Inclination	356 / 507
Binocular ergophototube –2° to 28° / 25 (50:50)	–2° to 28°	Inclination	392 / 537

\* Range between the lower and upper setting of the eyepieces, e.g. 442 / 481 → 442 mm to 481 mm

# Technical Specifications

- › In Brief
- › The Advantages
- › The Applications
- › The System
- › **Technology and Details**
- › Service

	ZEISS Axioscope 5	Transmitted Light, HAL 50	Transmitted Light, LED/HAL 100	Transmitted Light and Fluorescence
<b>Observation and documentation</b>	Eco Mode	●	●	●
	Light Intensity Manager	●	●	●
	Snap button (to take images and videos) on stand	●	●	●
	RL/TL switch buttons	NA	NA	●
	Contrasting methods	BF, DF, Ph, simple TL Pol	BF, DF, Ph, simple TL Pol	BF, DF, Ph, PlasDIC, DIC, FL, TL/RL Pol
	Field of view	23 mm	23 mm	23 mm
	Optical system	Infinite, IC <sup>2</sup> S	Infinite, IC <sup>2</sup> S	Infinite, IC <sup>2</sup> S
	Camera tube	●	●	●
<b>Stand</b>	Full Köhler	●	●	●
	Nosepiece	6X H, encoded, M27	6X H, encoded, M27	6X H DIC, encoded, M27
	Stage	Mechanical stage 75×50 (rackless with hard coat anodized surface, right drive, extendable and with torque setting)	Mechanical stage 75×50 (rackless with hard coat anodized surface, right drive, extendable and with torque setting)	Mechanical stage 75×50 (rackless with hard coat anodized surface, right drive, extendable and with torque setting)
	Z Focus range	24 mm	24 mm	24 mm
	Focus	Coarse and fine focusing knobs on both left and right side; focus stop adjustment	Coarse and fine focusing knobs on both left and right side; focus stop adjustment	Coarse and fine focusing knobs on both left and right side; focus stop adjustment
	Specimen Holder	Dual slide holder for one-hand operation, spring lever left Optional: holder for single slide	Dual slide holder for one-hand operation, spring lever left Optional: holder for single slide	Dual slide holder for one-hand operation, spring lever left Optional: holder for single slide
	Ergotube	●	●	●
	Eyepiece, diopter adjustment	Up to ± 5 diopter	Up to ± 5 diopter	Up to ± 5 diopter
	Power Unit	Integrated	Integrated	Integrated



# ZEISS Service – Your Partner at All Times

Your microscope system from ZEISS is one of your most important tools. For over 175 years, the ZEISS brand and our experience have stood for reliable equipment with a long life in the field of microscopy. You can count on superior service and support - before and after installation. Our skilled ZEISS service team makes sure that your microscope is always ready for use.

- › In Brief
- › The Advantages
- › The Applications
- › The System
- › Technology and Details
- › **Service**

## Procurement

- Lab Planning & Construction Site Management
- Site Inspection & Environmental Analysis
- GMP-Qualification IQ/OQ
- Installation & Handover
- IT Integration Support
- Startup Training

## Operation

- Predictive Service Remote Monitoring
- Inspection & Preventive Maintenance
  - Software Maintenance Agreements
    - Operation & Application Training
    - Expert Phone & Remote Support
  - Protect Service Agreements
    - Metrological Calibration
    - Instrument Relocation
      - Consumables
      - Repairs

## New Investment

- Decommissioning
- Trade In

## Retrofit

- Customized Engineering
- Upgrades & Modernization
- Customized Workflows via ZEISS arivis Cloud



Please note: Availability of services depends on product line and location



**Carl Zeiss Microscopy GmbH**  
07745 Jena, Germany  
microscopy@zeiss.com  
[www.zeiss.com/axioscope](http://www.zeiss.com/axioscope)

**Follow us on social media:**

