

Enter the World of Reliable, High-End, Nano-Analysis.



ZEISS Sigma Family

Your Field Emission SEMs for High Quality Imaging and
Advanced Analytical Microscopy

zeiss.com/sigma



Seeing beyond

Your Field Emission SEMs for High Quality Imaging and Advanced Analytical Microscopy

- › In Brief
- › The Advantages
- › The Applications
- › The System
- › Technology and Details
- › Service

The ZEISS Sigma family combines field emission scanning electron microscope (FE-SEM) technology with an excellent user experience.

Structure your routines for imaging and analysis, and increase productivity with Sigma's intuitive workflow. You'll capture more data, faster than ever before. Make no compromises in high resolution imaging – go to low voltages and benefit from enhanced resolution and contrast at 1 kV or below. Choose from a variety of detector options to tailor Sigma precisely to your applications: you can study all kinds of samples no matter whether they are new materials under development, particles for quality inspection or biological or geological specimens. Take advantage of variable pressure (VP) imaging at the extremes to achieve excellent images and analytics on non-conductors with NanoVP lite, even at low voltages.

With the Sigma family you are entering the world of high-end nano-analysis. Sigma 360 is the core imaging facility's choice—an intuitive FE-SEM for imaging and analytics. Sigma 560 uses best-in-class EDS geometry to deliver high throughput analytics and enable automated *in situ* experiments.

Count on accurate, reproducible results – from any sample, every time.



Sigma 360. The Core Facility's Choice. Intuitive Acquisition.

- › In Brief
- › **The Advantages**
- › The Applications
- › The System
- › Technology and Details
- › Service

Be Guided Expertly from Setup to AI-Based Results: An Intuitive Imaging Workflow

When you're booked in for FE-SEM instrument time, you want the best possible results. You know that quality and speed usually come with experience, but – how long have you been operating an FE-SEM? What if it wouldn't matter? Get expert results with Sigma 360, even if you're a novice user. An easy-to-use workflow lets you streamline each step. Software automation in ZEISS SmartSEM Touch starts you off on the first steps of navigation, parameter setup and image acquisition. Then ZEN core comes into play. This is more than just a software interface: the ecosystem of ZEN core comes with task-specific toolkits. The AI Toolkit lets you segment images based on machine learning. Combine multi-modal experiments with the Connect Toolkit. Or use the Materials Apps to analyze microstructure.

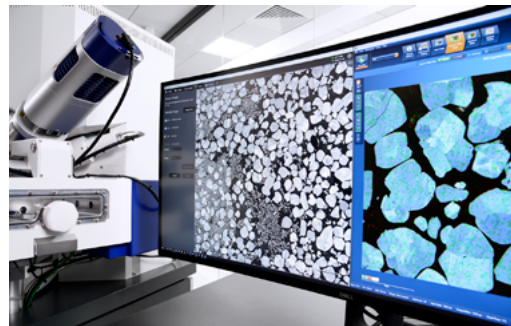

Large area, material contrast imaging of a metal sample (left side of monitor, acquired by SmartSEM Touch) simultaneous EDS mapping (right, via Aztec software, Oxford Instruments).

See the Difference at 1 kV and Below: Enhanced Resolution and Optimized Contrast

FE-SEMs are designed for high-resolution imaging. A reference specimen is easy to image, but what is vital is to get high-quality images from real-world samples—for example, charging aluminum oxide, or biological tissues prone to carbon contamination. The optical column is key to performance. Sigma operates with ZEISS Gemini 1 electron optics which provide excellent resolution on any sample, especially at low voltages. Uniquely, low-kV resolution for Sigma 360 is now specified at 500 V with 1.9 nm. An improvement in 1 kV resolution of more than 10%—at 1.3 nm—has been achieved by minimizing chromatic aberrations. Imaging is now easier than ever before, even on those challenging samples, even with backscatter detection in variable pressure mode.



A look inside the chamber with the annular BSE detector (aBSD) mounted under the pole piece of the objective lens enabling imaging in variable pressure (NanoVP lite mode) and 3D surface modelling (3DSM).

Perform VP Imaging at the Extremes: Excellent Performance on Non-Conductors

Studying non-conductive samples in an SEM takes either coating or variable pressure so that leaves you with two choices: lose information or live with reduced image quality. That's what a lot of SEM users assumed in the past, but suppose that's now wrong. Imagine you could work on battery cathode particles, or cultured cells under elevated pressures without coating or needing a skilled SEM user in your group. NanoVP lite and new detectors make it easy to achieve high-quality data from non-conductors below 5 kV. Imaging and EDS analytics are enhanced and deliver more surface-sensitive image information, faster acquisition times for images and maps—plus enhanced primary beam current for faster EDS mapping.

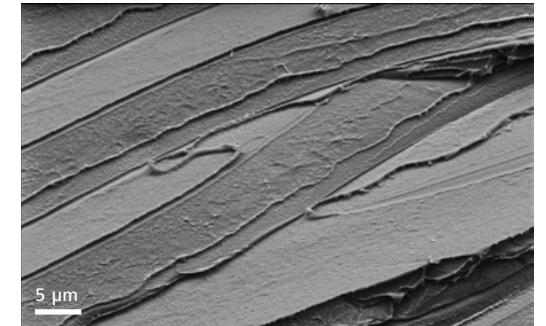

Speed up variable pressure imaging and gain more resolution and contrast, especially at low voltages. Fractured surface of polystyrene, C2D (Cascade Current) detector imaging in NanoVP lite mode.

Sigma 560. High Throughput Analytics. Automated *in situ* Experiments.

- › In Brief
- › **The Advantages**
- › The Applications
- › The System
- › Technology and Details
- › Service

Efficient Analytics of Real-World Samples: SEM-Based Analyses with Speed and Versatility

A mere understanding of a specimen's surface structure has long since ceased to be enough. The analysis of the chemistry of materials has made analytical accessories on an SEM a necessity. Sigma 560's best-in-class EDS geometry increases your analytical productivity. Get analytical data at half the probe current and twice the speed. The two 180° diametrically-opposed EDS ports guarantee throughput and shadow free mapping, even at low beam current and low acceleration voltage. Additional ports for EBSD and WDS on the chamber allow for analytics beyond EDS. Even non-conductors can be analyzed with the new NanoVP lite mode.



Gain information on topography and composition with Sigma 560 configured for throughput in analytics: two coplanar EDS detectors for information on chemical elements and an EBSD camera for crystallography.

Automate Your *in situ* Experiments: A Fully Integrated Lab for Unattended Testing

Ever worried about blocking the central lab's SEM for days to do *in situ* experiments—and then walking away with results that might not even be reproducible? Those days are behind you with the *in situ* lab for Sigma. This fully-integrated solution enables operator-independent results of heating and tensile tests in an unattended, automated workflow. Extend your workflow further by, for example, analyzing nano-scaled features in 3D: perform 3D STEM tomography by using Python scripting via the API functionality in SmartSEM or execute AI-based image segmentation with the ZEN AI Toolkit or APEER. The new aBSD4 permits live 3D surface modeling.

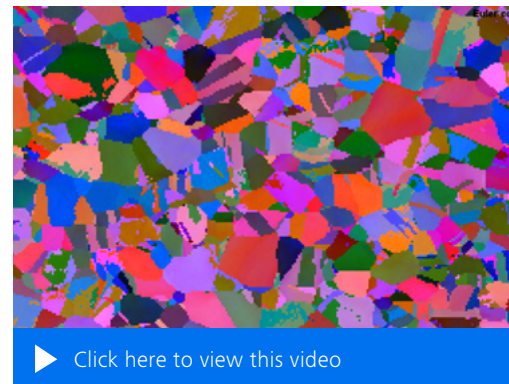

In situ heating and tensile experiment on steel. SEM imaging and EBSD analytics were performed simultaneously to investigate stress strain curves.

Image Challenging Samples Below 1 kV: Collect Comprehensive Sample Information

Now you can achieve best informative imaging and analysis at 1 kV or even 500 V: low-kV resolution for Sigma 560 is specified as 1.5 nm at 500 V. Challenging samples can easily be investigated under variable pressure in the new NanoVP lite mode, even with acceleration voltages as low as 3 kV, using either the new aBSD or C2D detector. If you are studying electronic devices, you will want to maintain a clean environment. You can protect your chamber from contamination more than ever, not only by the standard means of a (highly recommended) plasma cleaner, but also with the new large airlock that permits shuttling of 6" wafers.

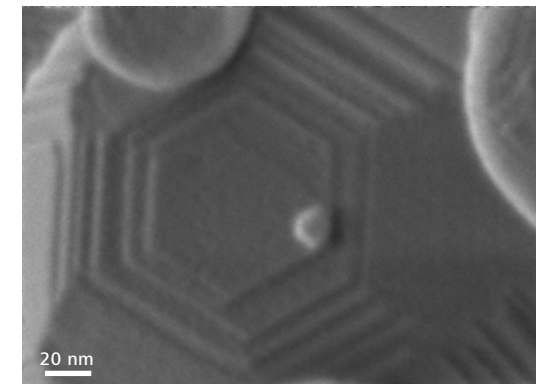

High resolution at 500 V: the measured size of this terrace of a sintered, nano-scaled sphere out of Al_2O_3 is 3 nm, InLens SE detector, Sigma 560.

Your Insight into the Technology Behind It

- › In Brief
- › **The Advantages**
- › The Applications
- › The System
- › Technology and Details
- › Service

Exploit the Gemini 1 Optical Design

ZEISS' Gemini 1 column, at the core of Sigma performance, is the technology behind its electron optical design taken to the next generation. That means you can count on complete and efficient detection, excellent resolution and superb ease-of-use.

The Gemini objective lens design combines electrostatic and magnetic fields to maximize optical performance while reducing field influences at the sample to a minimum. This enables excellent imaging, even on challenging samples such as magnetic materials. The Gemini detection concept ensures efficient signal detection by detecting secondary (SE) and/or backscattered (BSE) electrons.

These Inlens detectors are arranged on the optical axis, reducing the need for realignment and thus minimizing time-to-image. Gemini beam booster technology guarantees small probe sizes and high signal-to-noise ratios, right down to ultra-low accelerating voltages. It also minimizes system sensitivity to external stray fields by keeping the beam at high voltage throughout the column until its final deceleration. These advanced features—the Gemini design, Inlens detection and beam booster technology—are shared by both Sigma 360 and Sigma 560.

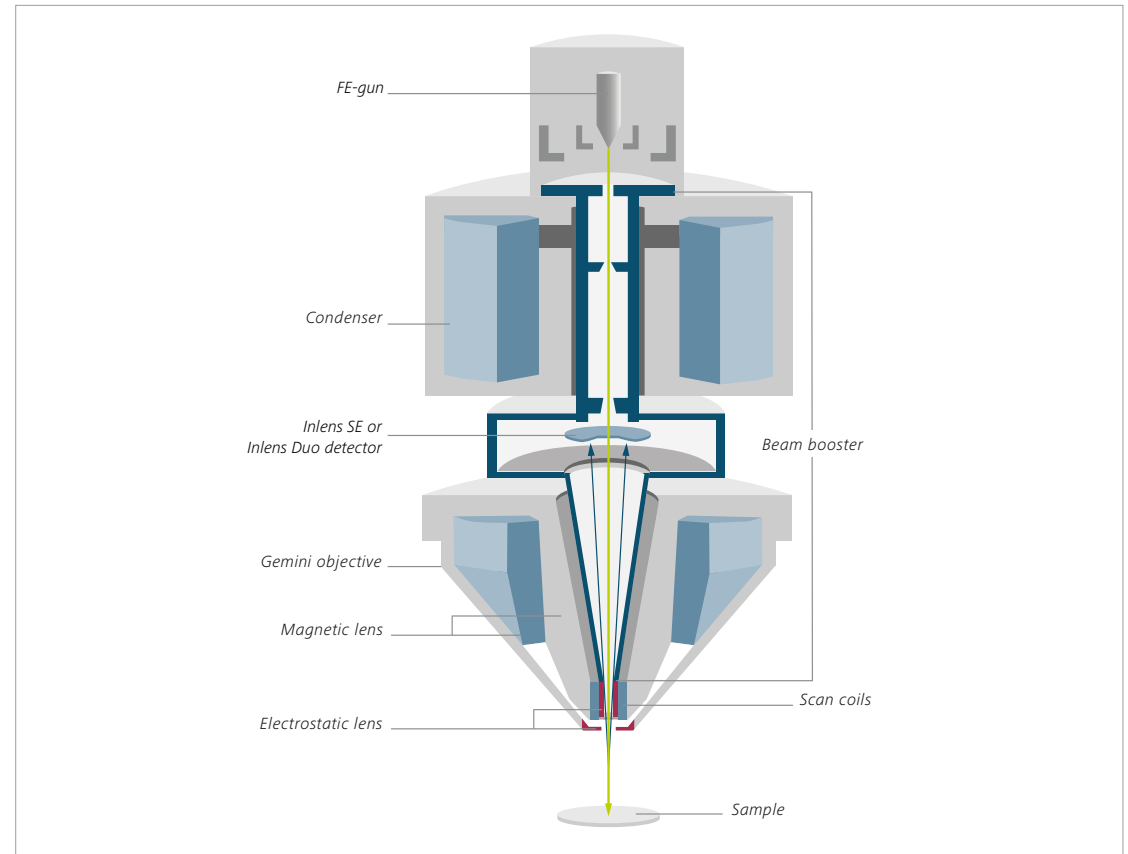

The Gemini 1 optical column comprises a beam booster, Inlens detector and a Gemini objective lens.

Your Insight into the Technology Behind It

- › In Brief
- › **The Advantages**
- › The Applications
- › The System
- › Technology and Details
- › Service

More Image Information at Low Voltage for Sensitive Samples

Today's SEM applications require high resolution imaging at low landing energy (known as low voltage or low kV) as standard because this is essential for investigating beam sensitive or non-conductive samples. It lets you derive true sample surface information without undesirable background signal from deeper sample layers. The electron gun and detection system of Gemini optics are optimized for resolutions at low and very low voltages, and for contrast enhancement. In scanning electron microscopy, a low kV primary energy beam is used for imaging beam sensitive samples because less energy is transferred to the sample. At the same time, the low energy beam is not penetrating the sample as much. This way you can image artifact free surface details on sensitive samples with high resolution.

Optimization of Low kV Imaging

Electron optical aberrations lead to a loss in resolution and are more often present in low voltage images. By design, the beam booster technology of the Gemini 1 column already provides an excellent low kV resolution. Optimized apertures and the high resolution gun mode now enable further low kV imaging enhancements.

High Resolution Gun Mode

In high resolution gun mode, the reduced energy spread of the primary beam minimizes the effect of chromatic aberration to allow even smaller probe sizes. At voltages of 1 kV and below this mode provides additional resolution. The condenser is set for best imaging conditions with optimized beam convergence by default. You can choose optimized apertures that provide a range of currents and ensure high resolution at the same time. Additional condenser settings are available for optimized image depth.

Detection

In general, the use of low primary electron beam voltage and low beam probe currents enables high-resolution imaging for sensitive materials. When it comes to detecting the electrons excited from the sample, the highly efficient InLens SE detector delivers not only high resolution but also enhanced contrast at probe currents below 10 pA. Supported by intelligent scan routines such as Drift Corrected Frame Averaging, gentle treatment of the sample is guaranteed, even at high resolution.

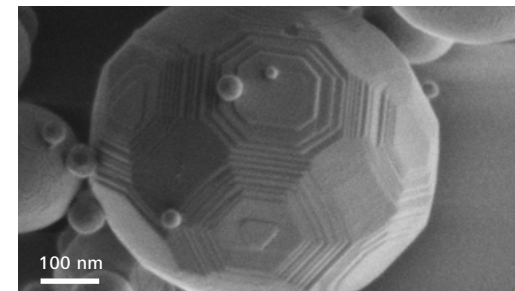

High resolution at 500 V: Al_2O_3 spheres with 3 nm spaced terraces of sintered particles.

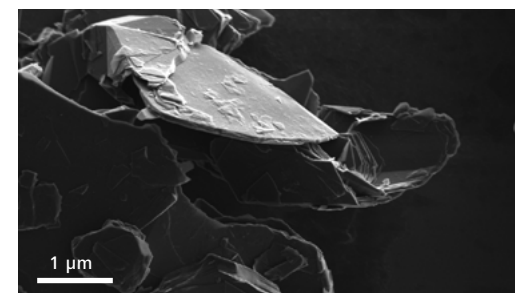

High resolution at 1 kV: Surface sensitive imaging conditions allow the imaging of delicate graphite material used for battery anodes.

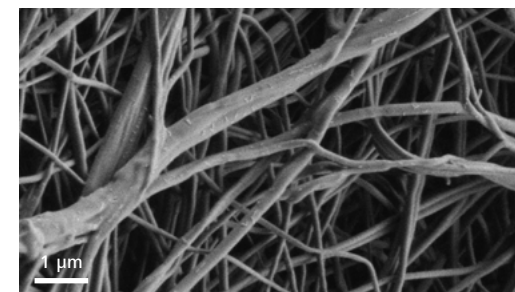

Biomaterial at 500 V: Beam sensitive materials like gelatin fibers can be imaged artifact-free under very low beam energy and with gentle scanning routines. Sample courtesy of Fraunhofer Institute for Microstructure of Materials and Systems IMWS, Halle, Germany.

Your Insight into the Technology Behind It

- › In Brief
- › **The Advantages**
- › The Applications
- › The System
- › Technology and Details
- › Service

Use Flexible Detection for Clear Images

Characterize all of your samples with the latest detector technology.

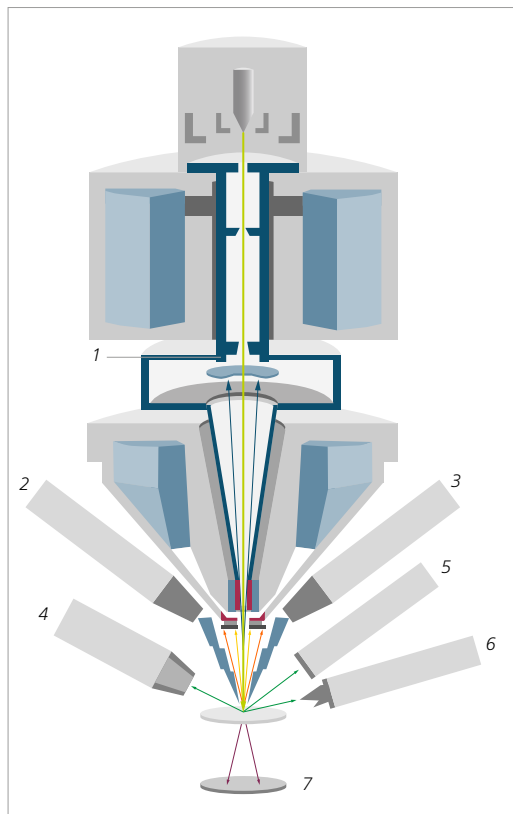

Schematic cross-section of Gemini 1 optical column with detectors.

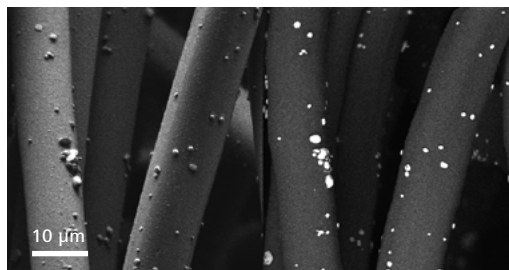

1 Inlens Detectors

Inlens SE: A high resolution in-column SE detector. Inlens Duo: Inlens SE and BSE detector for sequential high resolution topographical and compositional imaging. (*only available for Sigma 560)*

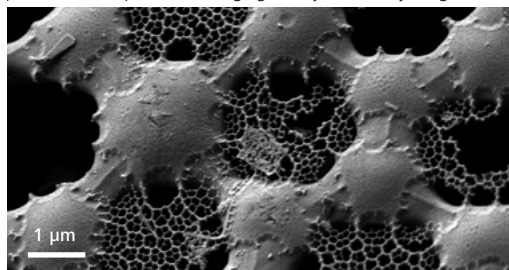

4 ETSE Detector

Everhart-Thornley Secondary Electron (ETSE) Detector for high resolution topographic imaging with increased signal-to-noise and reduced charging at low kV in high vacuum mode.

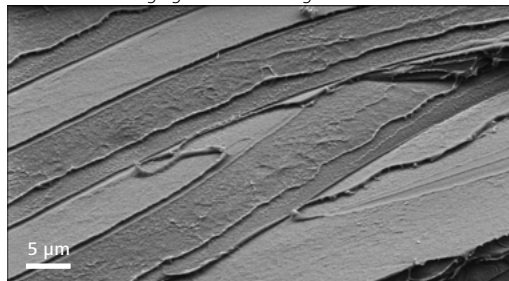

6 C2D G2

Second generation Cascade Current Detector that creates an ionization cascade and measures the resulting current. This provides crisp images in VP mode, even at higher pressures and lower voltages.



2 / 3 Advanced EDS Detection

Advanced EDS analysis geometry of 8.5 mm working distance and 35° take-off angle for delivering data at twice the speed or half the probe current. Sample: courtesy of University of Leicester.



5 VPSE G4

4th generation Variable Pressure SE detector provides improved imaging performance in VP mode with up to 85% more contrast.

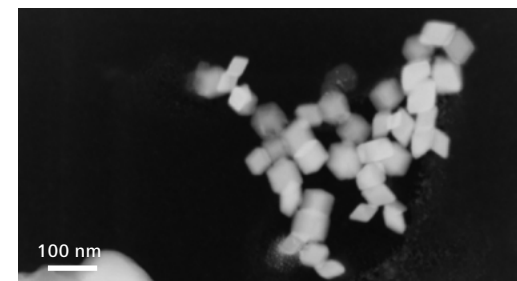

7 aSTEM

Annular STEM detector for producing high resolution transmission images. Provides brightfield, darkfield and high angular darkfield (HAADF) modes, e.g. of thin films or biological sections.

Your Insight into the Technology Behind It

- › In Brief
- › **The Advantages**
- › The Applications
- › The System
- › Technology and Details
- › Service

Use Flexible Detection for Clear Images
 Characterize all of your samples with the latest BSE detector technology.

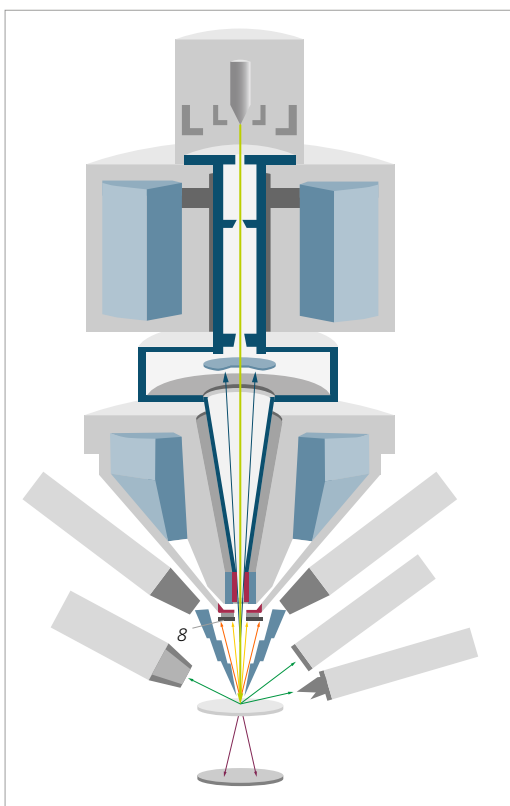

Schematic cross-section of Gemini 1 optical column with detectors.

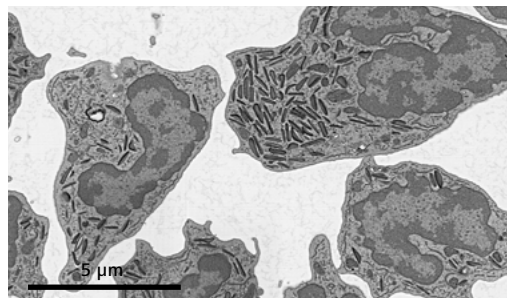

8 Sense BSD

Solid state detector for low kV BSE detection & high speed optimized for beam-sensitive samples like ultra-thin sections.

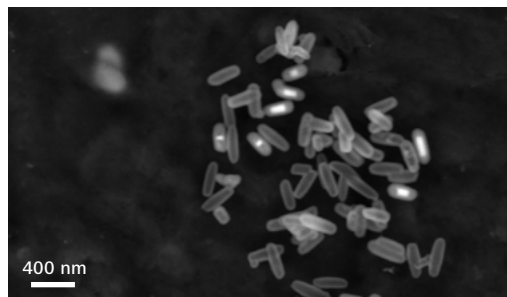

8 HDBSD

High definition BSE detector for excellent low kV compositional imaging of all samples in all vacuum modes.

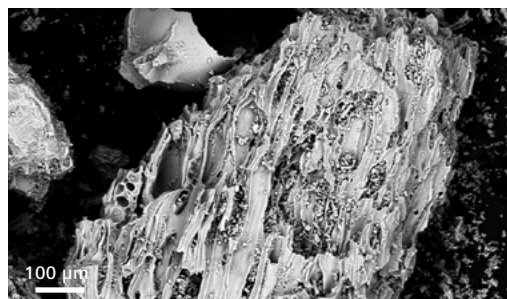

8 YAG BSD

YAG crystal based scintillator BSE detector provides fast, easy compositional imaging.

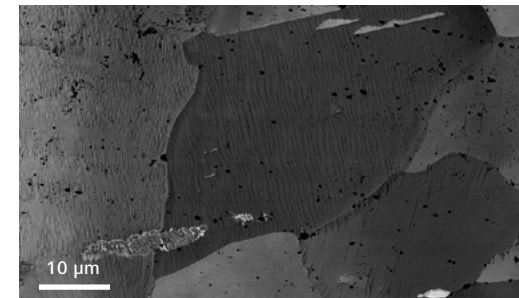

8 AsB Detector

Angular selective BSE detector for crystallographic and channeling contrast imaging of metals and minerals.

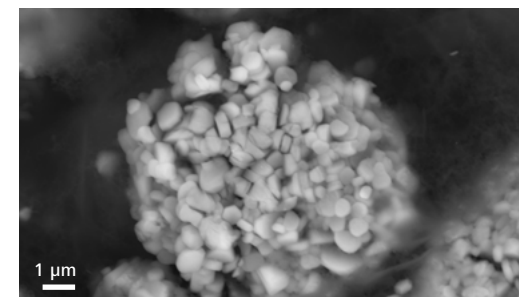

8 aBSD1

Annular BSE detector for excellent low kV compositional imaging, crystalline surface analysis, and 3D surface modeling under all vacuum conditions.

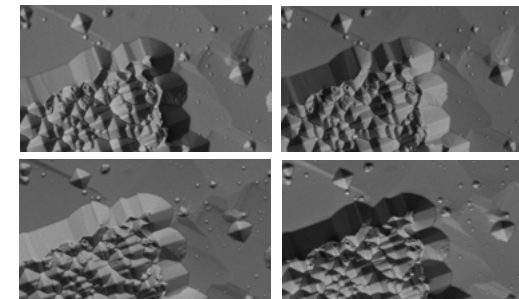

8 aBSD4

Annular BSE detector with up to 4 parallel channels for compositional and topographical contrast imaging at low voltage and live, real-time 3D surface modeling.

Your Insight into the Technology Behind It

- › In Brief
- › **The Advantages**
- › The Applications
- › The System
- › Technology and Details
- › Service

Variable Pressure Imaging

Variable pressure in the SEM chamber lets you investigate insulating, non-conducting or outgassing materials without modifying the surface with a conductive coating. The collision of the primary electron beam with gas molecules produces ions which compensate charging of the sample. This creates a “skirt” around the beam.

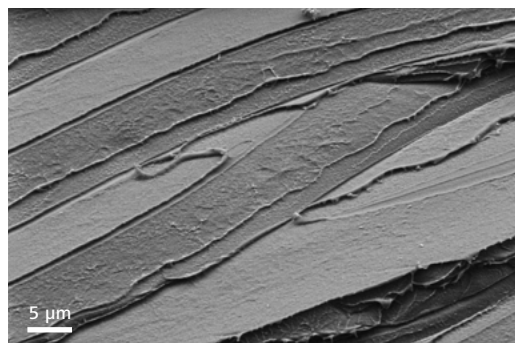

Imaging in NanoVP lite mode at 60 Pa chamber pressure. The surface of a polystyrene sample was fractured to understand crack formation and adhesion at interfaces in polymers.

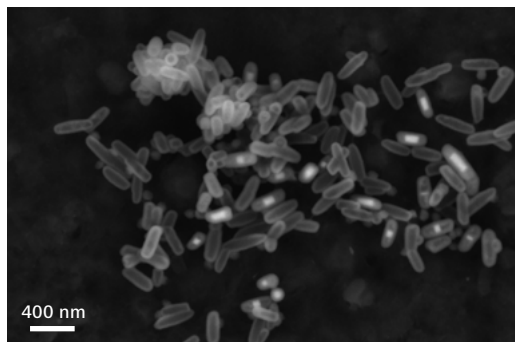

Backscatter imaging in NanoVP lite mode with the aBSD detector reveals iron oxide in silica-nanocapsules. Sample: courtesy of Dr. V. Brune, Institute of Inorganic Chemistry, University of Cologne, Germany.

NanoVP lite Mode for Analytics and Imaging

The NanoVP lite mode drastically reduces the skirt effect and the beam gas path length. As a result, you can achieve faster analytics and more precise measurements.

Moreover, the reduced skirt means that both SE and BSE imaging will produce images with an enhanced signal-to-noise ratio and thus better image quality, especially at low kV.

The retractable annular backscatter detector (aBSD) delivers excellent material contrast: it carries the beam sleeve with its integrated pressure-limiting aperture and is fitted under the pole piece during NanoVP lite operation. The aBSD with its five annular segments provides high throughput and low voltage compositional and topographical contrast imaging. It is suitable for VP and HV (high vacuum), matching real-world sample requirements while remaining easy to operate.

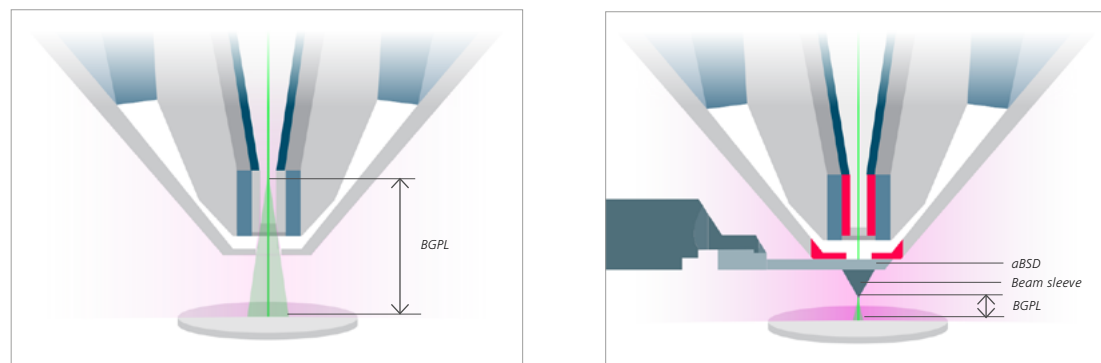

Comparison of Standard VP and NanoVP lite modes: Left, gas distribution (pink) and electron beam skirting (green) in VP mode and, right, in NanoVP lite mode. Thanks to the beam sleeve containing a pressure-limiting aperture and being fitted under the aBSD detector, the electron beam travels only a very short distance in the low vacuum (beam gas path length BGPL), thus reducing the skirt effect and enhancing the quality of images and analytic results.

Your Insight into the Technology Behind It

- › In Brief
- › **The Advantages**
- › The Applications
- › The System
- › Technology and Details
- › Service

Automate and Speed Up Your Workflow

Get expert results easily and control all the functionality of the Sigma family from setup to post-processing with a streamlined, automated workflow. This gives you the benefit of fast time-to-image and saves time on training, too – especially in a multi-user environment. Work with SmartSEM Touch for the initial steps. Then use the ecosystem of the ZEN core software for more sophisticated post-processing such as AI-based analyses or reporting in quality control.

Navigate your sample quickly and easily with colored “real-world”, digital camera images.

One click sets the optimal imaging conditions for your sample, opening up access to even novice users.

Optimize image acquisition or identify regions of interest (ROIs) – and let the images be created automatically.

Correlate data, segment images or classify objects, then measure and report your results.

1. Image Navigation

2. Sample Type Selection

3. Automation

4. Post-processing

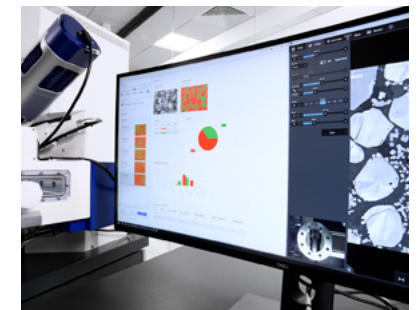
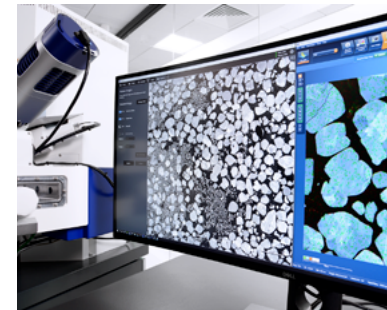
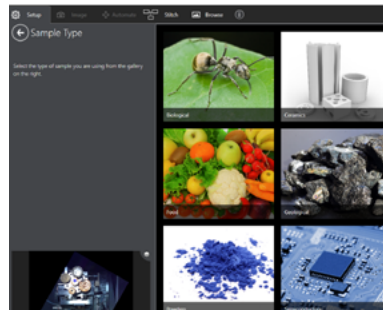
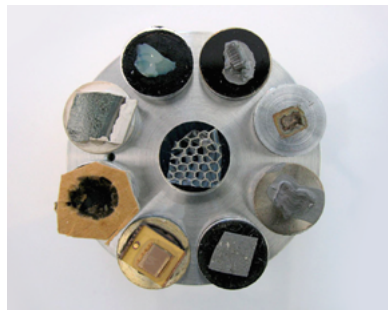

Your Insight into the Technology Behind It

- › In Brief
- › **The Advantages**
- › The Applications
- › The System
- › Technology and Details
- › Service

Raman Spectroscopic Imaging – Getting a Chemical Fingerprint

Combine your Sigma with Raman imaging. Profit from the correlation of a research-grade Confocal Raman imaging (CRI) microscope with a ZEISS FE-SEM tailored for high quality imaging. Experience fully integrated Raman Imaging and Scanning Electron Microscopy (RISE).

The Raman Spectroscopy Principle

Raman spectroscopy allows for the detection, identification and quantification of solid state materials through their unique vibrational and rotational energy level structure. Each Raman spectrum is unique for a given chemical composition and provides qualitative and quantitative information of the material: a chemical fingerprint.

RISE Microscopy – How it works

For RISE microscopy the region of interest of the sample is automatically transferred from one objective to the other. The sample stays within the vacuum chamber of the SEM during the entire measurement. That results in a streamlined workflow drastically improving ease of use. In a typical workflow the sample will be imaged with the SEM first, afterwards the stage will be moved automatically to the position of the Raman objective for subsequent Raman imaging.

In addition to material identification, Raman spectroscopy can also be used to measure strain and stress, crystal polymorphs and orientation, doping and crystallinity. Thus it delivers complementary information to other analytical methods commonly used in an SEM, such as EDS.

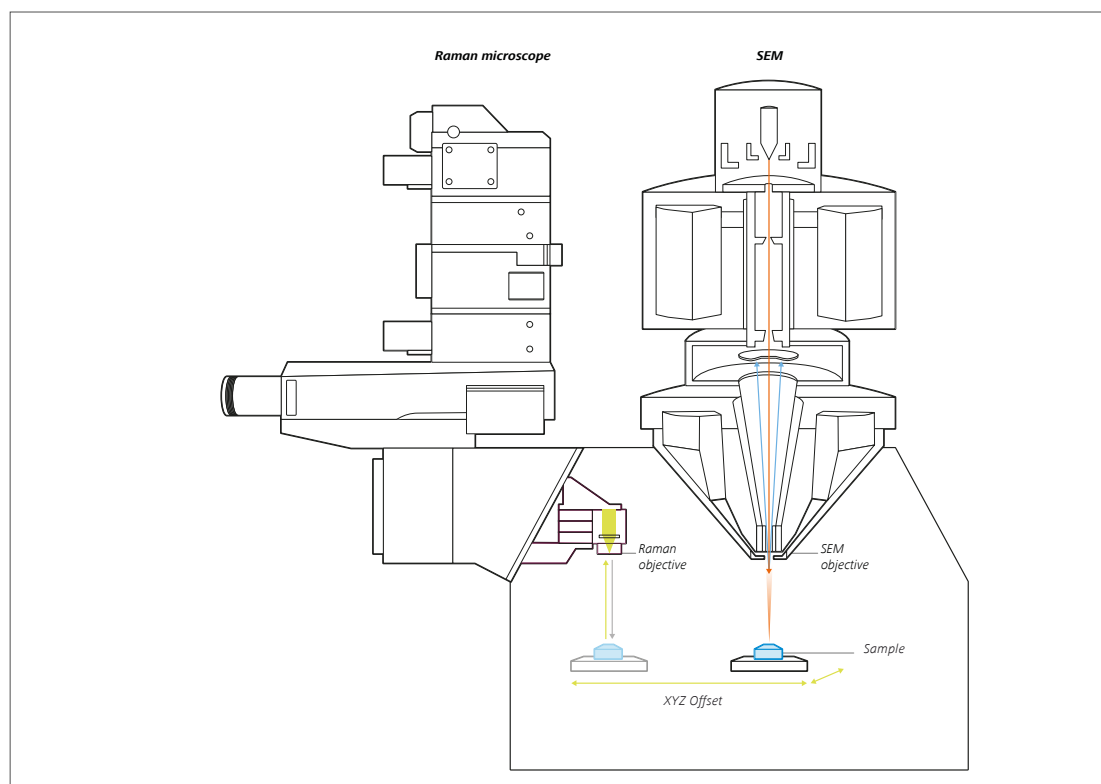

Principle of RISE Microscopy: The Raman microscope is attached to the chamber of the SEM. The sample is investigated with both microscopic techniques under vacuum in the SEM chamber. An integrated software module facilitates the workflow. (Raman beam green, SEM beam orange).

ZEISS Sigma at Work: Materials Science

- › In Brief
- › The Advantages
- › **The Applications**
- › The System
- › Technology and Details
- › Service

As a materials researcher you are always striving to develop novel materials, that is why you need to understand and control structures at the micro- and the nanoscale if you are to advance existing technology. Better and cheaper electronic devices might well come with such continuous progress, offering more processing power, catalysts to promote the efficient use of energy and resources, and a whole range of improvements in medicine, diagnostics, disease treatment and patient care. A ZEISS FE-SEM like Sigma is your indispensable tool for leveraging this vital understanding at the nanometer scale.

Typical Tasks and Applications

- Use a variety of detectors to perform high resolution imaging and analysis for characterizing your sample comprehensively. Investigate topography with SE detectors and study composition, crystallography and elemental distribution by choosing from several BSE detectors.
- Use the aSTEM detector to analyze, for example, thin films to provide you with high resolution transmission images.
- Characterize 2D materials by combining high resolution SEM imaging and EDS elemental analysis with Raman spectroscopy imaging. Study defects, dislocations and strain.
- Differentiate various types of polymers with correlative microscopy using SEM and Raman. Analyze stress in fibers and laminate films. Determine crystallinity levels.
- Understand aging effects and improve the quality of devices in battery research. Combine high resolution SEM imaging, EDS elemental analysis and Raman spectroscopic imaging. Keep air-sensitive samples in the SEM chamber under vacuum at all times.

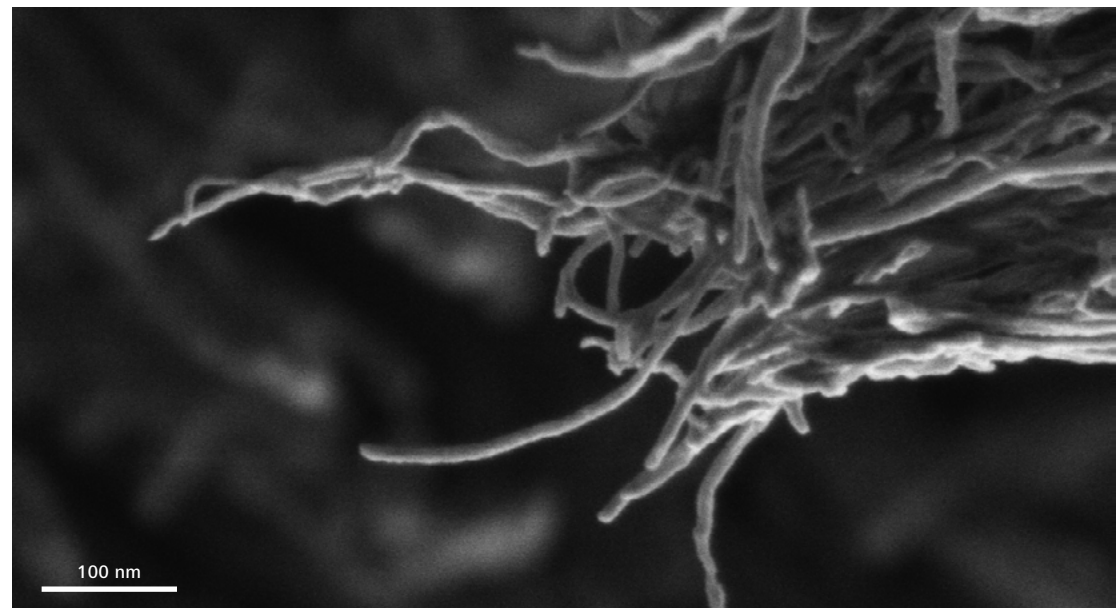

As carbon nanotubes (CNT) are extremely delicate structures, they are the prime example of susceptibility to beam damage. Low voltage imaging is therefore the best possible approach to visualizing their details in the highest possible resolution with the fewest possible artifacts. Image acquired at 500 V acceleration voltage, Inlens SE detector, Sigma 560.

ZEISS Sigma at Work: Materials Science

- › In Brief
- › The Advantages
- › **The Applications**
- › The System
- › Technology and Details
- › Service

Nanoscience & Nanomaterials

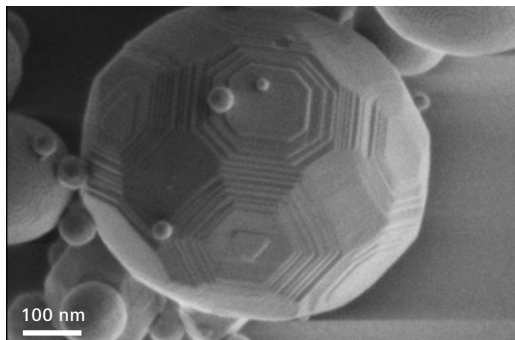

Al_2O_3 spheres. Terraces of sintered particles are visible under surface-sensitive imaging with high resolution at 500 V. Some distances between terraces are as small as 3 nm.

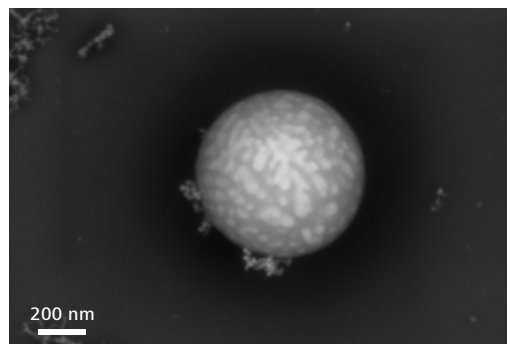

Cerium and iron containing flintstone from a firelighter. Material contrast is easy to visualize with the Sense BSD detector at low voltage, here at 2 kV.

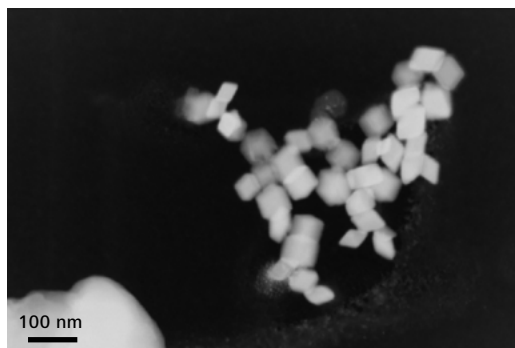

25 – 50 nm iron oxide particles imaged with the aSTEM detector in darkfield mode at 20 kV.

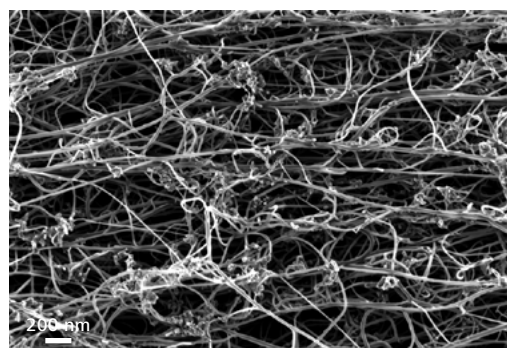

Carbon nanofibers can be imaged easily and without damage to their delicate structure using the Inlens SE detector at 1 kV in high vacuum.

Raman Imaging (2D Materials & Polymers)

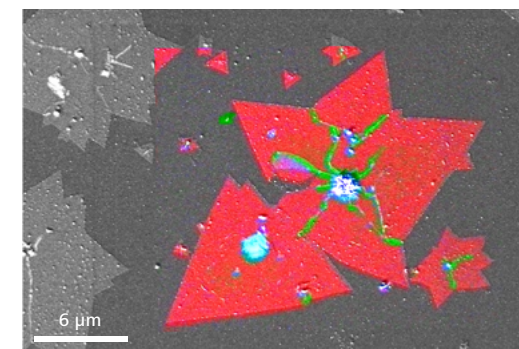

CVD-grown MoS_2 2D crystals on Si/SiO_2 substrate: The RISE image demonstrates wrinkles and overlapping parts of the MoS_2 crystals (green), multilayers (blue) and single layers (red).

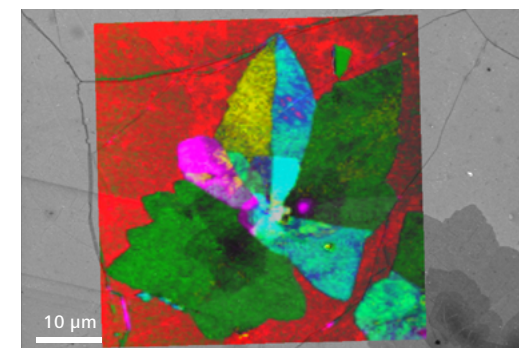

CVD-grown graphene layers: The red areas of the RISE image show a monolayer of graphene. The twist angles between the overlapped graphene films are determined by using Raman spectroscopic imaging. The twist angle $>20^\circ$ is blue, twist angle $3-8^\circ$ is green and twist angle 12° is purple.

ZEISS Sigma at Work: Materials Science

- › In Brief
- › The Advantages
- › **The Applications**
- › The System
- › Technology and Details
- › Service

Energy Materials

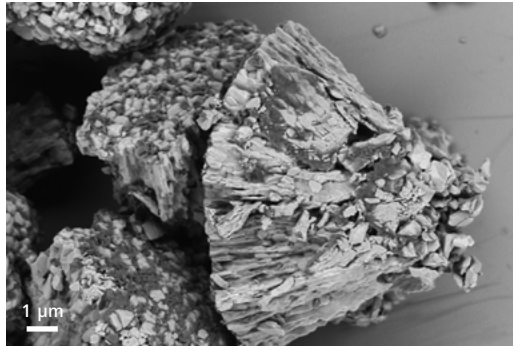

The surface of a particle from a cathode foil of a battery. Material contrast is used to identify the binder (darker material) on the Li-NMC (Lithium Nickel Manganese Cobalt oxide batteries), imaged with the aBSD.

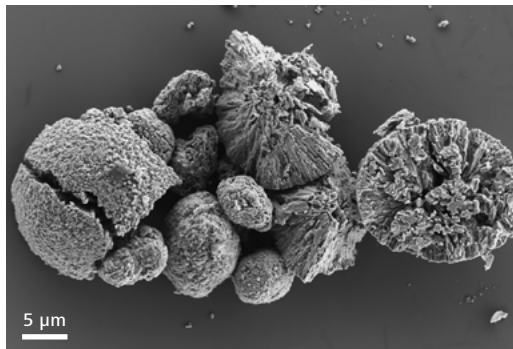

Battery cathode. The same fractured Li-NMC particles from the picture at the top, imaged with the chamber SE detector for topographical contrast.

Engineering Materials: Metals and Alloys

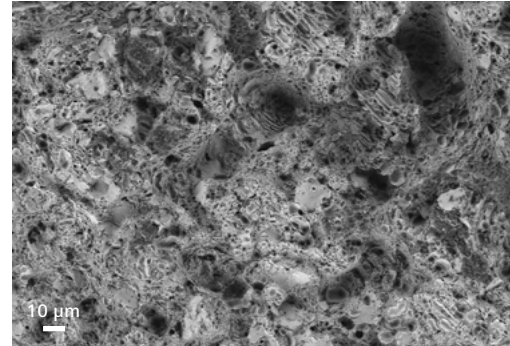

The aBSD image reveals fractured metal surface morphology and delivers compositional information, even at a long working distance.

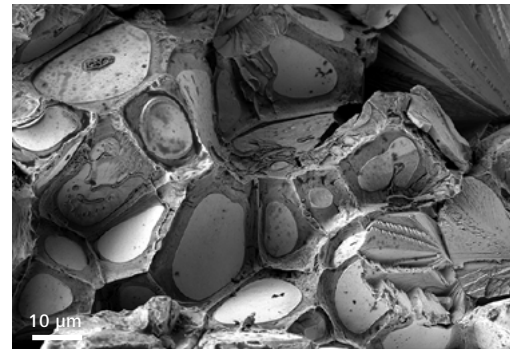

Advanced alloy material imaged at 3 kV in high vacuum shows the tungsten core material surrounded by a steel matrix.

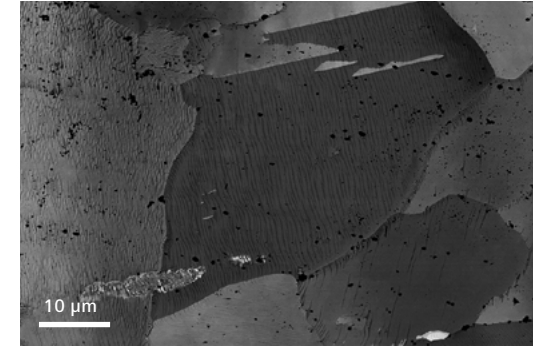

Platinum grains showing grain boundary slip planes, imaged at 4 kV with AsB detector.

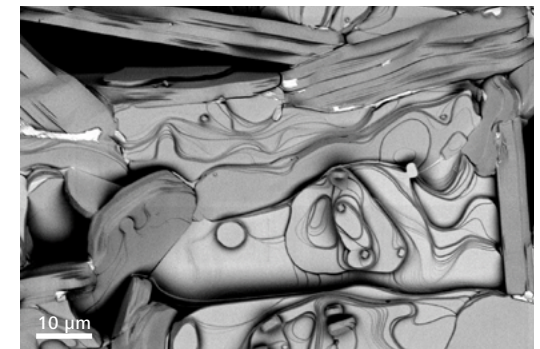

Super alloy sample imaged at 1 kV with the aBSD.

ZEISS Sigma at Work: Materials Science

- › In Brief
- › The Advantages
- › **The Applications**
- › The System
- › Technology and Details
- › Service

Pharmaceutical Research

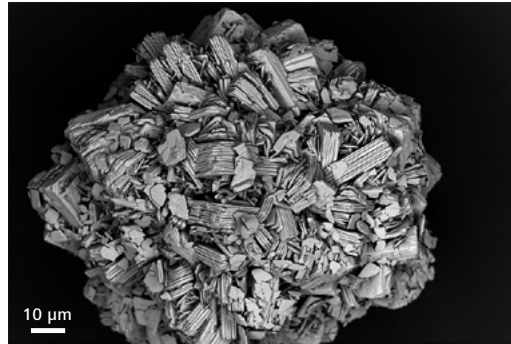

Lanthanum carbonate imaged at 1 kV with Inlens Duo BSE. LaCO_3 is a phosphate binder used as an oral therapeutic agent for dialysis patients.



Aluminum chlorohydrate from an aerosol antiperspirant obtained at 7 kV and 25 Pa chamber pressure with VPSE.

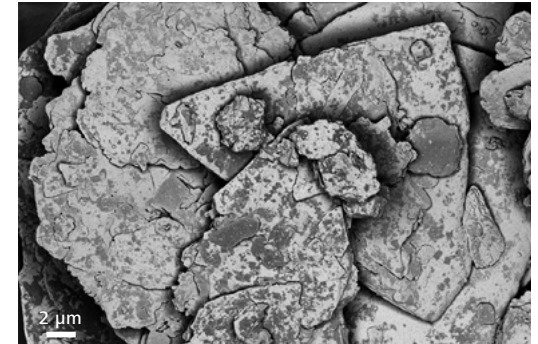

The Inlens Duo in BSE mode at 1 kV reveals the structure and compositional information of delicate lamellae of sericite mica and kaolin clays used as cosmetic fillers.

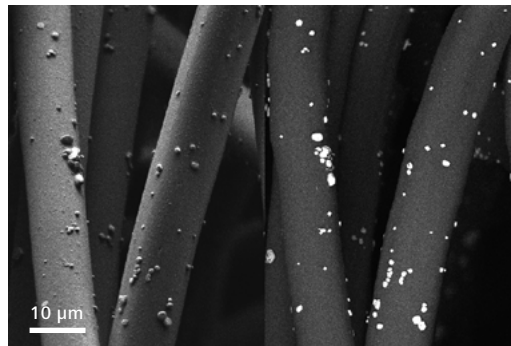

Fibres with embedded silver nanoparticles, 1 kV, left: Inlens Duo SE, right: Inlens Duo BSE. Originate from antimicrobial dressings in wound care.

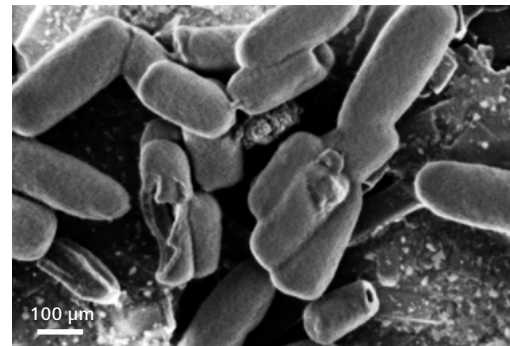

MSC capsules (hollow mesoporous silica) for drug delivery. Inlens SE detector at 500 V. Sample: courtesy of V. Brune and S. Mathur, Institute of Inorganic Chemistry, University of Cologne, Germany.

ZEISS Sigma at Work: Materials Science

- › In Brief
- › The Advantages
- › **The Applications**
- › The System
- › Technology and Details
- › Service

Catalysts & Chemicals

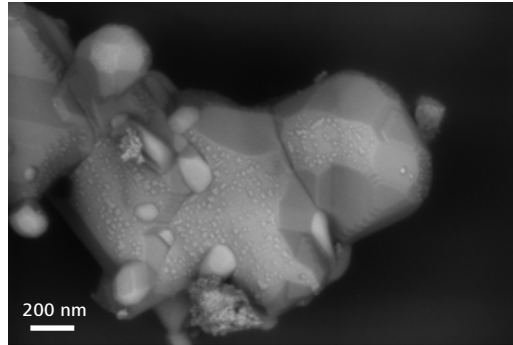

Catalytic particles, lanthanum calcium titanate, decorated with platinum particles, imaged with Sense BSD at low voltage, here 1 kV.

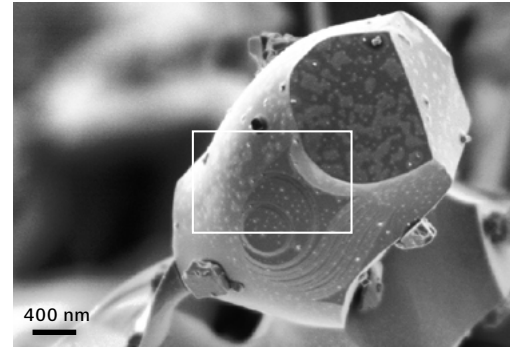

Perovskite. Distribution of platinum decoration on reduced areas under sweet spot imaging conditions: 5 kV, working distance 3.5 mm.

Polymers

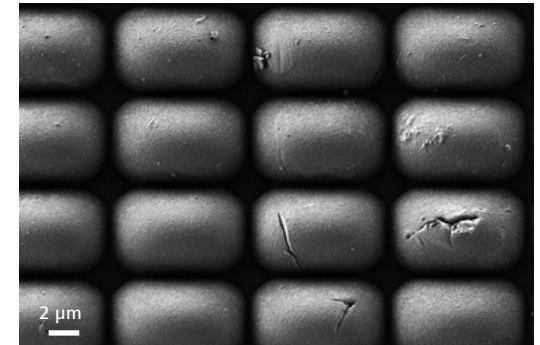

Even at 300 V, the ETSE reveals high surface detail in surface defect inspection of non-conductive microlenses.

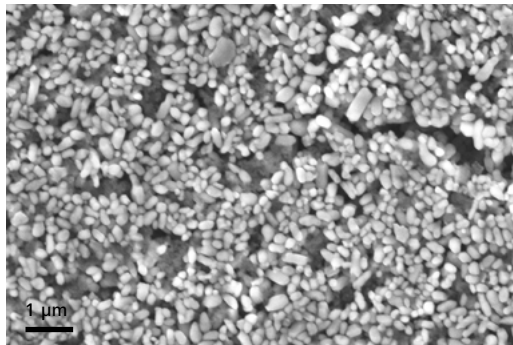

Non-conductive titanium dioxide nanoparticles used as pigments and opacifying agents can be imaged easily at 40 Pa in VP mode with the C2D.

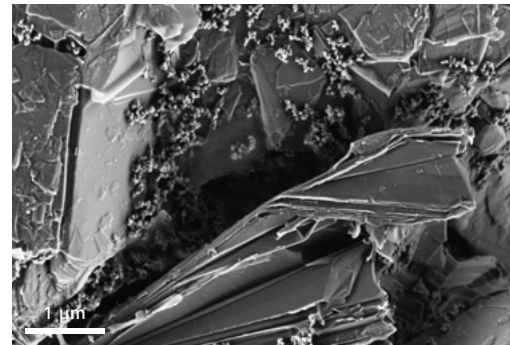

Graphite flakes investigated with low kV surface-sensitive imaging, acquired on Sigma with the chamber SE2 detector at 1 kV.

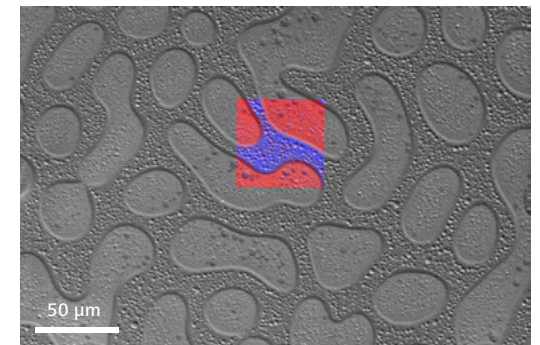

Polymer mixture of polystyrene (PS) and polymethyl methacrylate (PMMA): These two polymers form an immiscible blend. The domain structures are clearly imaged where PS is blue and PMMA is red.

ZEISS Sigma at Work: Life Sciences

- › In Brief
- › The Advantages
- › **The Applications**
- › The System
- › Technology and Details
- › Service

In all life sciences— from zoology and plant sciences to developmental biology, neuroscience research and cell biology—scanning electron microscopy is essential for exploring the ultrastructural details of biological samples.

SEMs allow 3D imaging with a resolution that reveals even cell-cell contacts. By combining complementary microscopy technologies or contrasting techniques, you can get a holistic view of your samples and find answers to your scientific questions.

Typical Tasks and Applications

- Characterize topology of beam-sensitive and delicate biological specimens such as spores, diatoms or fixed tissue in high resolution with the ETSE, Inlens SE or C2D detector.
- Acquire images of sensitive, non-conductive, outgassing or low-contrast samples easily by studying non-conductive samples without coating in VP mode or by using low voltage approaches.
- Combine VP or low-voltage applications with confocal Raman imaging to study the chemical fingerprint of biomaterials.
- Visualize the ultrastructure of cells, tissues etc. at high resolution with Inlens detection or choose from a suite of backscatter detectors.
- Image large areas such as serial sections or block-faces to acquire 3D ultrastructural information about large sample volumes.

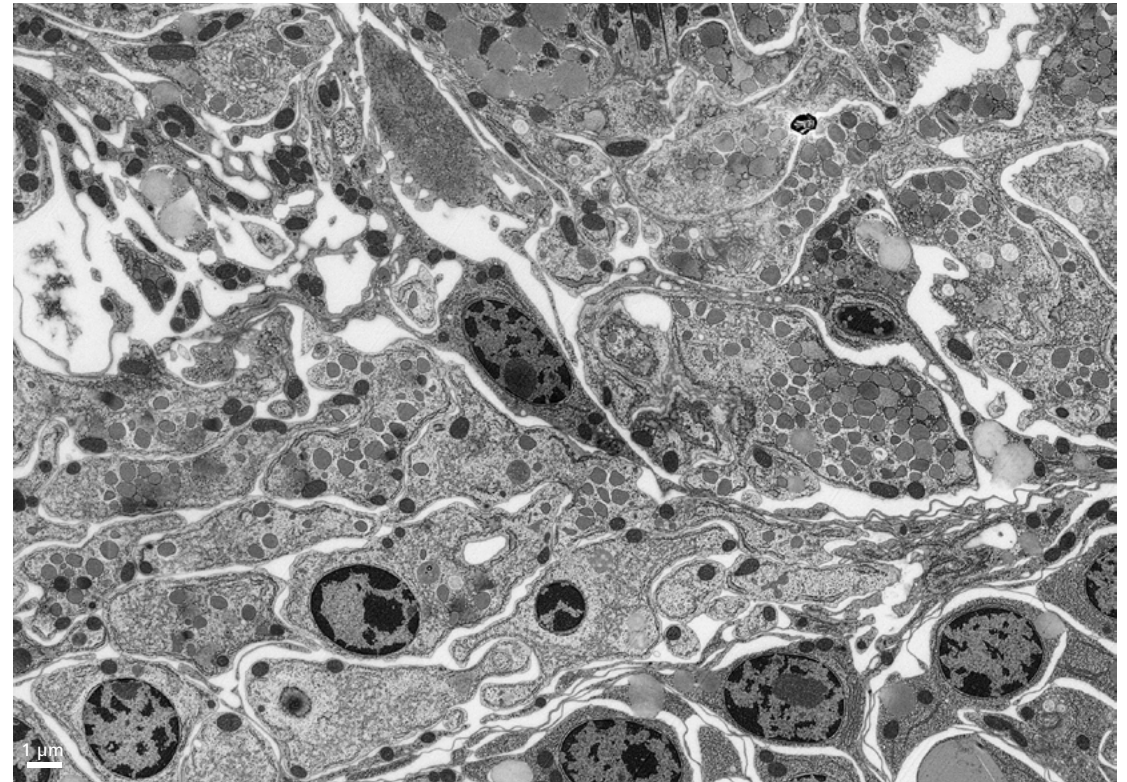

Ultrastructure of the bryozoan *Tricellaria inopinata*, a sessile marine species, field of view 30 μm . Sample: courtesy of Anna Seybold and Harald Hausen, Sars Centre for Marine Molecular Biology, University of Bergen, Norway. Acquired with ZEISS Sigma 560, Sense BSD detector, 1 kV, 30 pA.

ZEISS Sigma at Work: Life Sciences

- › In Brief
- › The Advantages
- › **The Applications**
- › The System
- › Technology and Details
- › Service

Topology

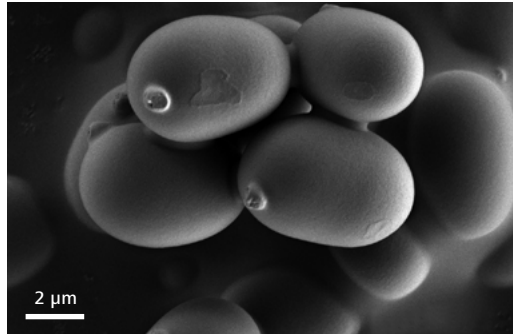

Mushroom spores imaged at 1 kV at high vacuum. These delicate, fragile structures can be imaged easily with Sigma 560 at low voltage.

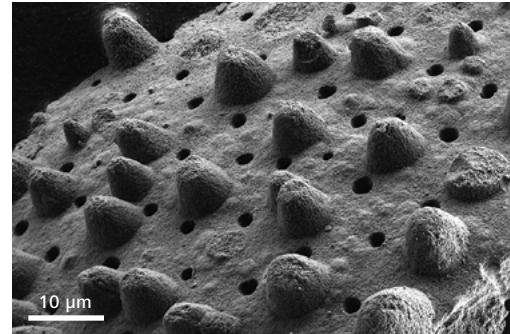

The ETSE detector used at 3 kV in high vacuum clearly reveals surface detail and pores in the calcite wall of the planktonic foraminifera wall.

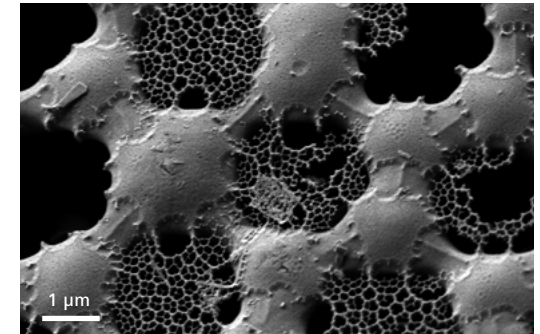

The delicate open structure of a non-conductive diatom can be imaged with the ETSE at low kV in high vacuum without charging artifacts.

Ultrastructure

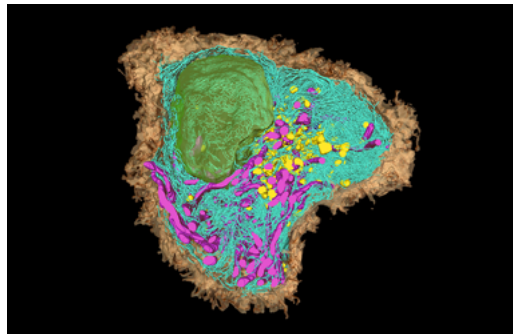

High-resolution ultrastructure of a dendritic cell, showing intracellular organs segmented from serial block-face imaging data. Sample: courtesy of Dr. Peter Munro and Hannah Armer, UCL Institute of Ophthalmology, UK.

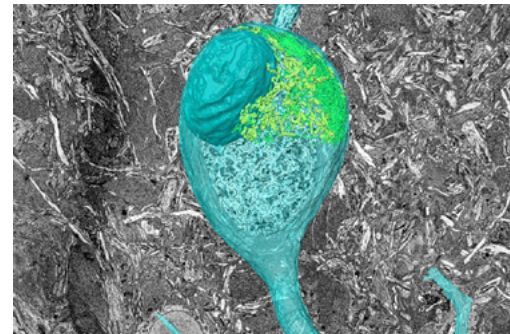

Automatic acquisition of 3D brain ultrastructure using serial block-face imaging. Astrocyte (cyan) was identified and segmented. Sample: courtesy of Dr. Peter Munro and Hannah Armer, UCL Institute of Ophthalmology, UK.

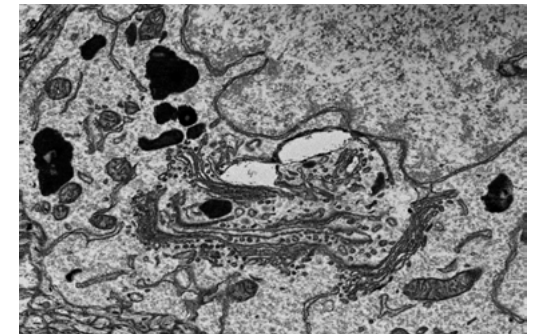

Mouse cortex revealing ultrastructural details, imaged with BSD.

ZEISS Sigma at Work: Life Sciences

- › In Brief
- › The Advantages
- › **The Applications**
- › The System
- › Technology and Details
- › Service

Raman Imaging of Biomaterials

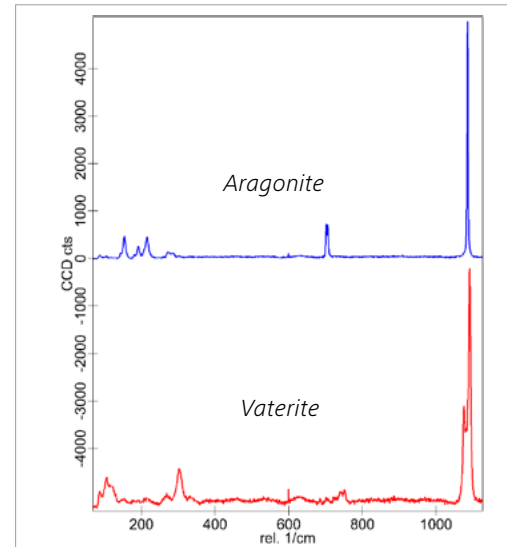
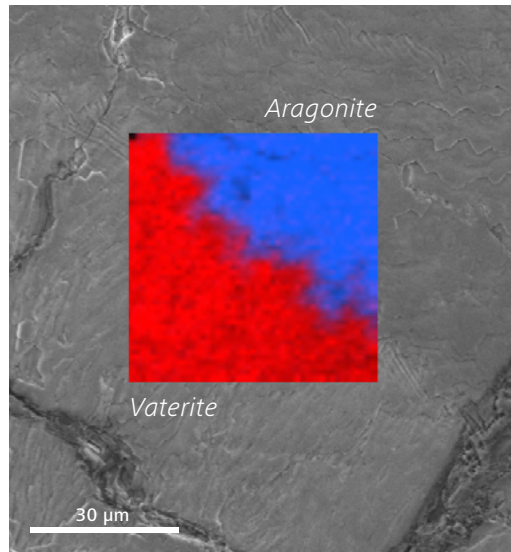

Pearl surface: This RISE image (left) makes it possible to differentiate between aragonite and vaterite phases. Both are CaCO₃ polymorphs that are present in milky pearls. They have the same chemical compositions, but different crystal structures (Raman spectrum, right). Aragonite and vaterite can be clearly differentiated by means of Raman spectra.

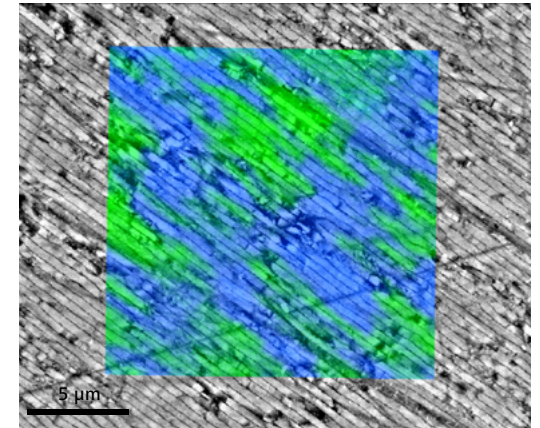

Polished cross-section of an abalone shell: Correlative RISE imaging shows the anisotropy of CaCO₃ in the aragonite phase. The anisotropy of the nacre layers are detected here, with blue and green representing anisotropic lattice distortions in biogenic crystals.

ZEISS Sigma at Work: Geosciences & Natural Resources

- › In Brief
- › The Advantages
- › **The Applications**
- › The System
- › Technology and Details
- › Service

From bulk chemistry over grain morphology to mineralogy, there are multiple questions to be answered when geoscientists investigate rocks, ores, minerals or other natural resources. Scanning electron microscopy combined with analytical capabilities and automation enable you to improve your understanding, process or modeling.

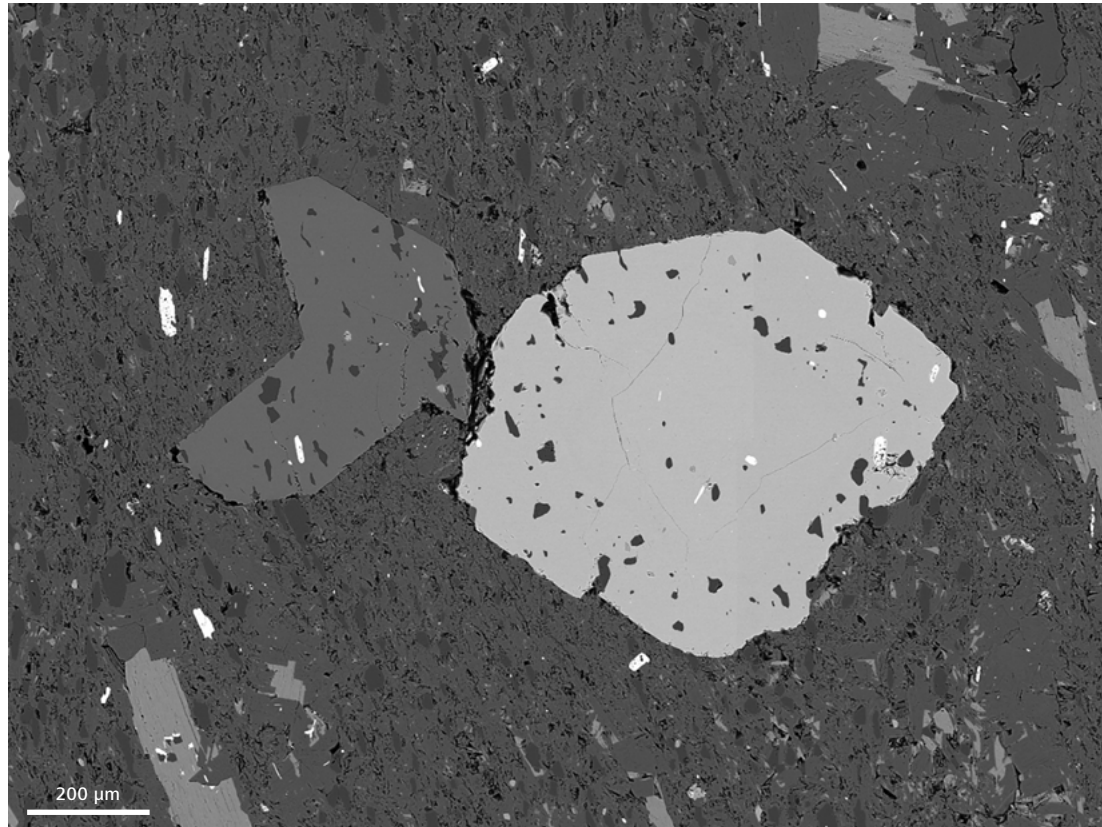

High resolution back-scattered electron (BSE) image at 20 kV of inclusion-bearing garnet and staurolite grains within a metamorphic schist sample from Weekeroo, South Australia.

Typical Tasks and Applications

- Characterize rocks and minerals: Image samples using techniques such as SE, BSE, and CL (cathodoluminescence).
- Combine imaging with geochemical analysis including EDS element mapping and WDS trace element analysis.
- Expand your analytical capabilities with correlated Raman spectroscopy, EBSD microstructure, and hyperspectral CL for defect and trace element valance state.
- Characterize particle sizes and phase distribution in rock sections and differentiate organic from inorganic materials.
- Investigate grain mounts, thin sections and core: perform imaging and high-speed analysis of non-conductive geological samples in variable pressure mode.
- Acquire high-definition compositional data of shale and minerals using the aBSD detector.
- Use flexible EDS detector configurations that allow high speed chemical analysis and unparalleled solid angle geometry.
- Achieve high throughput in central laboratories by taking advantage of the chamber geometry that allows for up to 16 samples to be mounted at once.
- Perform enhanced phase distinction: correlate chemical analyses with vibrational spectroscopy to distinguish polymorphs using RISE.

ZEISS Sigma at Work: Natural Resources

- › In Brief
- › The Advantages
- › **The Applications**
- › The System
- › Technology and Details
- › Service

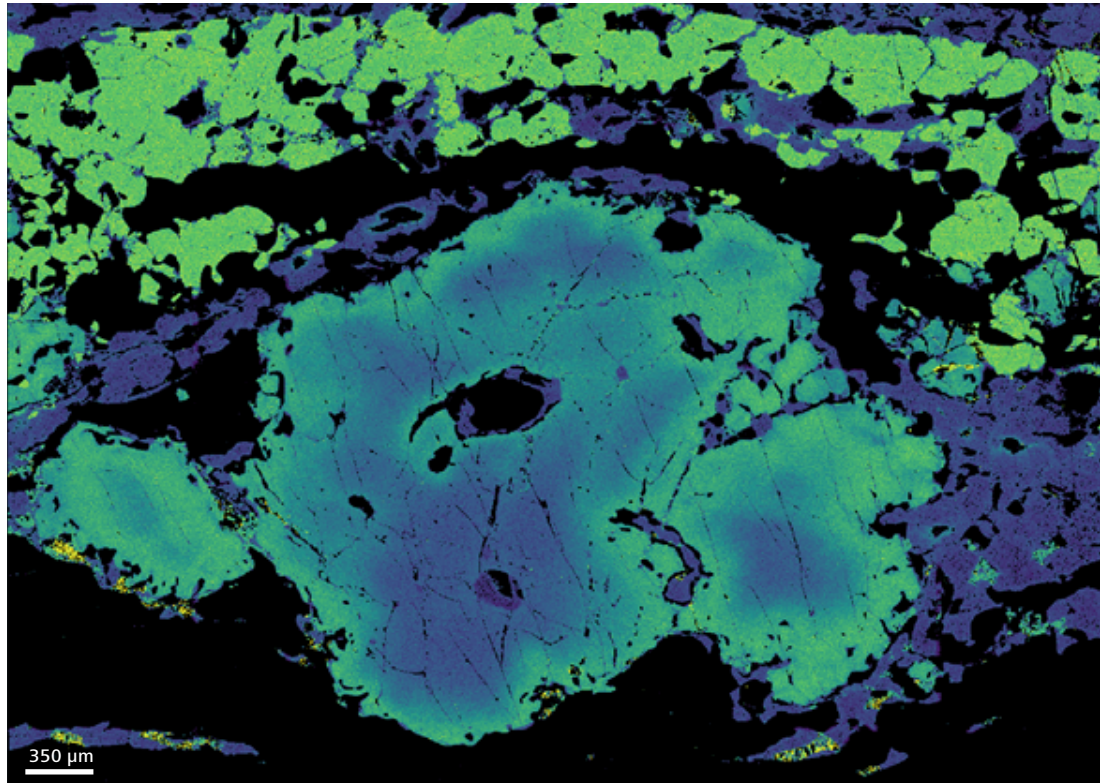

Quantitative EDS major element heatmap (Ca) or garnet-bearing gneiss highlighting geochemical zoning within key minerals.

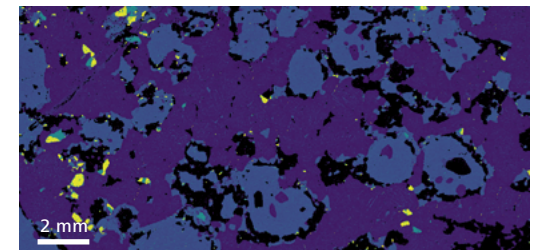
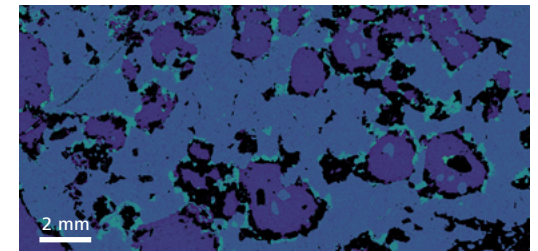
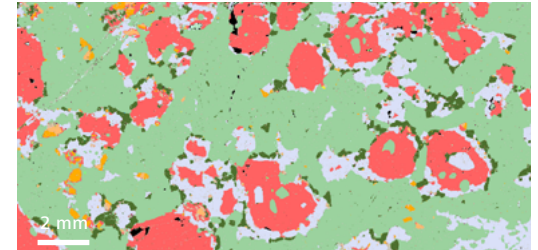
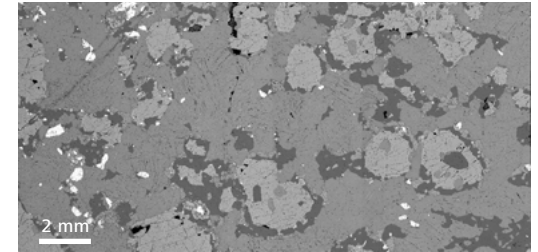

Rapidly map large areas such as full thin sections using multiple imaging modes including BSE and EDS for quantitative textural and geochemical analysis of a wide variety of sample types and workflows including petrology research, particle analysis and process mineralogy. Shown here from left to right Fe and Mg maps of a granulate facies rock from NW Scotland.

ZEISS Sigma at Work: Geosciences

- › In Brief
- › The Advantages
- › **The Applications**
- › The System
- › Technology and Details
- › Service

Raman Imaging of Geological Samples

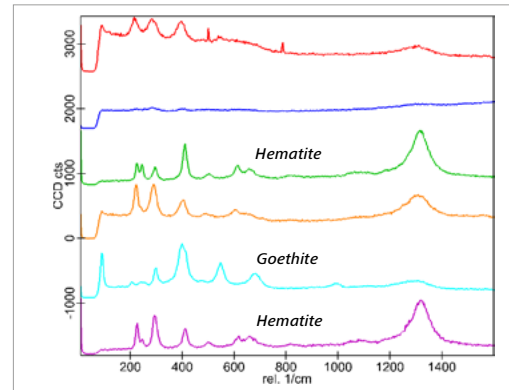
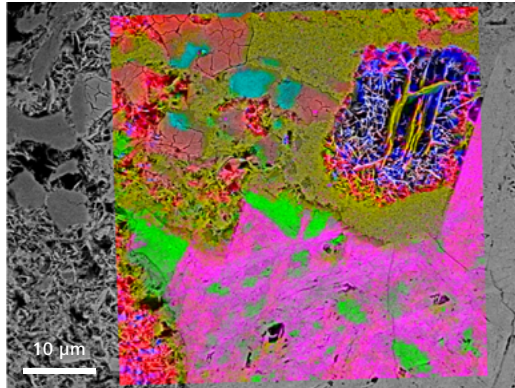

Iron Mineralogy

Raman identification of iron ore minerals (RISE image, left). Differences in the spectra of hematite are attributed to the different orientations of the crystals (Raman spectrum, right: hematite is red, blue, green, orange and pink; goethite is light blue).

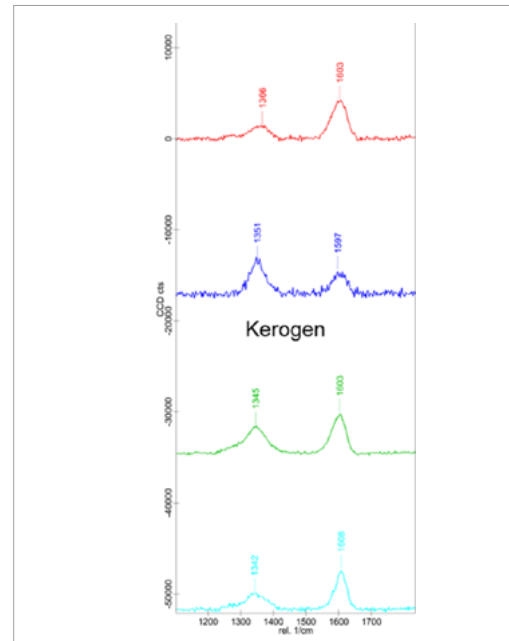
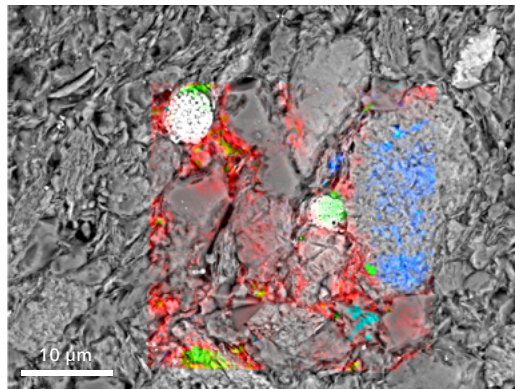

Shale Mineralogy

Kerogen is a mixture of organic chemical compounds that make up a portion of the organic matter in sedimentary rocks. Raman allows you to identify and classify organic material sitting in the interstices of mineral phases. Mostly composed of lighter elements, these organics would not have been easily recognized by an EDS analysis. Since the FWHM (full width at half maximum) of the kerogen G-band (centered around 1600 / 1/cm) has been shown to be indicative of thermal maturity, you can also use RISE to get this enhanced level of information.

ZEISS Sigma at Work: Microscopy in Industry

- › In Brief
- › The Advantages
- › **The Applications**
- › The System
- › Technology and Details
- › Service

Industrial quality analysis demands reproducibility and reliability. Only then can you be sure that the factory meets a defined, measurable and documented standard of quality. Your key task is to identify the root cause of any problem as quickly as possible, helping you decide which actions you need to take as part of good manufacturing practice.

The assembly of different components and materials can be a source of defects. To pinpoint system failures, you might need to employ a variety of methods and applications. That's why classic surface fracture and metallographic analyses are state-of-the-art practice, along with methods ranging from electronic failure analysis to compositional purity investigations.



This image of zinc oxide dendrites aids detection of morphological changes in the electrodes of energy storage systems. Secondary electron imaging using the ETSE detector on Sigma.

Typical Tasks and Applications

- Perform failure analysis on mechanical, optical or electronic components from the micro- right down to the nanometer scale—for example, using the Inlens SE detector or other SE detectors.
- Characterize devices by studying not only their microstructure but also their composition and phase distribution, choosing from a suite of backscatter detectors for material contrast.
- Analyze fractures by investigating surfaces or polished cross-sections with high-resolution, high-contrast imaging correlated with analytics such as EDS, Raman or EBSD.
- Automate your workflow—for example, for particle analysis –and detect, investigate and characterize particles using SmartPI (VDA 19.1 and ISO 16232).
- Quantify the microstructure of materials for NEV (New Energy Vehicles) with the Materials Apps and the AI Toolkit of the ZEN core software suite.

ZEISS Sigma at Work: Microscopy in Industry

- › In Brief
- › The Advantages
- › **The Applications**
- › The System
- › Technology and Details
- › Service

Infrastructure Materials

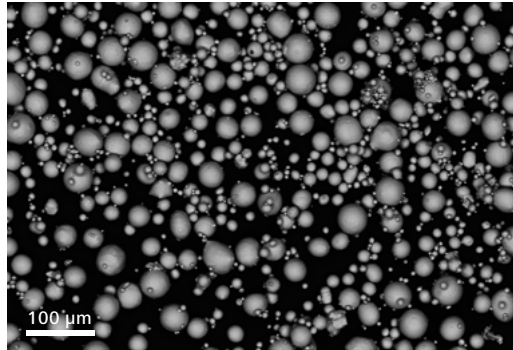

Titanium alloy (Ti-6Al-4V) powder for additive manufacturing or thermal spraying. Backscattered electron imaging on Sigma.

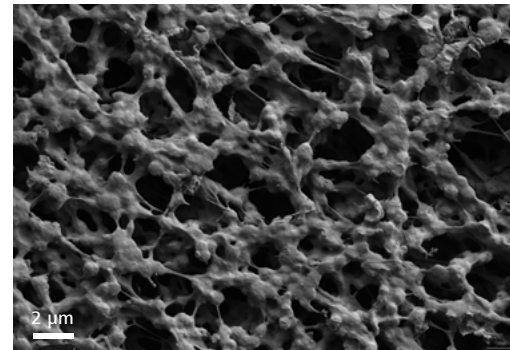

Filter paper used to filter diatoms from water, coated in a thin layer of gold. Image acquired at 2 kV with the ETSE detector.

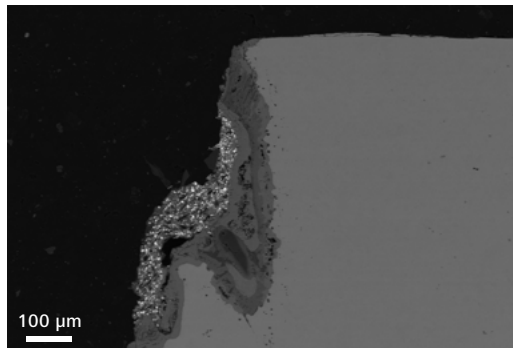

Corroded region of carbon steel with surface contamination, cross-section, backscattered electron imaging on Sigma.

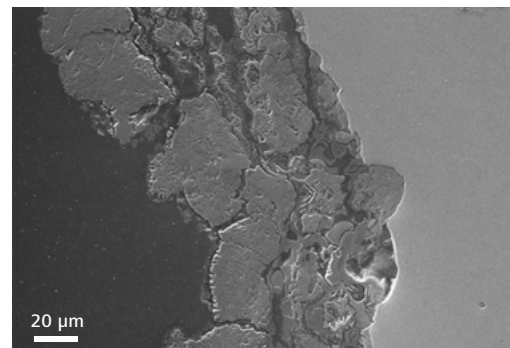

Heavily corroded region in failed pipe with high temperature corrosion and thinning. Image taken using C2D detector on Sigma at 50 Pa variable pressure.

Expand Your Possibilities

- › In Brief
- › The Advantages
- › **The Applications**
- › The System
- › Technology and Details
- › Service

Configure Your Stage – Choose from Eucentric or Cartesian

To allow complete flexibility of sample handling, Sigma 560 can be configured with either the eucentric or the Cartesian stage option. The eucentric stage offers a very stable, vibration-damped platform that delivers high resolution. Its mechanical eucentricity makes it easy to tilt your sample under the electron beam and is perfectly suited to high resolution imaging applications. The Cartesian stage with computerized movement comes into its own when you need to navigate bulky samples. Its modular design will accommodate extremely large and heavy samples – up to 5 kg in weight and 138 mm in height.*

The Cartesian stage is your first choice for demanding applications in fields like automotive, aerospace, metals or machinery.

**without spacer block and ZTR module*

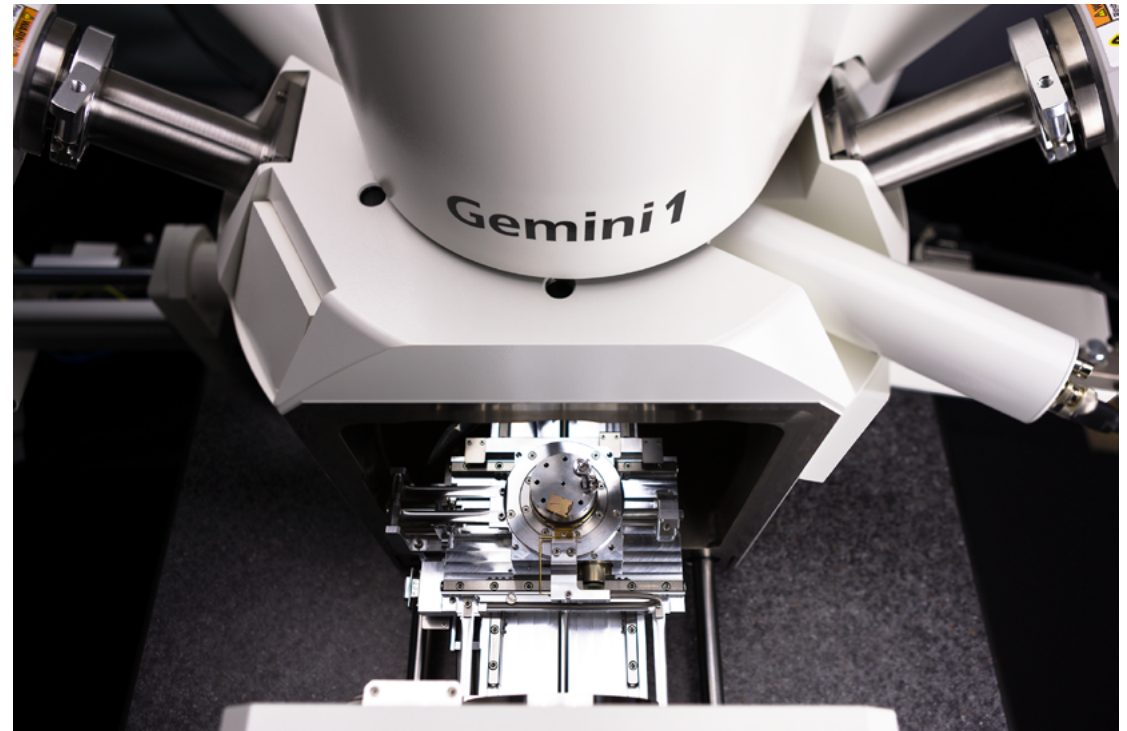

Sigma 560 with eucentric stage.

Parameter	Eucentric Stage	Cartesian Stage
Tilt	-4 to 70°	-10 to 90°
XY travel	130 mm	125 mm
Z travel	50 mm	38 mm
Weight	0.5 kg	0.5 kg XYZTR, 2 kg XYZR, 5 kg XY
Best for	High resolution imaging	Large, heavy samples
Applications	All high resolution applications (nanoparticles, thin films, etc.)	<ul style="list-style-type: none"> ■ Automotive piston QAQC ■ Aerospace turbine blade failure analysis ■ Inspection of large machined surfaces

Expand Your Possibilities

- › In Brief
- › The Advantages
- › **The Applications**
- › The System
- › Technology and Details
- › Service

***In Situ* Lab for ZEISS FE-SEM - Your Integrated Solution for Multi-modal *in situ* Experiments**

When you need to link materials performance to microstructure, ZEISS puts an automated *in situ* heating and tension experimental lab at your disposal. Observe materials under heat and tension automatically while plotting stress-strain curves on the fly.

Extend your Sigma with an *in situ* solution for heating and tensile experiments. Investigate materials like metals, alloys, polymers, plastics, composites, and ceramics.

Implement unattended automated *in situ* workflows. Combine a tensile or compression stage, a heating unit, and high-temperature detectors with EDS or EBSD.

Collect highly reproducible, precise, and reliable data with high throughput. Create statistically representative, user independent results. Process your data using digital image correlation.

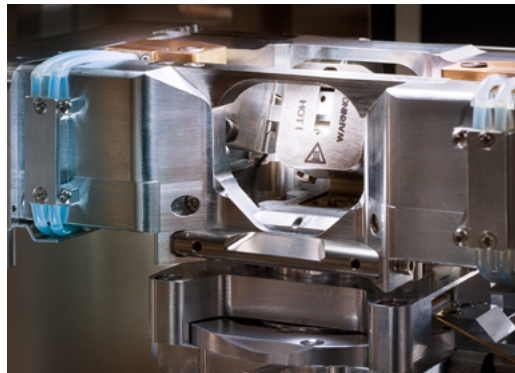

In situ tensile and heating stage. The sample is tilted to 70° for EBSD analysis. The heater is mounted beneath the sample for high temperature testing.

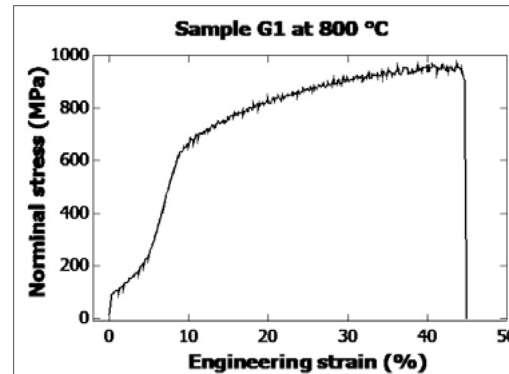

In situ mechanical tensile tests and EBSD analysis using specimens of Haynes 282, a wrought, γ' strengthened superalloy for high temperature structural applications resulting in grain misorientations and defects. A stress-strain curve is shown on the left. A series of EBSD maps on one of the ROIs is shown as an example using the *in situ* heating stage. The slip bands can be seen clearly. A cavity has formed close to the small green grain (EBSD) in the middle generating a concave area in the SEM image.

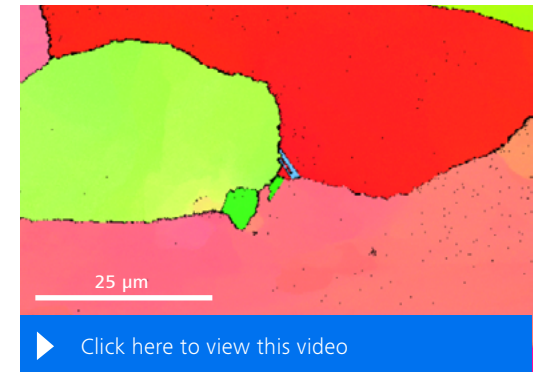

Expand Your Possibilities

- › In Brief
- › The Advantages
- › **The Applications**
- › The System
- › Technology and Details
- › Service

Make no Sacrifice to SEM Productivity even in Multi-user Environments

Depending on the actual laboratory environment, operation of the SEM can be the exclusive domain of expert electron microscopists. But this situation is challenged by the very common necessity that non-expert users, such as students, trainees, or quality engineers, also require data from the SEM. Sigma takes both requirements into account, with user interface options that cater to the operational needs of experienced microscopists as well as non-microscopists without sacrificing resolution or performance.



System administrator

This user is responsible for calibrating the system and preconfiguring parameters, and will have full access to the system controls.



Expert users Preferred UI: SmartSEM

Expert users have access to custom image directories, advanced imaging parameters, and analysis functions. They can have their own custom profiles that are independent from other user profiles.



Novice users Preferred UI: SmartSEM Touch

Novice users have access to custom image directories, predefined workflows and the most frequently used parameters—perfect for a beginner. They can have their own custom profiles that are independent from other user profiles.

Sigma perfectly meets the needs of multi-user environments with interface controls and options for users of different experience levels and access privileges.

Intuitive Operation: SmartSEM Touch

SmartSEM is ZEISS' well-established operating system for experienced microscopists that provides user access to advanced microscope settings. SmartSEM Touch is the highly simplified user interface developed specifically for the occasional operator who has very limited or no knowledge of operating an SEM. In as little as 20 minutes, novice users are up and running, producing their first SEM data. Laboratory managers can pre-configure parameters for recurring imaging routines, samples or parts, ensuring that novice or routine users always use the exact same parameters for repeatable data acquisition. Multiple languages are supported to ensure easy localization and use.

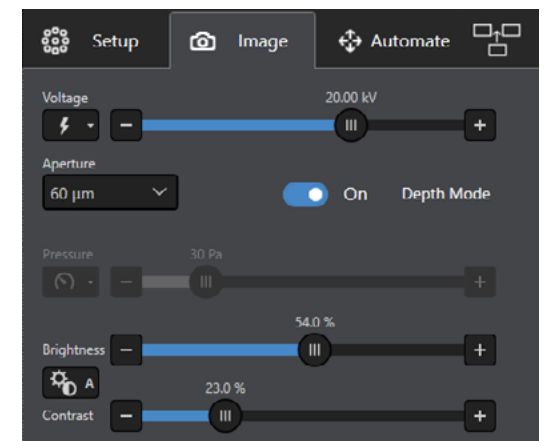

SmartSEM Touch: Intuitive user interface for access to presets, workflows, and imaging parameters

Expand Your Possibilities

- › In Brief
- › The Advantages
- › **The Applications**
- › The System
- › Technology and Details
- › Service

Image, Analyze, and Connect: Your Software for Connected Microscopy

ZEN core's software ecosystem handles more than just microscopy imaging. Whether in industry or academia, ZEN core is the most comprehensive suite of imaging, segmentation, analysis and data connectivity tools for multi-modal microscopy in connected laboratories.

Benefit from:

- One interface for all ZEISS microscopes in a multi-user environment: From stereo microscopes to automated imaging systems to electron microscopes, ZEN core provides a unified user interface for ZEISS microscopes. Perform multi-modal workflows. Correlate light and electron microscopy. Connect all imaging and analytical data between systems, and laboratories.
- Advanced imaging and automated analysis: Perform image acquisition routines and benefit from the consistency of an advanced and repeatable workflow. Execute analyses like EDS, EBSD or Raman spectroscopy and correlate all results. If suitable you can post-process your data with AI-based segmentation or classification.
- Infrastructure solutions for the connected laboratory: Link all of your ZEISS imaging and microscope solutions to a single, familiar graphic user interface (GUI). ZEN core provides the infrastructure for connected laboratory environments. Extract the maximum amount of meaningful information from your samples. The GUI is designed specifically for use in materials research and is available on all ZEISS electron and light microscopes with motorized stages.

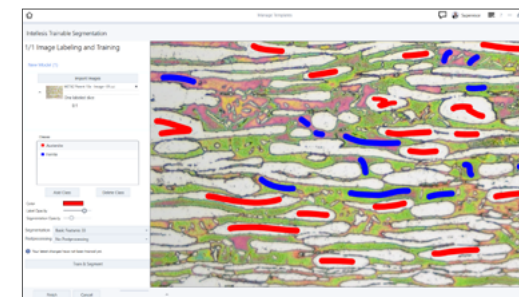

Use AI-based solutions in ZEN core. Teach the system how to segment images by labeling a few regions: simply paint them in.



Perform correlative or multi-modal microscopy. The user interface of ZEN core is specifically tailored to complex, sample-centric experimental setups. All images are visualized in what's known as a correlative workspace; multi-modal, multi-scale data can be aligned and put into context in a single ZEN Connect project – for example, correlate light microscope with SEM images and EDS maps.

Expand Your Possibilities

- › In Brief
- › The Advantages
- › **The Applications**
- › The System
- › Technology and Details
- › Service

ZEN core Packaging Structure: Simplified Access to Endless Possibilities

ZEN core provides a comprehensive end-to-end solution for any microscopy user. Even so, it is evolving continuously to address emerging applications with added features such as automated smart acquisition, intuitive image analysis and cloud-based data management.

That's why the newest version of ZEN core comes with simplified options that make the numerous capabilities of the software more accessible. ZEN core modules with great synergy have been consolidated into a simple set of tailored Acquisition and Application toolkits and packages.

Toolkit		Description
2D Toolkit	Image Analysis	Toolkit for 2D image analysis by creation of automatic measurement programs.
	Advanced Processing	Advanced processing functions included
AI Toolkit	ZEN Intellesis Segmentation	Complete package for AI application including integrated training interfaces: <ul style="list-style-type: none"> ■ Automated image segmentation based on machine learning algorithms ■ Automated object classification of segmented and analyzed images based on machine learning algorithms ■ AI-based denoising of images using noise-2-void algorithms
	ZEN Intellesis Object Classification	
	ZEN Intellesis AI denoising	
Connect Toolkit	ZEN Connect	Complete Connect package to extend the ZEN Connect functionality. Includes L-marker calibration for correlative LM to EM workflows and functionality for 3D data. Import 3 rd -party microscopy images and metadata into ZEN core using Bio-Formats included.
	ZEN Connect 2D Add-on	
	ZEN Connect 3D Add-on	
	Third-party Import	
Application Toolkits		Description
Materials Apps	Grain Size Analysis	Package for materials applications: <ul style="list-style-type: none"> ■ Determine grain sizes via different methods according to international standards ■ Analyze form, size and distribution of graphite particles in cast iron ■ Automated measurement of particle size and area content of multiphase samples, evaluation of porosity ■ Compare micrographs with standardized or customizable comparative charts (Wall Charts) ■ Automated or interactive thickness measurement of different layers <p>AI "Ready" – pre-trained models can be run to evaluate data. They cannot be created or modified – these tasks require the AI Toolkit or for Deep learning based models a subscription to APEER ML</p>
	Cast Iron Analysis	
	Multiphase Analysis	
	Comparative Diagrams	
	Layer Thickness Measurement	
NMI	Non-Metallic Inclusion Analysis	Automated imaging, classification and reporting of non-metallic inclusions in steel
TCA	Technical Cleanliness Analysis	Automated identification and classification of particles compliant to cleanliness standards
Automated Imaging	Automated Imaging	Acquire large EM tiles images on ZEISS FE-SEMs via defined imaging protocols

Optional packages of ZEN core. These toolkits are recommended for materials researchers, covering essential workflows such as 2D image acquisition, AI-based image analyses, multi-modal experiments, materials applications and industry-specific tasks such as technical cleanliness.

Expand Your Possibilities

- › In Brief
- › The Advantages
- › **The Applications**
- › The System
- › Technology and Details
- › Service

From Image to Information Realized by Customization and Automation. ZEISS Solutions Lab.

Let's say you have just bought a new microscopy system from ZEISS, or perhaps it's multiple systems chosen to deliver a whole suite of correlated data across length scales. The possibilities are endless and you're itching to get to work. Where do you start? Let us help. Contact us for access to our powerful Solutions Lab app. Or say the word and we'll work with you to develop a solution tailored precisely to your needs.

Problems we can help you solve:

- Customizing workflows to your configuration, including jobs, reporting and result representation
- Automating your imaging workflows
- Automating the search for ROIs (region of interest)
- Developing solutions that turn 20 clicks into one executing image analyses that produce AI-ready results
- Performing AI-based workflows to ensure reproducible results compliant with international standards across laboratories
- Providing customized tools for materials research to investigate grain sizes, cast iron or layer thickness – the Materials Apps application toolkit
- Developing your own models using the latest AI technology without the need for coding.

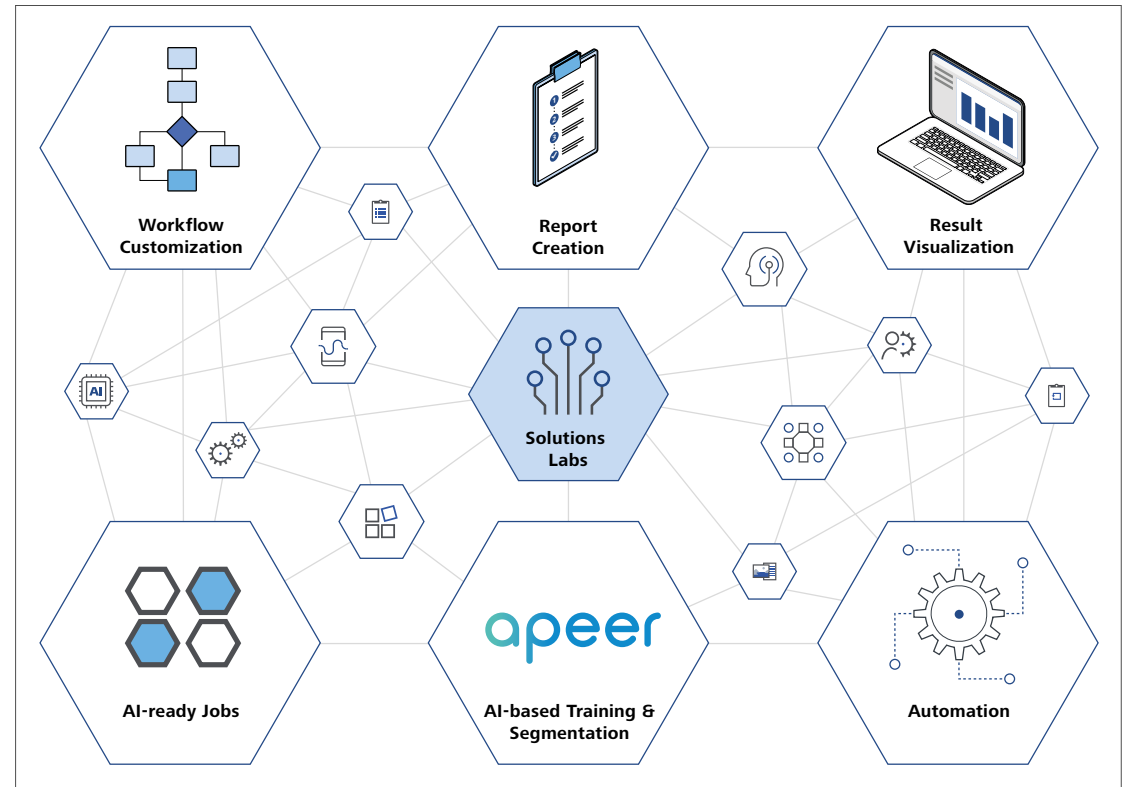

Artificial Intelligence-based algorithms readily provided to help you maximize efficiency. Start from customized apps within Solutions Lab and benefit from being able to connect to ZEN core or APEER.

Expand Your Possibilities

- › In Brief
- › The Advantages
- › **The Applications**
- › The System
- › Technology and Details
- › Service

Get Quick Quantitative Information About Your Sample Surface Topography with 3DSM

Perform live, real-time surface modelling. Put user-friendly 3DSM software together with the aBSD4 detector to acquire a quantitative 3D model of your surface with a single click. The underlying "shape-from-shading" algorithm handles the reconstruction, using individual images taken by each of the four segments of the outer ring of the aBSD. The resulting 3D model will be visualized so you can perform basic measurements such as profile dimensions, and 2D- and 3D roughness evaluations directly — with just a few mouse clicks. For more sophisticated analysis methods, simply hand over the as-generated 3D model to the optional Mountains® software.

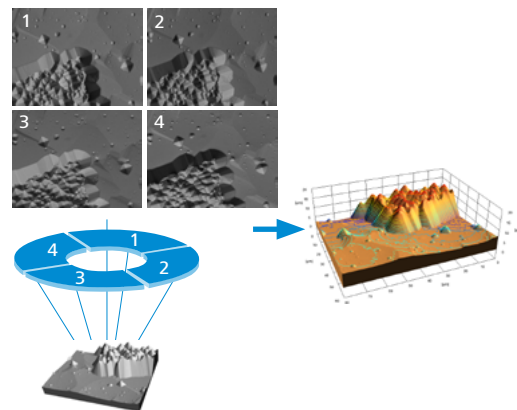

Working principle of the 3DSM method. Initially, separate images are acquired by each of the four segments of the diode, respectively. Different gradients of gray levels in each image can then be used to calculate the local height profile of the sample line by line.

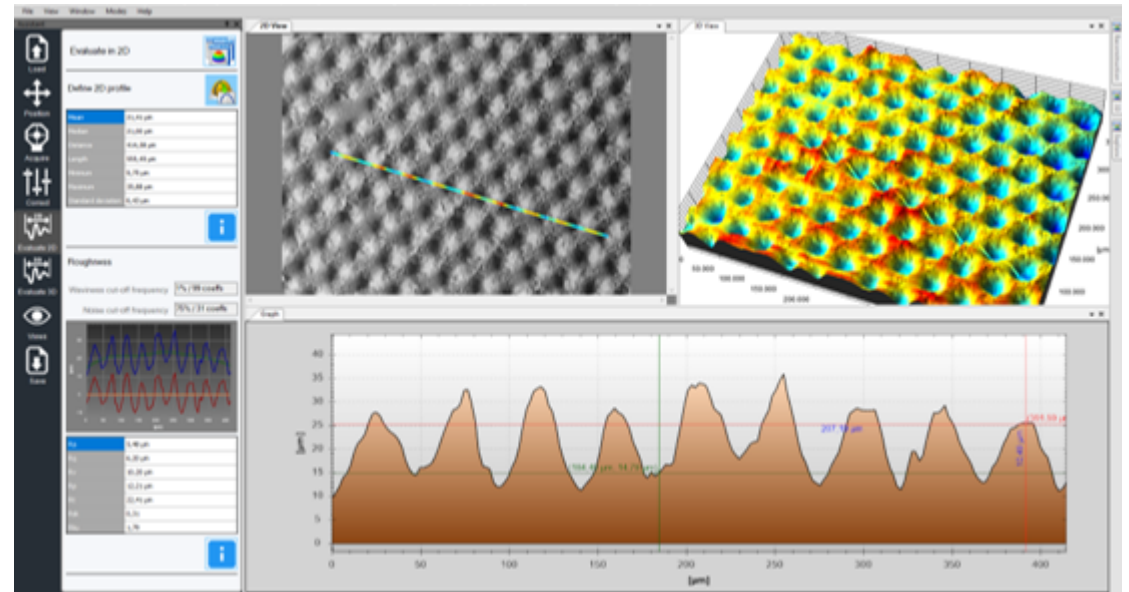

3D reconstruction of a "water-repelling" polyurethane film by roll-to-roll imprinting. 3D model of the surface, profile evaluation, and 2D- and 3D roughness determinations for quantitative assessment. Sample: courtesy of G. Umlauf, Fraunhofer IGB, Stuttgart, DE.

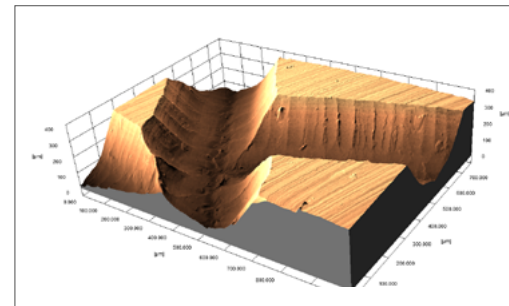

3D model of a machined and engraved steel surface.

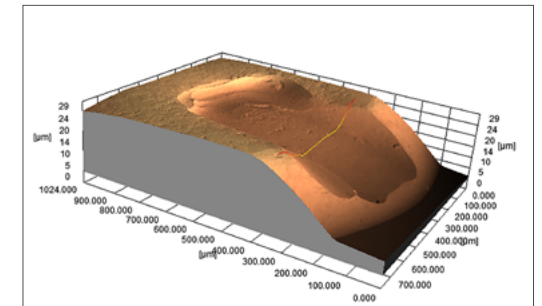

3D model of an imprint of the firing-pin left on a bullet.

Expand Your Possibilities

- › In Brief
- › The Advantages
- › **The Applications**
- › The System
- › Technology and Details
- › Service

Technical Cleanliness Solution for Electron Microscopy

Identify the root cause and make the right decision faster. ZEISS SmartPI has been designed for repeatable, high-volume analysis of routine samples in a production environment. The ability to identify, analyze and report contamination data, creates a new dimension in process control. Take the next step forward in Technical Cleanliness with ZEISS SmartPI – which now includes the support for Oxford EDS detectors. Benefit from significant improvements in fully automated SEM Particle Analysis and Classification. Increase your productivity and quality and reduce your contamination cost.

Your Advantages at a Glance

- Powerful, versatile, all-in-one particle analysis application for your ZEISS Sigma family.
- A complete turnkey solution, which fully automates repetitive sample analysis and provides non-subjective results, with minimal user interaction.
- Full control of the SEM, advanced image processing, image analysis and elemental analysis (EDS) – all driven from a single application.
- Automatically detects, measures, counts and classifies particles of interest, based on morphology and elemental composition.
- Industry standard reports are automatically generated, like VDA 19.1 and ISO 16232.
- Fully integrated & compatible with Bruker and Oxford EDS systems.
- Supports Correlative Automated Particle Analysis with ZEISS Light Microscopes.



Electron Microscopy
with EDS

HARDWARE



✓ Run-up



ZEISS SmartPI
Quantification & advanced classification

SOFTWARE

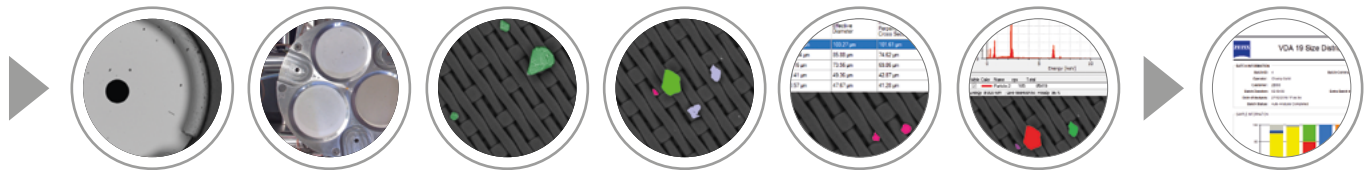

✓ Calibrate

✓ Move

✓ Capture

✓ Detect

✓ Measure

✓ Analyze

✓ Report



Reporting
SmartPI Reporter

Expand Your Possibilities

- › In Brief
- › The Advantages
- › **The Applications**
- › The System
- › Technology and Details
- › Service

Automated Mineralogy

ZEISS Mineralogic 2D provides SEM-based automated quantitative mineralogy (AQM) via a combination of high-resolution SEM imaging and EDS. Mineralogic is a versatile system designed for analytical precision and flexibility. Any imaging detector (SE, BSD, CL, etc.) may be used on its own, or in combination, to define your area to be analyzed before performing a quantitative chemical analysis to automatically classify mineral phases, based on their chemical composition, and provide detailed outputs on morphology, chemistry, liberation, and textural parameters.

Use Mineralogic 2D for:

- Quantitative chemical analysis and classification
- Morphochemical and lithological classification
- Geochemical investigation
- Ore body characterization
- Mining specific outputs

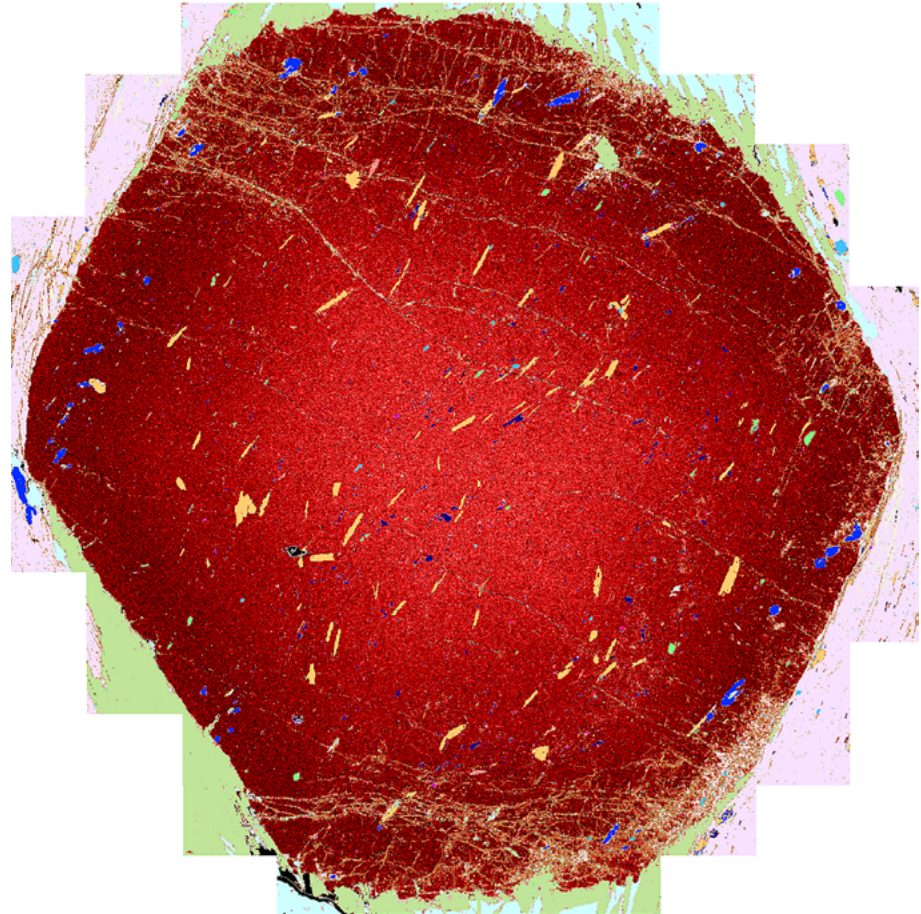

Zoned garnet from Loch Lomond, Scotland. Elemental mapping combines geochemical variation with phase identification of the evolving inclusion assemblage, charting the geological history.

Your Flexible Choice of Components

- › In Brief
- › The Advantages
- › The Applications
- › **The System**
- › Technology and Details
- › Service

Selected Detectors	Offerings	ZEISS Sigma 360	ZEISS Sigma 360 VP	ZEISS Sigma 560	ZEISS Sigma 560 VP
Inlens SE Detector	High resolution in column topographical imaging	●	●	●	●
Inlens Duo Detector	High resolution in column sequential topographical or compositional imaging (replaces Inlens SE Detector)	X	X	○	○
ETSE Detector	High vacuum topographical imaging at longer working distance	●	●	●	●
VPSE G4 Detector	Fourth generation Variable Pressure SE detector	X	○	X	○
C2D G2	Current cascade detector (2 nd generation) for high performance Variable Pressure imaging	X	○	X	○
AsB Detector, mounted to the objective	Compositional and crystallographic orientation imaging	○	○	○	○
aBSD1/4 Detector	Backscattered electron detector with up to 4 parallel channels for fast compositional and topographical contrast imaging at low voltage. Enables quantitative 3D surface reconstruction.	○	○	○	○
NanoVP lite aBSD1	NanoVP lite variable pressure imaging with high efficiency 5-sector annular solid-state BSE detector	X	○	X	○
5S HDBSD Detector	5 segment high definition BSE detector for compositional imaging	○	○	○	○
Sense BSD	Solid state detector for low kV BSE detection & high speed	○	○	○	○
YAG BSD Detector	YAG crystal scintillator BSE detector for fast, easy-to-use compositional imaging	○	○	○	○
aSTEM Detector	Annular STEM for transmission imaging	○	○	○	○
CL Detector	Cathodoluminescence detector	○	○	○	○
Recommended Accessories					
Airlock	Fast loading of samples up to 80 mm diameter	○	○	○	○
Large Airlock	Fast loading of samples up to 160 mm diameter	○	○	○	○
Plasma Cleaner	Remove hydrocarbon contamination for high resolution imaging	○	○	○	○
SmartEDX Detector	Dedicated ZEISS energy dispersive X-ray analysis solution for microanalysis applications	○	○	○	○
EBSD Detector	Electron backscatter diffraction detector for microstructural-crystallographic analysis	○	○	○	○
EDS Detector	Energy dispersive X-ray analysis for high resolution compositional analysis	○	○	○	○
WDS Detector	Wavelength dispersive spectroscopy for high resolution low artefact compositional analysis	○	○	○	○
RISE	Integrated solution for confocal Raman imaging	○	○	*	*
Recommended Software					
3DSM	3D quantitative solutions for 3D reconstructions of your sample surface and for local roughness analysis.	○	○	○	○
Mineralogic Mining	Advanced mineral analysis engine	○	○	○	○
SmartSEM Touch	Simplified user-interface for multi-user environments	○	○	○	○
SmartPI	Automated particle analysis	○	○	○	○
ZEN core	Software suite for microscope image acquisition, processing, analysis, and data connectivity.	○	○	○	○

● Standard ○ Option available X Not available * Available as special customer solution

Technical Specifications

- › In Brief
- › The Advantages
- › The Applications
- › The System
- › **Technology and Details**
- › Service

	ZEISS Sigma 360	ZEISS Sigma 560
Electron Source	Schottky Thermal Field Emitter	Schottky Thermal Field Emitter
Resolution* at 30 kV (STEM)	1.0 nm	0.8 nm
Resolution* at 15 kV	0.9 nm	0.7 nm
Resolution* at 15 kV / DCV**	0.7 nm	0.5 nm
Resolution* at 1 kV	1.3 nm	1.2 nm
Resolution* at 1 kV / DCV**	1.1 nm	1.0 nm
Resolution at 500 V	1.9 nm	1.5 nm
Resolution* at 30 kV (VP Mode)	2.0 nm	1.5 nm
Backscatter Detector (BSD)	aBSD / HDBSD / NanoVP lite-aBSD1	aBSD / HDBSD / NanoVP lite-aBSD1
Maximum Scan Speed	50 ns/pixel	50 ns/pixel
Accelerating Voltage	0.02 – 30 kV	0.02 – 30 kV
Magnification	10x – 1,000,000x	10x – 1,000,000x
Field of View***	4.6 mm	4.6 mm
Probe Current	3 pA - 20 nA (100 nA optional)	3 pA - 20 nA (100 nA optional)
Image Framestore	32 k x 24 k pixels	32 k x 24 k pixels
Ports	10	14
EDS Ports	2 (1 dedicated port)	3 (2 dedicated ports)

* optimum working distance (WD); upon final installation, the resolution is proven without deconvolution in the systems acceptance test at 1 kV and 15 kV in high vacuum

** deconvoluted

*** maximum FOV at 5 kV high vacuum and WD = 8.5 mm

Vacuum Modes

High Vacuum	Yes	Yes	
Standard VP / NanoVP lite	10 – 133 Pa	10 – 133 Pa	
Stage Type	5 axis compucentric stage	5 axis eucentric stage	5 axis compucentric stage option
Stage travel X	125 mm	130 mm	125 mm
Stage travel Y	125 mm	130 mm	125 mm
Stage travel Z	50 mm	50 mm	38 mm
Stage travel T	-10 to +90 degrees	-4 to +70 degrees	-10 to +90 degrees
Stage travel R	360° Continuous	360° Continuous	360° Continuous

ZEISS Service – Your Partner at All Times

Your microscope system from ZEISS is one of your most important tools. For over 175 years, the ZEISS brand and our experience have stood for reliable equipment with a long life in the field of microscopy. You can count on superior service and support - before and after installation. Our skilled ZEISS service team makes sure that your microscope is always ready for use.

- › In Brief
- › The Advantages
- › The Applications
- › The System
- › Technology and Details
- › **Service**

Procurement

- Lab Planning & Construction Site Management
- Site Inspection & Environmental Analysis
- GMP-Qualification IQ/OQ
- Installation & Handover
- IT Integration Support
- Startup Training

Operation

- Predictive Service Remote Monitoring
- Inspection & Preventive Maintenance
- Software Maintenance Agreements
 - Operation & Application Training
 - Expert Phone & Remote Support
- Protect Service Agreements
 - Metrological Calibration
 - Instrument Relocation
 - Consumables
 - Repairs

New Investment

- Decommissioning
- Trade In

Retrofit

- Customized Engineering
- Upgrades & Modernization
- Customized Workflows via ZEISS arivis Cloud



Please note: Availability of services depends on product line and location

www.zeiss.com/microscopy/service



Carl Zeiss Microscopy GmbH
07745 Jena, Germany
microscopy@zeiss.com
www.zeiss.com/sigma

Follow us on social media:

