

MCS FLEX
Unstoppable

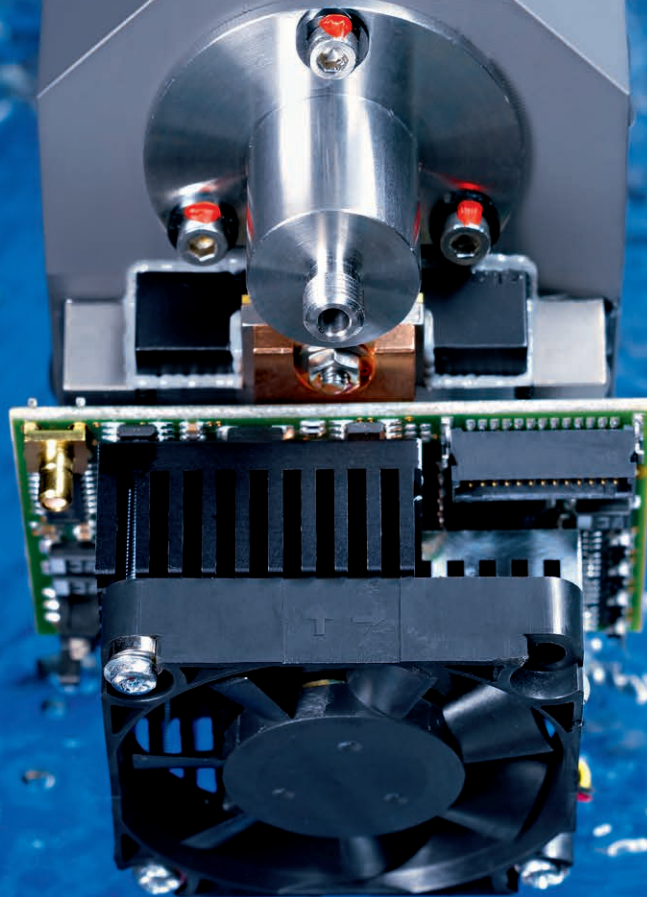

Multi Channel Spectrometer from ZEISS



MCS FLEX Multi Channel Spectrometer

MCS FLEX PDA (190–1015 nm) and
MCS FLEX CCD (190–980nm)

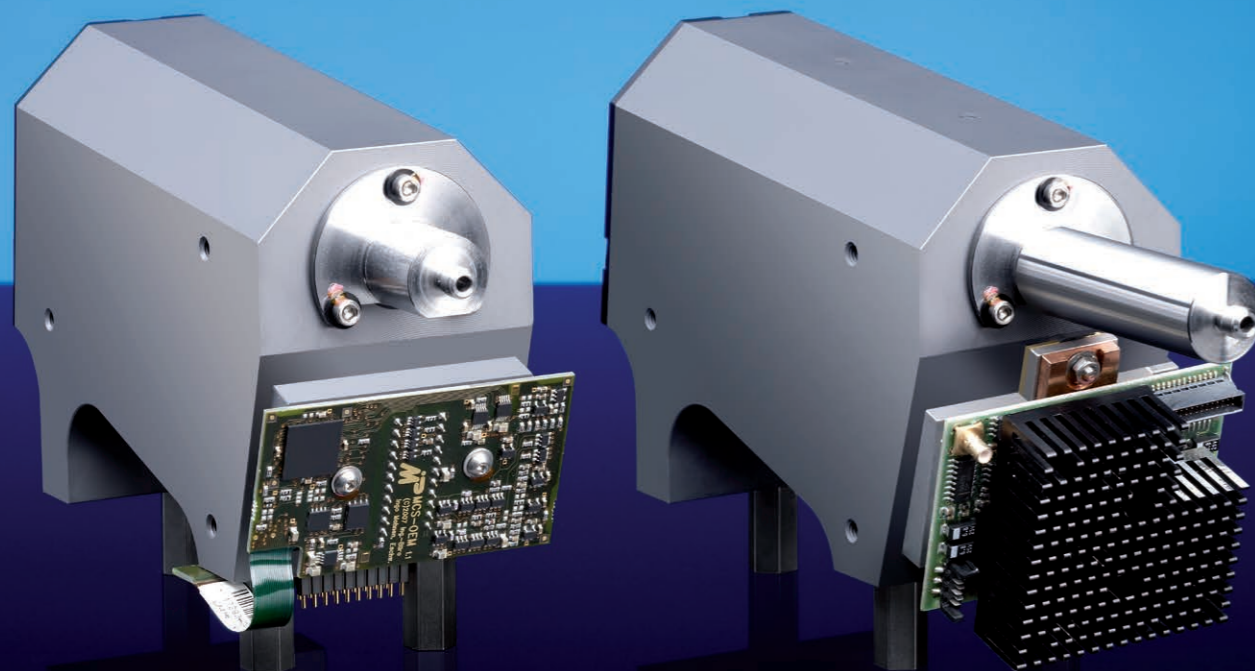

Built-in Flexibility

Obstacles can be avoided or eliminated – provided you have the flexibility to act. The new housing structure of the MCS FLEX now allows much more flexible integration of the spectrometer module into your measuring systems and overcomes all obstacles.

The MCS FLEX employs an imaging grating, an optical input and a CCD or PDA sensor array. The core of the spectrometer is a blazed flat-field grating for light dispersion and imaging. The overall configuration results in a spectral pixel pitch of 0.8 nm/pixel, enabling a spectral resolution of better than 3 nm, in accordance with the Rayleigh criterion. The optical input is an SMA connector with an integrated fiber cross section converter.

All of the optical components are mounted in a housing made of a special alloy. The housing can now be placed to the users' measuring systems with much more flexibility.

The special alloy of the housing completes the excellent thermal properties of the MCS FLEX. With their compact size and low weight, the spectrometer modules are ideally suited for mobile measuring systems. Their excellent thermal stability and very low amount of stray light ensure reliable measuring results even in rough environments.



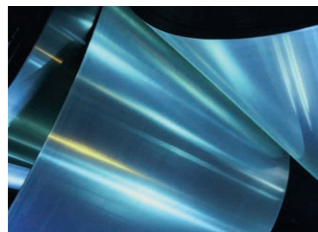

Depending on the sensor array, the modules are offered as MCS FLEX CCD (190–980 nm) or MCS FLEX PDA (190–1015 nm).



Areas of application

The spectrometer modules can be integrated close to the process and are extremely versatile. Their applications range from thickness measurements of thin layers and chemical analyses to the characterization of light sources and deployment as HPLC detectors. They are ideal for process and quality control, monitoring or calibration. Furthermore, the high light sensitivity of the MCS FLEX CCD enables its use for fluorescence measurements in microscopy or special layer thickness measurements in the semiconductor industry.

What is new in the MCS FLEX?

-  More flexible module placement
-  Lower temperature drift
-  Less stray light
-  More compact design
-  Considerably less weight

Technical Specifications

	MCS FLEX CCD	MCS FLEX PDA
Optical Entrance	Cross Section Converter	Cross Section Converter
CSC version	Diameter: 0.5 mm NA = 0.22 (has to be filled for full specification) mounted in SMA-coupling	Diameter: 0.5 mm NA = 0.22 (has to be filled for full specification) mounted in SMA-coupling
Grating	Flat-field correction 248 l/mm (center) blazed for approx. 250 nm	Flat-field correction 248 l/mm (center) blazed for approx. 250 nm
Spectral range	190–980 nm	190–1015 nm
Wavelength accuracy absolute	0.5 nm	0.5 nm
Reproducibility	≤ 0.1 nm	≤ 0.1 nm
Temperature – induced drift	< 0.009 nm/K	< 0.009 nm/K
Spectral distance of pixel	$\Delta l_{\text{Pixel}} \approx 0,8 \text{ nm}$	$\Delta l_{\text{Pixel}} \approx 0,8 \text{ nm}$
Resolution (FWHM: Full width half maximum)	$\Delta l \approx 3-4 \text{ nm}$	$\Delta l \approx 3-4 \text{ nm}$
Straylight:	< 0.1 % measured at 340 nm with Deuterium lamp (transmission of NaNO ₂ solution, 50 g/l, 1 cm)	< 0.1 % measured at 340 nm with Deuterium lamp (transmission of NaNO ₂ solution, 50 g/l, 1 cm)
Dimensions	198 x 68 x 122 mm (long Cross Section Converter) 160.3 x 68 x 122 mm (short Cross Section Converter)	160.3 x 62 x 122.2 mm

Dimensional drawing MCS FLEX CCD

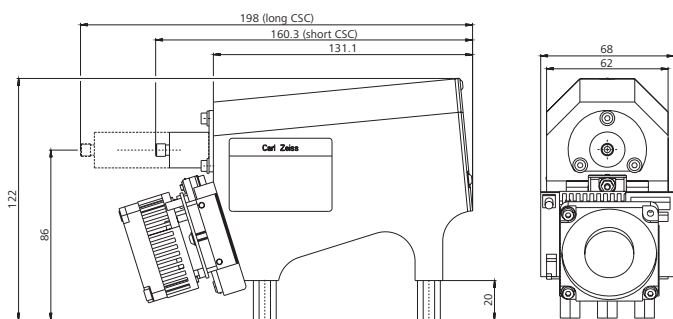

Dimensional drawing MCS FLEX PDA

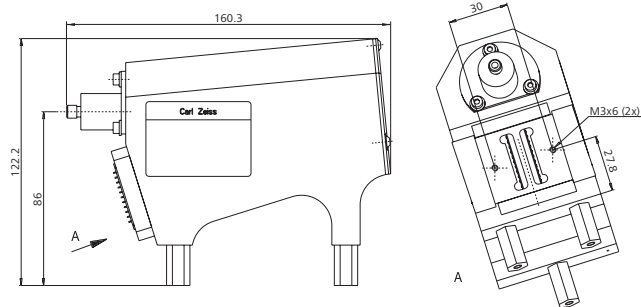

Carl Zeiss Spectroscopy GmbH

Carl-Zeiss-Promenade 10
07745 Jena, Germany

Phone: + 49 3641 64-2838
Fax: + 49 3641 64-2485

Email: info.spectroscopy@zeiss.com
www.zeiss.com/spectroscopy